



**138**

**Unterklassen-Ausstattung**

Subclass parts

Composition des sous-classes

Composición de las subclases

Unterklasse Subclass Sous-classe Subclasse	Ausführung Model Version Tipo de máquina	Überstichbreite in mm Stitch width in mm Jeu de l'aiguille en mm Anchura del zigzag en mm	Nadelstange Needle bar Barre à aiguille Barra de aguja	Nadelhalter Needle holder Pince-aiguille Portaagujas	Stoffschleber <sup>4</sup> Feed dog Griffe Transportador inferior
-6/21	B	4,5 6,0	91-013 165-91		91-026 884-05 91-026 891-05
-6/21-915/02	B	<sup>10</sup> = 4,5 mm	91-064 652-91		91-026 884-05
-6/21-915/02	B	<sup>10</sup> = 6,0 mm	91-064 652-91		91-026 891-05
-6/21-915/05	B	<sup>10</sup> = 4,5 mm <sup>10</sup> = 6,0 mm	91-064 653-01	91-063 148-91	91-026 884-05 91-026 891-05
-34/01	A; B	3,0; 4,5; 6,0	91-013 165-91		91-047 401-04 <sup>11/2</sup>
-45/01-915/02	A; B	<sup>10</sup> = 4,5 mm	91-064 652-91		91-026 883-05 A 91-026 884-05 B
-45/01-915/05	A; B	<sup>10</sup> = 4,5 mm	91-064 653-01	91-063 148-91	91-026 883-05 A 91-026 884-05 B
-45/02-915/02	A; B	<sup>10</sup> = 4,5 mm	91-064 652-91		91-026 883-05 A 91-026 884-05 B
-45/02-915/05	A; B	<sup>10</sup> = 4,5 mm	91-064 653-01	91-063 148-91	91-026 883-05 A 91-026 884-05 B
-66/01	B	4,5	91-013 165-91		91-026 631-05
-275/01	A	3,0	91-013 165-91		91-026 833-04
-277/01	A	3,0	91-013 165-91		91-026 833-04

<sup>1)</sup> Die Liste enthält nur Nähwerkzeuge und Apparate. Beim Umbau in eine andere Unterklasse oder Ausführung sind auch noch Maschinenteile erforderlich. Geben Sie also bei Bestellungen die genaue Bezeichnung der vorhandenen und der gewünschten Ausführung bekannt.

<sup>1)</sup> This list contains sewing parts and attachments only. When converting to another subclass or version, machine parts are also necessary. When ordering please therefore indicate exactly the existing version and the one required.

<sup>1)</sup> Cette liste ne contient que les organes de couture et les guides. En cas de transformation en une sous-classe ou variante différente, il faut utiliser aussi certaines pièces de machine supplémentaires. En cas de commande, prière de toujours indiquer par conséquent les variantes disponibles et souhaitées.

<sup>1)</sup> Esta lista sólo contiene elementos de costura y aparatos. Siempre que haya que transformar la máquina en otro tipo o subclase, se necesitarán también piezas de máquina, por lo que deberá indicarse en los pedidos el tipo exacto de que se dispone y el deseado.

<sup>4</sup> = Ausführung angeben  
= Indicate model  
= Préciser la version  
= Indiquese el tipo

<sup>10</sup> = Nadelabstand  
= Needle gauge  
= Ecartement des aiguilles  
= Distancia entre agujas

<sup>22</sup> = Zubehör  
= Accessories  
= Accessoires  
= Accesorios

<sup>5</sup> = Nähmuster einsenden  
= Submit sewing sample

<sup>11/2</sup> = Überstichbreite bei Bestellung angeben  
= Indicate max. stitch width on order

Stichplatte Needle plate Plaque à aiguille Placa de aguja	Nähfuß Presser foot Pied presseur Pie prensateelas	Apparat Attachment Appareil Aparato	Überdeckplatte Cover plate Plaque de recouvrement Plaquita para nervuras	Fingerschutz Finger guard Protège-doigts Salvadedos	Bandtrommel Tapa reel Tambour-dérouleur Tambor portecintas
91-026 881-04	91-043 522-03			91-053 750-25	
91-026 888-04	91-051 998-03				
91-026 881-04	91-043 522-03				
91-026 888-04	91-051 998-03			91-053 750-25	
91-026 881-04	91-043 522-03			91-053 750-25	
91-026 888-04	91-051 998-03				
91-048 932-04 <sup>(117)</sup>	91-054 713-03 <sup>(117)</sup>			91-053 749-25	
91-046 313-03	91-041 283-93		91-041 844-25 <sup>(22)</sup>	91-053 750-25	
	91-051 276-04 <sup>(22)</sup>		91-041 845-21 <sup>(22)</sup>		
	91-051 280-04 <sup>(22)</sup>		91-105 997-21 <sup>(22)</sup>		
91-046 313-03	91-041 283-93		91-041 844-25 <sup>(22)</sup>	91-053 750-25	
	91-051 276-04 <sup>(22)</sup>		91-041 845-21 <sup>(22)</sup>		
	91-051 280-04 <sup>(22)</sup>		91-105 997-21 <sup>(22)</sup>		
91-046 313-03	91-041 283-93		91-041 842-25 <sup>(22)</sup>	91-053 750-25	
	91-051 276-04 <sup>(22)</sup>		91-105 996-21 <sup>(22)</sup>		
	91-051 280-04 <sup>(22)</sup>		91-042 586-21 <sup>(22)</sup>		
91-046 313-03	91-041 283-93		91-041 842-25 <sup>(22)</sup>	91-053 750-25	
	91-051 276-04 <sup>(22)</sup>		91-105 996-21 <sup>(22)</sup>		
	91-051 280-04 <sup>(22)</sup>		91-042 586-21 <sup>(22)</sup>		
91-026 512-04	91-051 186-93	91-040 373-23			
91-026 877-04	91-053 530-23 <sup>(5)</sup>				
91-026 877-04	91-053 417-23 <sup>(5)</sup>				91-053 633-91

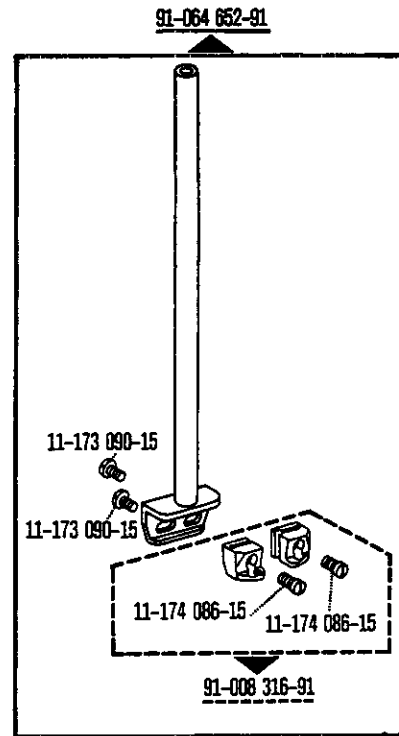
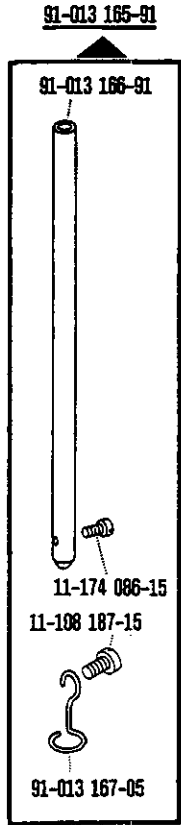

-6/21  
-34/01  
-66/01  
-275/01  
-277/01

-6/21-915/02  
-45/01-915/02  
-45/02-915/02

91-026 631-05

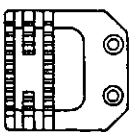

-66/01

91-026 833-04

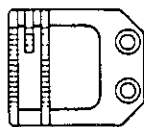

-275/01  
-277/01

91-026 883-05

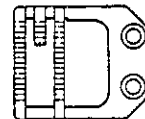

-45/01-915/02  
-45/01-915/05  
-45/02-915/02  
-45/02-915/05

91-026 884-05

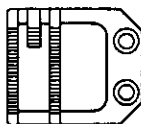

-6/21  
-6/21-915/02  
-6/21-915/05  
-45/01-915/02  
-45/01-915/05  
-45/02-915/02

91-026 891-05

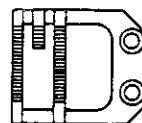

-6/21  
-6/21-915/02

91-047 401-04

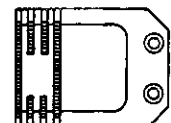

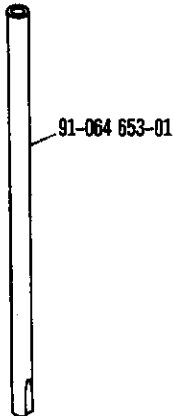

91-063 148-91

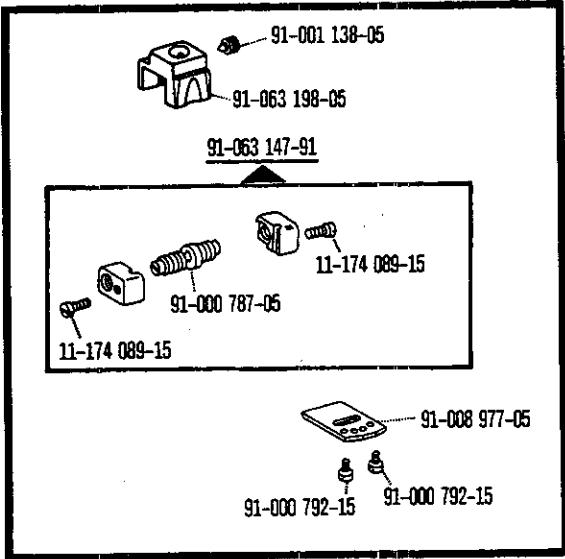

-6/21-91  
-45/01-91  
-45/02-91

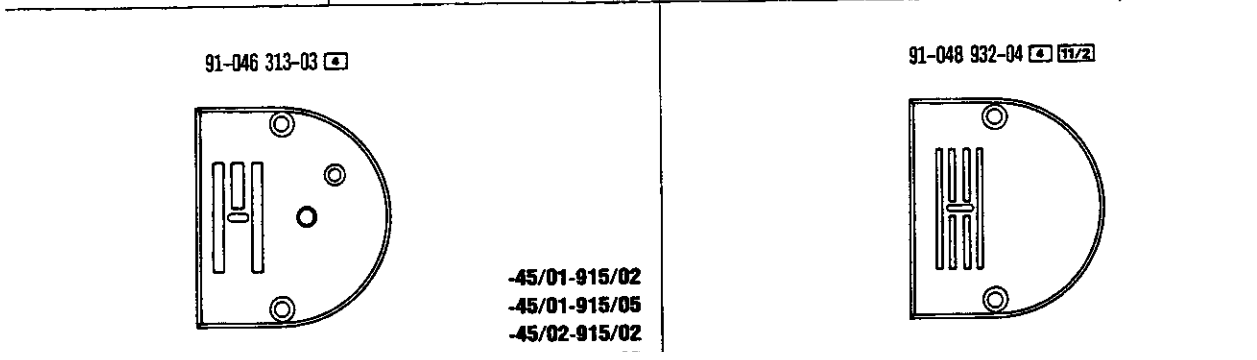
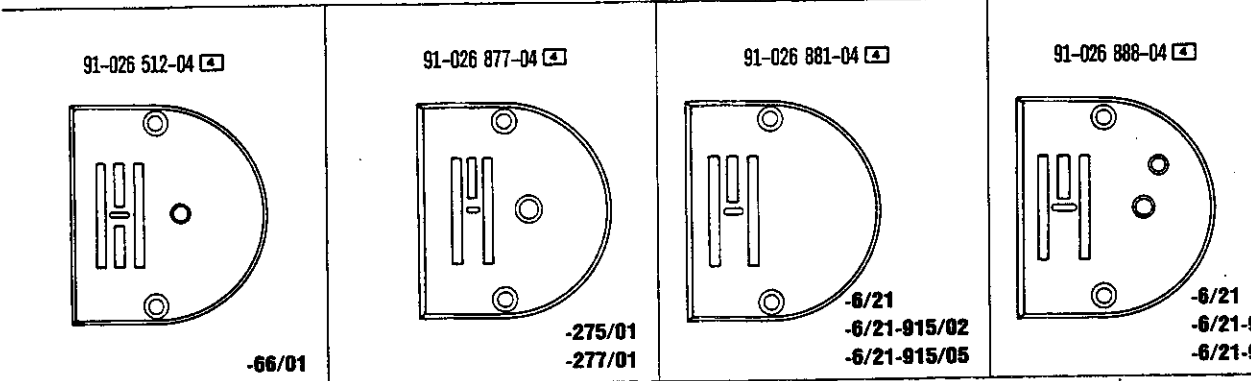

91-041 283-03 

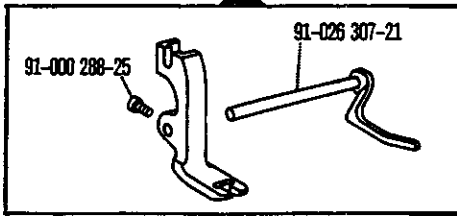

-45/01-915/02  
-45/01-915/05  
-45/02-915/02  
-45/02-915/05

91-043 522-03 



-6/21  
-6/21-915/02  
-6/21-915/05

91-051 186-93 

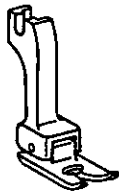

-66/01

91-051 276-04 

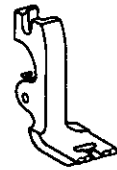

-45/01-915/02  
-45/01-915/05  
-45/02-915/02  
-45/02-915/05

91-051 280-04 



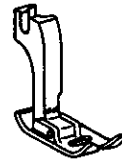

-45/01-915/02  
-45/01-915/05  
-45/02-915/02  
-45/02-915/05

91-051 998-03 



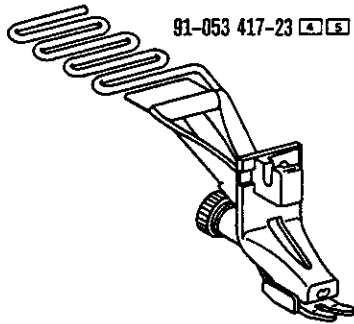

-6/21  
-6/21-915/02  
-6/21-915/05

91-053 417-23  



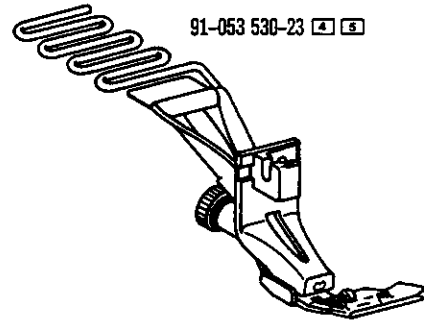

-277/01

91-053 530-23  







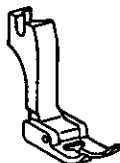

-275/01

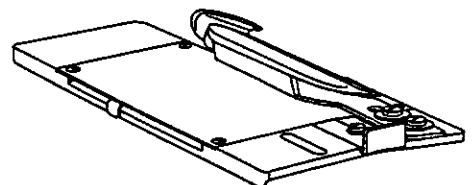
91-054 713-03  



91-040 373-23 

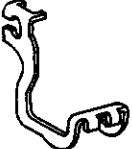
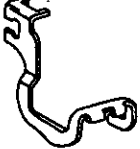

<p>91-041 842-25</p>  <p>-45/02-915/02 -45/02-915/05</p>	<p>91-041 844-25</p>  <p>-45/01-915/02 -45/01-915/05</p>	<p>91-041 845-21</p>  <p>-45/01-915/02 -45/01-915/05</p>	<p>91-042 586-21</p>  <p>-45/02-915/02 -45/02-915/05</p>
<p>91-105 996-21</p>  <p>-45/02-915/02 -45/02-915/05</p>	<p>91-105 997-21</p>  <p>-45/01-915/02 -45/01-915/05</p>	<p>91-053 749-25</p>  <p>-34/01</p>	<p>91-053 750-25</p>  <p>-6/21 -6/21-915/02 -6/21-915/05 -45/01-915/02 -45/01-915/05 -45/02-915/02 -45/02-915/05</p>

91-053 633-91

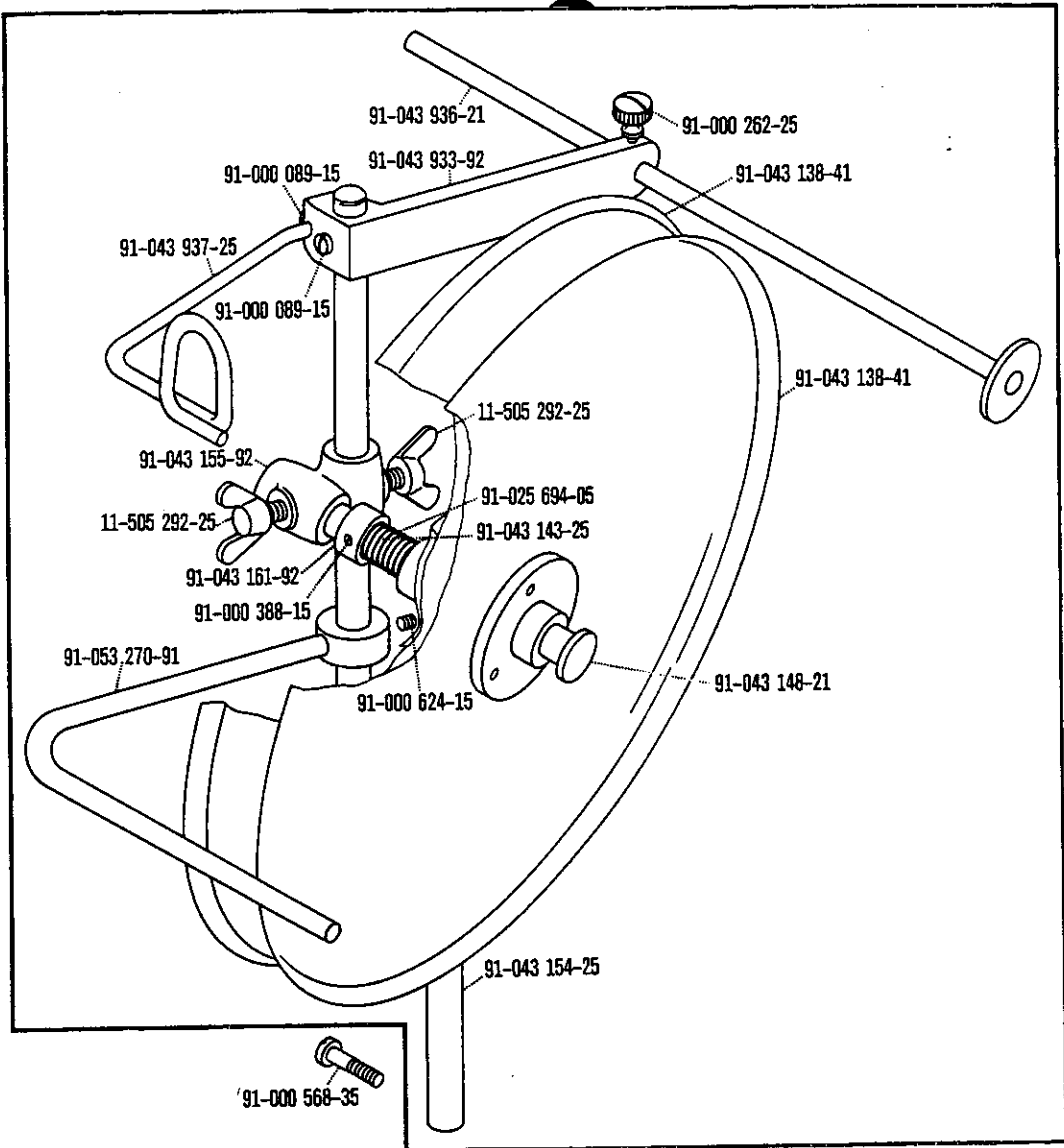

# PFAFF

**G.M. PFAFF  
Aktiengesellschaft**

Postfach 3020  
D-67653 Kaiserslautern

Königstr. 154  
D-67655 Kaiserslautern

Telefon: (0631) 200-0  
Telefax: (0631) 172 02  
Telex: 45753 PFAFF D

Gedruckt in der BRD  
Printed in Germany  
Imprimé en R.F.A.  
Impreso en la R.F.A.