

# PFAFF

## 938

Unterklassen-Ausstattung

Subclass parts

Composition des sous-classes

Composición de las subclases

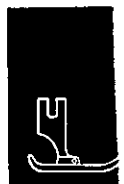


Table of subclasses  
Table des sous-classes  
Tabla de subclases

PFAFF 938

Unterklasse Subclass Sous-classe Subclase	-2/96-900/...-918/37	-3/21 (-900/..)	-3/21 (-900/..)	-6/01 (-900/..)	-6/01 (-900/..)
Arbeitsgang Operation Operation Operacion	Für rechte Kanten- näharbeiten. For right-edge sewing. Pour piqûre en bordure à droite. Para costuras marginales a la derecha.	Für linke Kantennäharbeiten. Standardform des Teile- satzes. Spezialfuß mit abge- setzter Sohle (Anschlag links). For left-edge sewing. Standard part set. Special foot with relieved shoe (edge guide at the left). Pour piqûre en bordure à gauche. Jeu de pièces standard. Pied spécial à semelle étagée (butée à gauche). Para costura marginales a la izquierda. Juego de piezas estándard. Pie especial con plantilla escalonada (guía a la izquierda).	Für linke Kantennäharbeiten. Standardform des Teile- satzes. Spezialfuß mit abge- setzter Sohle (Anschlag links). For left-edge sewing. Standard part set. Special foot with relieved shoe (edge guide at the left). Pour piqûre en bordure à gauche. Jeu de pièces standard. Pied spécial à semelle étagée (butée à gauche). Para costura marginales a la izquierda. Juego de piezas estándard. Pie especial con plantilla escalonada (guía a la izquierda).	Für allgemeine Näharbeiten. Standardform des Teile- satzes. For ordinary sewing operations. Standard part set. Travaux d'utilité courante. Jeu de pièces standard. Para trabajos de costura en general. Juego de piezas estándar.	Für allgemeine Näharbeiten. Standardform des Teile- satzes. For ordinary sewing operations. Standard part set. Travaux d'utilité courante. Jeu de pièces standard. Para trabajos de costura en general. Juego de piezas estándar.
Ausführung Model Version Tipo de maquina	B	AN 2.5; BN 2.5	AN 2.5; BN 2.5	AN 2.5; BN 2.5	AN 2.5; BN 2.5
Nadelabstand in mm Needle gauge in mm Ecartement des aiguilles en mm Distancia entre agujas en mm					
Saumbreite in mm Hem width in mm Largeur de l'ourlet en mm Anchura del dobladillo en mm					
Überstichbreite in mm Stitch width in mm Jete de l'aiguille en mm Anchura del zigzag en mm	6.0	4.5	6.0	4.5	6.0
Nadelstange Needle bar Barre à aiguille Barra de aguja	91-168 019-91	91-168 019-91	91-168 019-91	91-168 019-91	91-168 019-91
Stoffschieber <u>4</u> Feed dog Griffe Transportador inferior		91-047 576-04	91-047 575-04	91-047 576-04	91-047 575-04
Stichplatte <u>4</u> Needle plate Plaque à aiguille Placa de aguja	99-248 862-90	91-058 114-24	91-058 113-24	91-058 114-24	91-058 113-24
Nahfuß <u>4</u> Presser foot Pied presseur Pie prensateelas	99-248 862-90	91-055 179-03	91-055 177-03	91-054 504-23	91-054 501-23
Apparat <u>5</u> Attachment Appareil Aparato					
Bandführung Tape guide Guide-ruban Guiacintas					



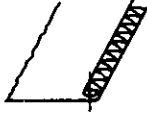
Table des sous-classes  
Tabla de subclases

PFAFF 938

Unterklasse Subclass Sous-classe Subclase	-6/01 (-900/..)	-6/01-915/05	-6/01-915/05	-6/21 (-900/..)	-6/21 (-900/..)
Arbeitsgang Operation Opération Operación	Für allgemeine Näharbeiten. Standardform des Teilesatzes. For ordinary sewing operations. Standard part set. Travaux d'utilité courante. Jeu de pièces standard. Para trabajos de costura en general. Juego de piezas estándar.	Für allgemeine Näharbeiten. Standardform des Teilesatzes. For ordinary sewing operations. Standard part set. Travaux d'utilité courante. Jeu de pièces standard. Para trabajos de costura en general. Juego de piezas estándar.	Für allgemeine Näharbeiten. Standardform des Teilesatzes. For ordinary sewing operations. Standard part set. Travaux d'utilité courante. Jeu de pièces standard. Para trabajos de costura en general. Juego de piezas estándar.	Wie -6/01; jedoch Spezialform des Teilesatzes (Außenzahnreihen durchgehend und halbe Zahnreihe hinter dem Stichloch). Same as -6/01; but with special part set. (Full-length outer tooth rows, half-length tooth rows behind needle hole). Comme la -6/01; mais avec jeu de pièces de forme spéciale. (Rangées de dents extérieures continues et demi-rangées de dents derrière le trou d'aiguille de la plaque). Como la -6/01; pero forma especial del juego de piezas. (Hileras de dientes exteriores continuas y media hilera detrás del agujero de la placa de aguja).	Wie -6/01; jedoch Spezialform des Teilesatzes (Außenzahnreihen durchgehend und halbe Zahnreihe hinter dem Stichloch). Same as -6/01; but with special part set. (Full-length outer tooth rows, half-length tooth rows behind needle hole). Comme la -6/01; mais avec jeu de pièces de forme spéciale. (Rangées de dents extérieures continues et demi-rangées de dents derrière le trou d'aiguille de la plaque). Como la -6/01; pero forma especial del juego de piezas. (Hileras de dientes exteriores continuas y media hilera detrás del agujero de la placa de aguja).
Ausführung Model Version Tipo de máquina	AN 2,5; BN 2,5	A; B	A; B	AN 2,5; BN 2,5	AN 2,5; BN 2,5
Nadelabstand in mm Needle gauge in mm Ecartement des aiguilles en mm Distancia entre agujas en mm		4,5	6,0		
Saumbreite in mm Hem width in mm Largeur de l'ourlet en mm Anchura del dobladillo en mm					
Überstichbreite in mm Stitch width in mm Jetée de l'aiguille en mm Anchura del zigzag en mm	7,0			4,5	6,0
Nadelstange Needle bar Barre à aiguille Barra de aguja	91-168 019-91	91-167 809-91	91-167 809-91	91-168 019-91	91-168 019-91
Stoffschieber <u>4</u> Feed dog Griffe Transportador inferior	91-047 575-04	91-047 570-04	91-047 678-04	91-047 691-04	91-047 703-04
Stichplatte <u>4</u> Needle plate Plaque à aiguille Placa de aguja	91-058 034-24	91-058 086-24	91-058 252-24	91-058 257-24	91-058 283-24
Nähfuß <u>4</u> Presser foot Pied presseur Pie prensatelas	91-054 501-23	91-054 504-23	91-054 501-23	91-054 504-23	91-054 501-23
Apparat <u>5</u> Attachment Appareil Aparato					
Bandführung Tape guide Guide-ruban Guiacintas					

Table des sous-classes  
 Tabla de subclases

PFAFF 938

Unterklasse Subclass Sous-classe Subclase	-17/31 (-900/..)	-17/31 (-900/..)	-19/54 (-900/..)	-34/01 (-900/..)	-34/01 (-900/..)
Arbeitsgang Operation Operation Operación				Zum Nähen feiner Materialien. Standardform des Teilesatzes. For sewing light fabrics. Standard parts set. Pour la couture de matières fines. Jeu de pièces standard. Para coser materiales finos. Juego de piezas estándar.	
Ausführung Model Version Tipo de máquina	AN 2.5; BN 2.5	AN 2.5; BN 2.5	AN 2.5	A; B	AN 2.5; BN 2.5
Nadelabstand in mm Needle gauge in mm Ecartement des aiguilles en mm Distancia entre agujas en mm					
Saumbreite in mm Hem width in mm Largeur de l'ourlet en mm Anchura del dobladillo en mm			1; 1.5; 2		
Überstichbreite in mm Stitch width in mm Jete de l'aiguille en mm Anchura del zigzag en mm	4,5	6,0	3,0	3,0	3,0
Nadelstange Needle bar Barre à aiguille Barra de aguja	91-168 019-91	91-168 019-91	91-168 019-91	91-168 019-91	91-168 019-91
Stoffschieber <sup>4</sup> Feed dog Griffe Transportador inferior	91-047 764-04	91-047 766-04	91-047 588-04	91-047 587-04	91-047 588-04
Stichplatte <sup>4</sup> Needle plate Plaque à aiguille Placa de aguja	91-058 370-24	91-058 381-24	91-058 140-24	91-058 139-04	91-058 140-24
Nähfuß <sup>4</sup> Presser foot Pied presseur Pie prensateelas	91-055 056-23	91-055 056-03	91-052 023-93	91-055 030-23	91-055 030-23
Apparat <sup>5</sup> Attachment Appareil Aparato	91-050 960-23	91-050 960-23			
Bandführung Tape guide Guide-ruban Guiacintas	91-040 392-21	91-040 392-21			
Bandrollenträger Tape reel bracket Plateau dérouleur Portarollos	91-050 966-70/895 <sup>60</sup> 91-043 943-70/895 <sup>60</sup>	91-050 966-70/895 <sup>60</sup> 91-043 943-70/895 <sup>60</sup>			

**Table des sous-classes**  
**Table des sous-classes**  
**Tabla de subclases**

**PFAFF 938**

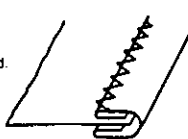
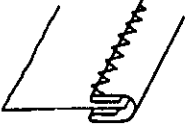
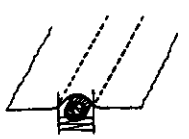
Unterklasse Subclass Sous-classe Subclase	-34/01 (-900/..)	-34/01 (-900/..)	-39/31 (-900/..)	-39/31 (-900/..)	-45/02-915/05 (-900/..)
Arbeitsgang Operation Operation Operación	Zum Nähen feiner Materialien. Standardform des Teilesatzes. For sewing light fabrics. Standard parts set. Pour la couture de matières fines. Jeu de pièces standard. Para coser materiales finos. Juego de piezas estándar.	Zum Nähen feiner Materialien. Standardform des Teilesatzes. For sewing light fabrics. Standard parts set. Pour la couture de matières fines. Jeu de pièces standard. Para coser materiales finos. Juego de piezas estándar.			
Ausführung Model Version Tipo de máquina	A; B	AN 2,5; BN 2,5	AN 2,5; BN 2,5	AN 2,5; BN 2,5	A; B
Nadelabstand in mm Needle gauge in mm Ecartement des aiguilles en mm Distancia entre agujas en mm					3,0
Saumbreite in mm Hem width in mm Largeur de l'ourlet en mm Anchura del dobladillo en mm					
Überstichbreite in mm Stitch width in mm Jetée de l'aiguille en mm Anchura del zigzag en mm	4,5	4,5	4,5	6,0	
Nadelstange Needle bar Barre à aiguille Barra de aguja	91-168 019-91	91-168 019-91	91-168 019-91	91-168 019-91	91-167 809-91
Stoffschieber <u>4</u> Feed dog Griffe Transportador inferior	91-047 666-04	91-047 653-04	91-047 764-04	91-047 766-04	91-047 570-04
Stichplatte <u>4</u> Needle plate Plaque à aiguille Placa de aguja	91-058 217-24	91-058 211-24	91-058 370-24	91-058 381-24	91-058 253-04
Stichplatteneinsatz Needle plate insert Applique de plaque Aplique de la placa de aguja					91-026 904-14 <u>21/2</u>
Nahfuß <u>4</u> Presser foot Pied presseur Pie prensatelas	91-055 112-23	91-055 112-23	91-055 056-23	91-055 056-23	91-055 099-93 <u>19</u> = 1,6 mm 91-055 148-93 <u>22</u> <u>19</u> = 2 mm
Apparat <u>5</u> Attachment Appareil Aparato			91-050 961-93	91-050 961-93	
Bandführung Tape guide Guide-ruban Guiacintas					
Bandrollenträger Tape reel bracket Plateau dérouleur Portarollos			91-050 966-70/895	91-050 966-70/895	

TABLE OF SUBCLASSES  
Table des sous-classes  
Tabla de subclases PFAFF 938

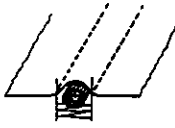
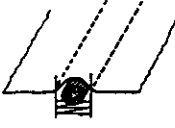



Unterklasse Subclass Sous-classe Subclase	-45/02-915/05 (-900/..)	-45/02-915/05 (-900/..)	-49/01 (-900/..)	-358/01-918/.. (-900/..)	-716/04-6/01 (-900/..)
Arbeitsgang Operation Operation Operacion					
Ausführung Model Version Tipo de máquina	A; B	A; B	A; B	A; B	AN 2.5; BN 2.5
Nadelabstand in mm Needle gauge in mm Ecartement des aiguilles en mm Distancia entre agujas en mm	4.5	6.0			
Saumbreite in mm Hem width in mm Largeur de fourlet en mm Anchura del dobladillo en mm					
Überstichbreite in mm Stitch width in mm Jetée de l'aiguille en mm Anchura del zigzag en mm			6.0	2.0	6.0
Nadelstange Needle bar Barre à aiguille Barra de aguja	91-167 809-91	91-167 809-91	91-168 019-91	91-168 019-91	91-168 019-91
Stoffschieber <u>4</u> Feed dog Griffe Transportador inferior	91-047 570-04	91-047 678-04	91-047 632-04	91-047 719-04	91-047 575-04
Stichplatte <u>4</u> Needle plate Plaque à aiguille Placa de aguja	91-047 253-04	91-058 254-04	91-058 199-04	91-058 298-04	91-058 113-24
Stichplatteneinsatz Needle plate insert Applique de plaque Apliche de la placa de aguja	91-026 904-14 <u>21;2</u>	91-026 904-14 <u>21;2</u>	91-158 185-15		
Nähfuß <u>4</u> Presser foot Pied presseur Pie prensateelas	91-055 147-93 <u>19</u> = 2 mm 91-055 098-93 <u>22</u> <u>19</u> = 2,4 mm 91-055 150-93 <u>22</u> <u>19</u> = 2,8 mm	91-055 149-93 <u>19</u> = 2,8 mm 91-055 096-93 <u>19</u> = 4 mm	91-055 151-03	91-057 112-93	91-054 501-23
Apparat <u>5</u> Attachment Appareil Aparato				91-168 430-21	
Bandführung Tape guide Guide-ruban Guiacintas					
Lineal Edge guide Guide-bord Guia recta					

Table of subclasses  
 Table des sous-classes  
 Tabla de subclases PFAFF 938




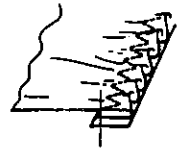
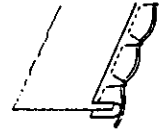
Unterklasse Subclass Sous-classe Subclase	-716/06-6/01 (-900/..)	-716/06-6/01 (-900/..)	-716/06-82/12 (-900/..)	-716/06-83/03 (-900/..)	-716/08-17/82 (-900/..)
Arbeitsgang Operation Opération Operación					
Ausführung Model Version Tipo de máquina	AN 2.5; BN 2.5	AN 2.5; BN 2.5	AN 2.5; BN 2.5	AN 2.5; BN 2.5	AN 2.5
Nadelabstand in mm Needle gauge in mm Écartement des aiguilles en mm Distancia entre agujas en mm					
Saumbreite in mm Hem width in mm Largeur de fourlet en mm Anchura del dobladillo en mm					
Überstichbreite in mm Stitch width in mm Jetée de l'aiguille en mm Anchura del zigzag en mm	6,0	7,0	7,0	7,0	6,0
Nadelstange Needle bar Barre à aiguille Barra de aguja	91-168 019-91	91-168 019-91	91-168 019-91	91-168 019-91	91-168 019-91
Stoffschieber <u>4</u> Feed dog Griffe Transportador inferior	91-047 575-04	91-059 777-04	91-059 777-04 <u>60</u> 91-059 778-04 <u>60</u>	91-059 778-04	91-047 868-04
Stichplatte <u>4</u> Needle plate Plaque à aiguille Placa de aguja	91-058 113-24	91-150 028-04	91-150 028-04	91-150 028-04	91-058 580-24
Nähfuß <u>4</u> Presser foot Pied presseur Pie prensateelas	91-054 501-23	91-055 106-23	91-154 474-93 <u>60</u> 91-055 550-93 <u>60</u>	91-155 544-93	91-055 965-93
Apparat <u>5</u> Attachment Appareil Aparato			91-050 716-93 <u>60/3</u> 91-156 676-93 <u>60/4</u>	91-156 489-93	91-056 106-23
Bandführung Tape guide Guide-ruban Guiacintas				91-156 267-91	
Träger Bracket Support Soporte			91-156 634-90	91-753 936-90	91-056 109-25 91-056 116-90
Anschlag links Stop left Butée gauche Tope izquierdo			91-154 398-05		
Anschlag rechts Stop right Butée droite Tope derecho			91-154 399-05		
Bandrollenträger Tape reel bracket Plateau dérouleur Portarollos				91-156 005-71/895	91-043 943-70/895
Bandtrommel Tape reel Tambour-dérouleur Tambor-portacintas				91-156 255-71/895	
Bandtrommelträger Tape reel bracket Support de tambour Portatambor			91-056 758-70/895		

Table of subclasses  
Table des sous-classes  
Tabla de subclases PFAFF 938

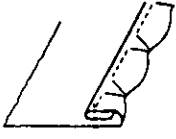
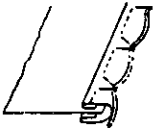
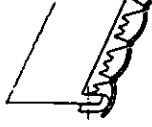
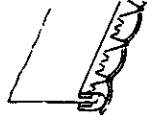


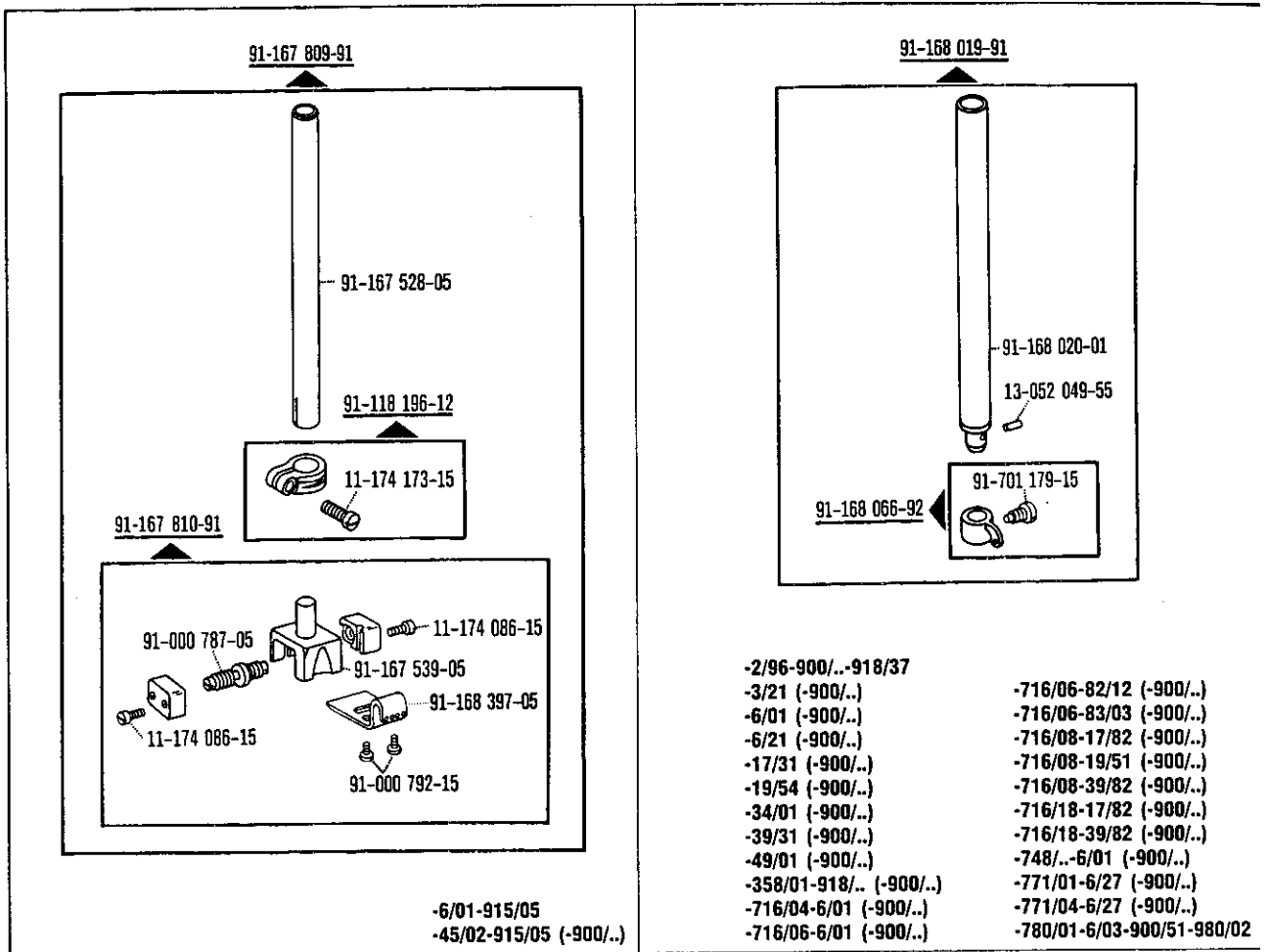
Unterklasse Subclass Sous-classe Subclase	-716/08-19/51 (-900/..)	-716/08-39/82 (-900/..)	-716/18-17/82 (-900/..)	-716/18-39/82 (-900/..)	-748/..-6/01 (-900/..)
Arbeitsgang Operation Opération Operación					Für allgemeine Näharbeiten mittels Standardteilsatz. Die Maschine ist mit Walzen-transport-Einrichtung ausgestattet. For general sewing operations with standard part set. The machine is equipped with puller feed. Pour les coutures d'utilité courante par jeu de pièces standard. La machine est équipée d'un puller. Para trabajos de costura en general mediante juego de piezas estándar. La máquina va equipada con un puller.
Ausführung Model Version Tipo de máquina	AN 2,5; BN 2,5	AN 2,5	AN 2,5	AN 2,5	AN 2,5; BN 2,5
Nadelabstand in mm Needle gauge in mm Ecartement des aiguilles en mm Distancia entre agujas en mm					
Saumbreite in mm Hem width in mm Largeur de l'ourlet en mm Anchura del dobladillo en mm					
Überstichbreite in mm Stitch width in mm Jetée de l'aiguille en mm Anchura del zigzag en mm	6,0	6,0	6,0	6,0	6,0
Nadelstange Needle bar Barre à aiguille Barra de aguja	91-168 019-91	91-168 019-91	91-168 019-91	91-168 019-91	91-168 019-91
Stoffschieber <sup>4</sup> Feed dog Griffe Transportador inferior	91-047 868-04	91-047 868-04	91-047 868-04	91-047 868-04	91-047 575-04
Stichplatte <sup>4</sup> Needle plate Plaque à aiguille Placa de aguja	91-058 580-24	91-058 580-24	91-058 580-24	91-058 580-24	91-058 113-24
Nähfuß <sup>4</sup> Presser foot Pied presseur Pie prensatelas	91-052 021-93 <sup>5</sup>	91-055 965-93	91-055 965-93	91-055 965-93	91-155 342-03
Apparat <sup>5</sup> Attachment Appareil Aparato		91-056 075-23	91-056 106-23	91-056 075-23	
Bandführung Tape guide Guide-ruban Guiacintas					
Träger Bracket Support Soporte		91-056 109-25 91-056 116-90	91-056 109-25 91-056 116-90	91-056 109-25 91-056 116-90	
Bandrollenträger Tape reel bracket Plateau dérouleur Portarollos		91-043 943-70/895	91-043 943-70/895	91-043 943-70/895	

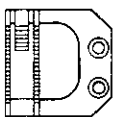
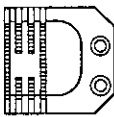
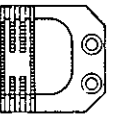
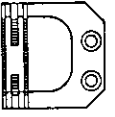
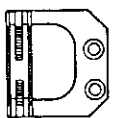
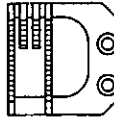
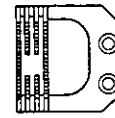
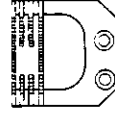


Table of subclasses  
Table des sous-classes  
Tabla de subclases


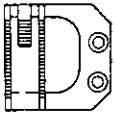

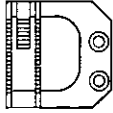

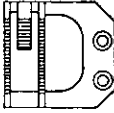

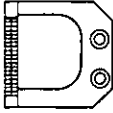

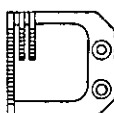

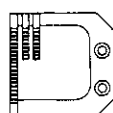

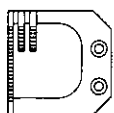

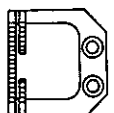

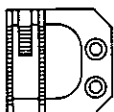

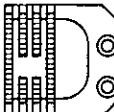

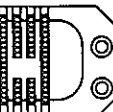

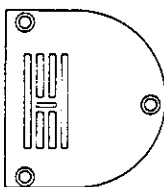


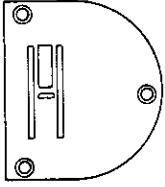

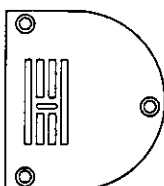


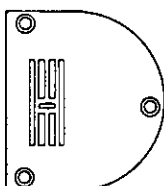

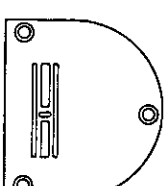

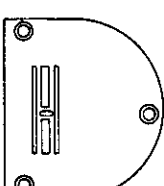
PFAFF 938

Unterklasse Subclass Sous-classe Subclase	-771/01-6/27 (-900/..)	-771/04-6/27 (-900/..)	-780/01-6/03 -900/51-980/02
Arbeitsgang Operation Opération Operación			Wie -6/01: mit 2-teiligem Fuß Sensorenabstand zur Nadelmitte 10 mm. Same as -6/01: but with two-part foot. Clearance between sensor and needle centre 10 mm. Comme la -6/01: mais avec pied en deux parties. Ecartement détecteur-axe de l'aiguille 10 mm. Como la -6/01: pero con pie bipartido. Distancia del sensor al centro de la aguja 10 mm.
Ausführung Model Version Tipo de máquina	AN 2,5	AN 2,5	AN 2.5; BN 2.5
Nadelabstand in mm Needle gauge in mm Ecartement des aiguilles en mm Distancia entre agujas en mm			
Saumbreite in mm Hem width in mm Largeur de fourlet en mm Anchura del dobladillo en mm			
Überstichbreite in mm Stitch width in mm Jetée de l'aiguille en mm Anchura del zigzag en mm	3,0 9 = 1,5 mm	3,0 9 = 1,5 mm	4,5
Nadelstange Needle bar Barre à aiguille Barra de aguja	91-168 019-91	91-168 019-91	91-168 019-91
Stoffschieber 4 Feed dog Griffe Transportador inferior	91-059 294-04	91-059 294-04	91-059 349-04
Stichplatte 4 Needle plate Plaque à aiguille Placa de aguja	91-150 168-93	91-150 168-93	91-158 647-93
Nahfuß 4 Presser foot Pied presseur Pie prensatelas	91-155 138-01	91-155 138-01	91-155 247-93
Apparat 5 Attachment Appareil Aparato			
Bandführung Tape guide Guide-ruban Guiacintas			
Träger Bracket Support Soporte			
Messer Knife Couteau Cuchilla	91-167 973-05 [28] 91-167 350-01	91-167 973-05 [28] 91-167 350-01	
Niederhalter Work retainer Pied de maintien Pie de retención			91-155 367-91

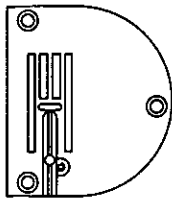
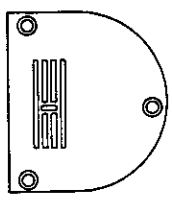
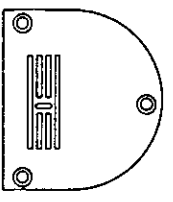
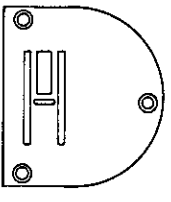
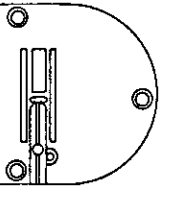
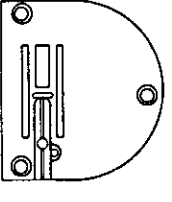
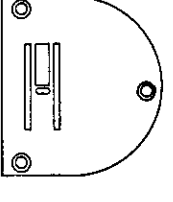
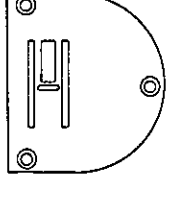
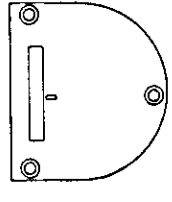
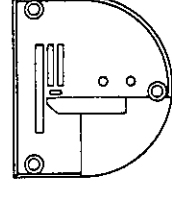
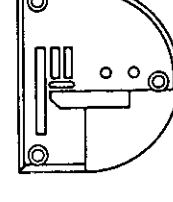
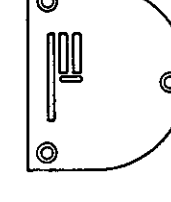
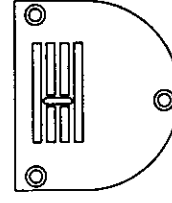
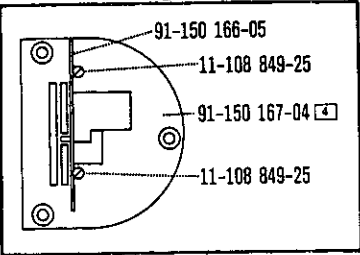
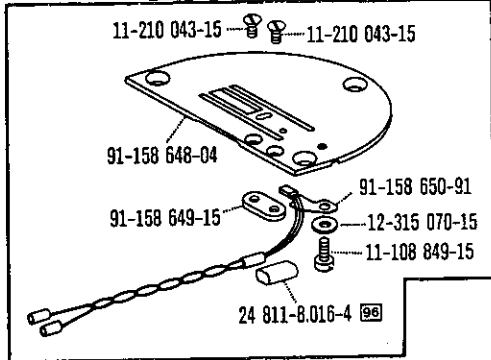


<p>91-047 570-04 </p>  <p>-6/01-915/05          -45/02-915/05 (-900/..)</p>	<p>91-047 575-04 </p>  <p>-3/21 (-900/..)          -6/01 (-900/..)          -716/04-6/01 (-900/..)          -716/06-6/01 (-900/..)          -748/..-6/01 (-900/..)</p>	<p>91-047 576-04 </p>  <p>-3/21 (-900/..)          -6/01 (-900/..)</p>	<p>91-047 587-04 </p>  <p>-34/01 (-900/..)</p>
<p>91-047 588-04 </p>  <p>-19/54 (-900/..)          -34/01 (-900/..)</p>	<p>91-047 632-04 </p>  <p>-49/01 (-900/..)</p>	<p>91-047 653-04 </p>  <p>-34/01 (-900/..)</p>	<p>91-047 666-04 </p>  <p>-34/01 (-900/..)</p>

Gauge parts  
 Organes de couture  
 Organos de costura PFAFF 938

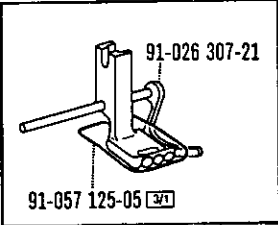
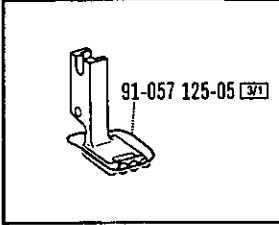
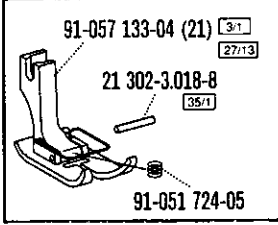
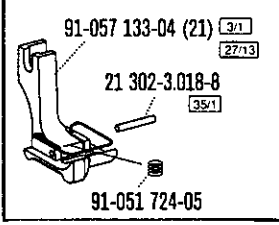
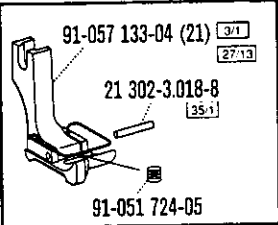
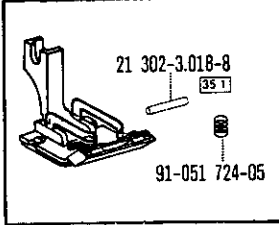
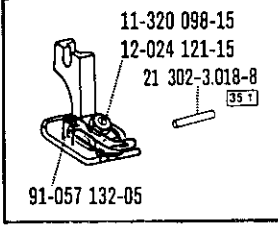
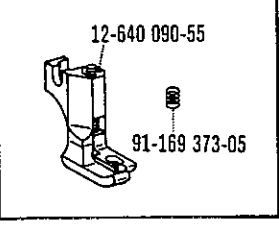
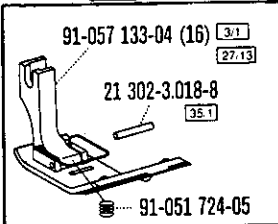
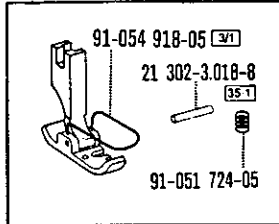
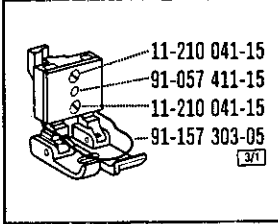
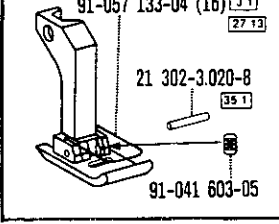
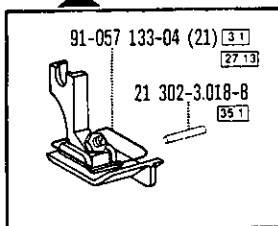
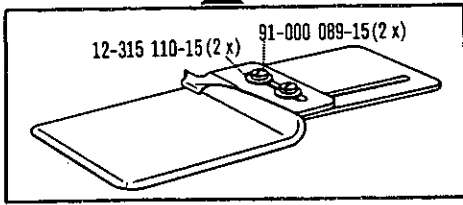
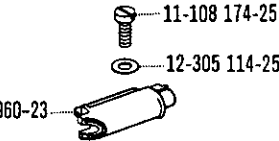
<p>91-047 678-04 </p>  <p>-6/01-915/05 -45/02-915/05 (-900/..)</p>	<p>91-047 691-04 </p>  <p>-6/21 (-900/..)</p>	<p>91-047 703-04 </p>  <p>-6/21 (-900/..)</p>	<p>91-047 719-04 </p>  <p>-358/01-918/.. (-900/..)</p>	
<p>91-047 764-04 </p>  <p>-17/31 (-900/..) -39/31 (-900/..)</p>	<p>91-047 766-04 </p>  <p>-17/31 (-900/..) -39/31 (-900/..)</p>	<p>91-047 868-04 </p>  <p>-716/08-17/82 (-900/..) -716/08-19/51 (-900/..) -716/08-39/82 (-900/..) -716/18-17/82 (-900/..) -716/18-39/82 (-900/..)</p>	<p>91-059 294-04 </p>  <p>-771/01-6/27 (-900/..) -771/04-6/27 (-900/..)</p>	
<p>91-059 349-04 </p>  <p>-780/01-6/03-900/51-980/02</p>	<p>91-059 777-04 </p>  <p>-716/06-6/01 (-900/..) -716/06-82/12 (-900/..)</p>	<p>91-059 778-04 </p>  <p>-716/06-82/12 (-900/..) -716/06-83/03 (-900/..)</p>	<p>91-058 034-24 </p>  <p>-6/01 (-900/..)</p>	<p>91-058 086-44  </p>  <p>-6/01-915/05</p>
<p>91-058 113-24 </p>  <p>-3/21 (-900/..) -6/01 (-900/..) -716/04-6/01 (-900/..) -716/06-6/01 (-900/..) -748/..-6/01 (-900/..)</p>	<p>91-058 114-24  </p>  <p>-3/21 (-900/..) -6/01 (-900/..)</p>	<p>91-058 139-24 </p>  <p>-34/01 (-900/..)</p>	<p>91-058 140-24 </p>  <p>-19/54 (-900/..) -34/01 (-900/..)</p>	

Gauge parts  
 Organes de couture  
 Organos de costura PFAFF 938

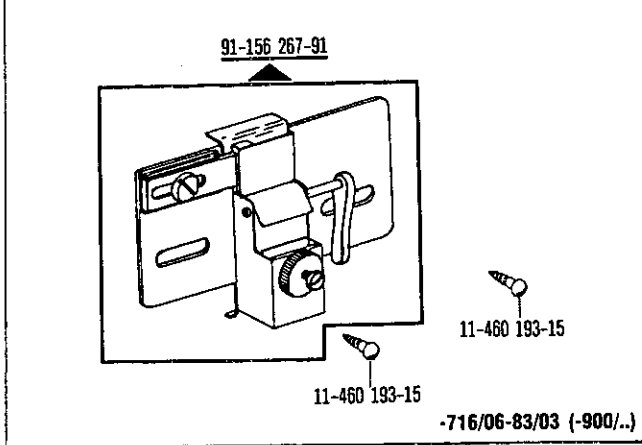
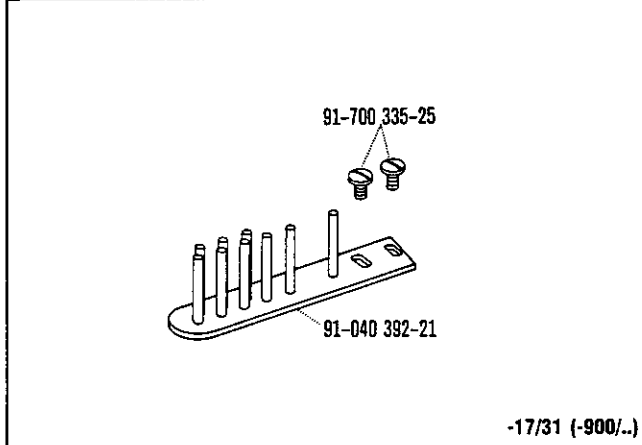
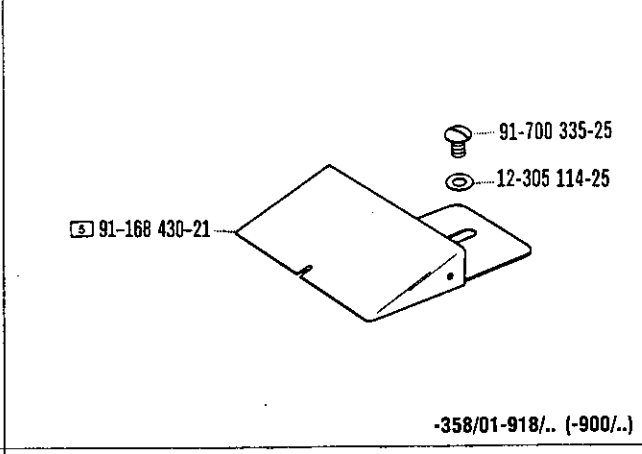
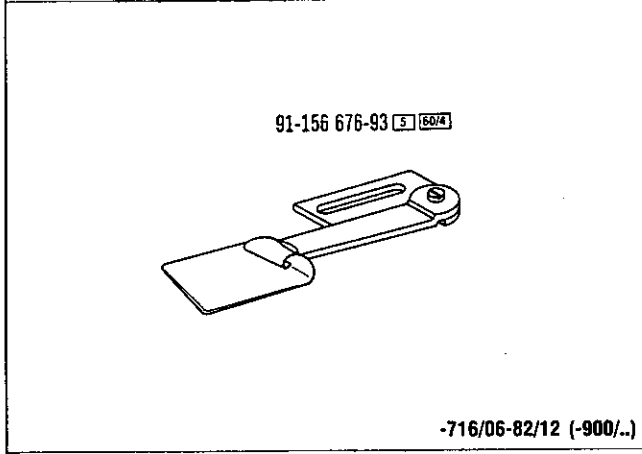
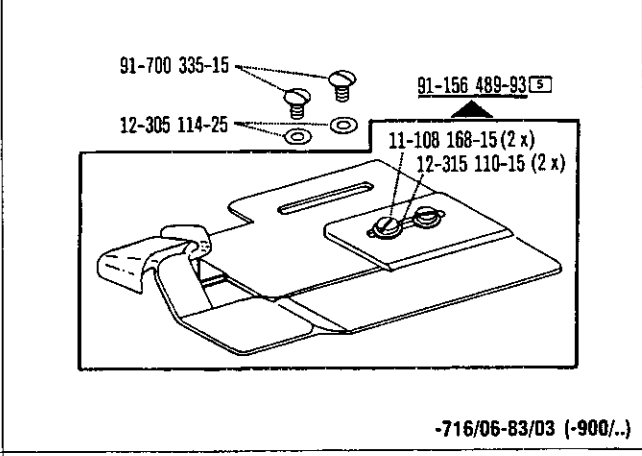
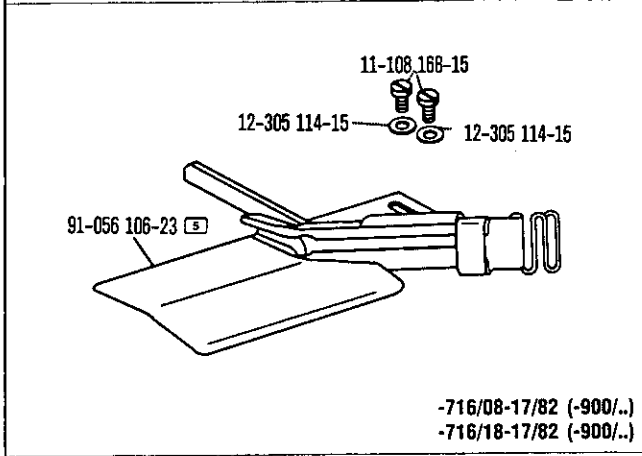
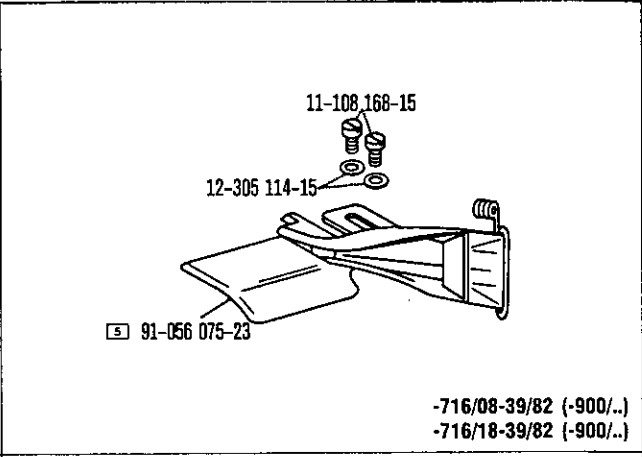
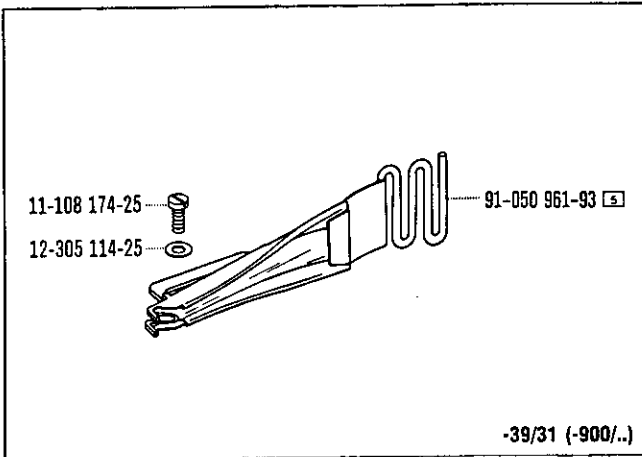
<p>91-058 199-04 <span style="border: 1px solid black; padding: 0 2px;">4</span></p>  <p>-49/01 (-900/..)</p>	<p>91-058 211-24 <span style="border: 1px solid black; padding: 0 2px;">4</span></p>  <p>-34/01 (-900/..)</p>	<p>91-058 217-24 <span style="border: 1px solid black; padding: 0 2px;">4</span></p>  <p>-34/01 (-900/..)</p>	<p>91-058 252-24 <span style="border: 1px solid black; padding: 0 2px;">4</span></p>  <p>-6/01-915/05</p>
<p>91-058 253-24 <span style="border: 1px solid black; padding: 0 2px;">4</span> <span style="border: 1px solid black; padding: 0 2px;">10/2</span></p>  <p>-45/02-915/05 (-900/..)</p>	<p>91-058 254-24 <span style="border: 1px solid black; padding: 0 2px;">4</span></p>  <p>-45/02-915/05 (-900/..)</p>	<p>91-058 257-24 <span style="border: 1px solid black; padding: 0 2px;">4</span> <span style="border: 1px solid black; padding: 0 2px;">11/2</span></p>  <p>-6/21 (-900/..)</p>	<p>91-058 283-24 <span style="border: 1px solid black; padding: 0 2px;">4</span></p>  <p>-6/21 (-900/..)</p>
<p>91-058 298-24 <span style="border: 1px solid black; padding: 0 2px;">4</span></p>  <p>-358/01-918/.. (-900/..)</p>	<p>91-058 370-24 <span style="border: 1px solid black; padding: 0 2px;">4</span> <span style="border: 1px solid black; padding: 0 2px;">11/2</span></p>  <p>-17/31 (-900/..) -39/31 (-900/..)</p>	<p>91-058 381-24 <span style="border: 1px solid black; padding: 0 2px;">4</span></p>  <p>-17/31 (-900/..) -39/31 (-900/..)</p>	<p>91-058 580-24 <span style="border: 1px solid black; padding: 0 2px;">4</span></p>  <p>-716/08-17/82 (-900/..) -716/08-19/51 (-900/..) -716/08-39/82 (-900/..) -716/18-17/82 (-900/..) -716/18-39/82 (-900/..)</p>
<p>91-150 028-04 <span style="border: 1px solid black; padding: 0 2px;">4</span></p>  <p>-716/06-6/01 (-900/..) -716/06-82/12 (-900/..) -716/06-83/03 (-900/..)</p>	<p>91-150 168-93 <span style="border: 1px solid black; padding: 0 2px;">4</span></p>  <p>91-150 166-05 11-108 849-25 91-150 167-04 <span style="border: 1px solid black; padding: 0 2px;">4</span> 11-108 849-25</p> <p>-771/01-6/27 (-900/..) -771/04-6/27 (-900/..)</p>		<p>91-158 647-93 <span style="border: 1px solid black; padding: 0 2px;">4</span> <span style="border: 1px solid black; padding: 0 2px;">11/2</span></p>  <p>11-210 043-15 11-210 043-15 91-158 648-04 91-158 649-15 91-158 650-91 12-315 070-15 11-108 849-15 24 811-8.016-4 <span style="border: 1px solid black; padding: 0 2px;">98</span></p> <p>-780/01-6/03-900/51-980/02</p>

<p>99-248 862-90</p> <p>-2/96-900/..-918/37</p>	<p>91-026 904-14 [27/2]</p> <p>91-100 265-15</p> <p>-45/02-915/05 (-900/..)</p>	<p>91-158 185-15</p> <p>91-100 265-15</p> <p>-49/01 (-900/..)</p>	<p>91-052 021-93 [4] [5]</p> <p>91-057 131-05 [37]</p> <p>-716/08-19/51 (-900/..)</p>
<p>91-052 023-93 [4] [5]</p> <p>91-057 131-05 [37]</p> <p>-19/54 (-900/..)</p>	<p>91-054 501-23 [4]</p> <p>91-057 133-04 (21) [37] [27/13]</p> <p>21 302-3.020-8 [35/1]</p> <p>91-041 603-05</p> <p>-6/01-915/05          -6/21 (-900/..)          -716/04-6/01 (-900/..)          -716/06-6/01 (-900/..)</p>	<p>91-054 504-23 [4]</p> <p>91-057 133-04 (21) [37] [27/13]</p> <p>21 302-3.018-8 [35/1]</p> <p>91-051 724-05</p> <p>-6/01 (-900/..)          -6/01-915/05          -6/21 (-900/..)</p>	<p>91-055 030-23 [4]</p> <p>91-057 133-04 (16) [37] [27/13]</p> <p>21 302-3.018-8 [35/1]</p> <p>91-051 724-05</p> <p>-34/01 (-900/..)</p>
<p>91-055 056-23 [4] [11/2]</p> <p>91-057 133-04 (16) [37] [27/13]</p> <p>91-051 725-05</p> <p>91-051 724-05</p> <p>-17/31 (-900/..)          -39/31 (-900/..)</p>	<p>91-055 096-93 [4]          [19] = 4 mm</p> <p>91-057 125-05 [37]</p> <p>-45/02-915/05 (-900/..)</p>	<p>91-055 098-93 [4]          [19] = 2,4 mm</p> <p>91-057 125-05 [37]</p> <p>-45/02-915/05 (-900/..)</p>	<p>91-055 099-93 [4]          [19] = 1,6 mm</p> <p>91-026 307-21</p> <p>91-057 125-05 [37]</p> <p>-45/02-915/05 (-900/..)</p>
<p>91-055 106-23 [4] [11/2]</p> <p>91-057 133-04 (21) [37] [27/13]</p> <p>21 302-3.018-8 [35/1]</p> <p>91-051 724-05</p> <p>-716/06-6/01 (-900/..)</p>	<p>91-055 112-23 [4]</p> <p>91-057 133-04 (21) [37] [27/13]</p> <p>21 302-3.018-8 [35/1]</p> <p>91-051 724-05</p> <p>-34/01 (-900/..)</p>	<p>91-055 147-93 [4]          [19] = 2 mm</p> <p>91-026 307-21 [27/13]</p> <p>91-057 125-05 [37]</p> <p>-45/02-915/05 (-900/..)</p>	<p>91-055 148-93 [4]          [19] = 2 mm</p> <p>91-057 125-05 [37]</p> <p>-45/02-915/05 (-900/..)</p>

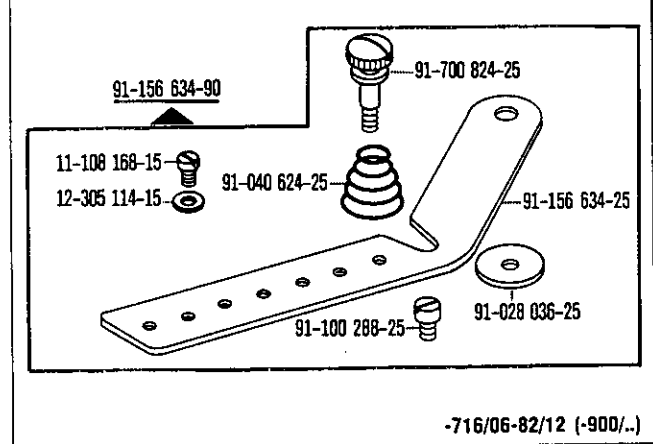
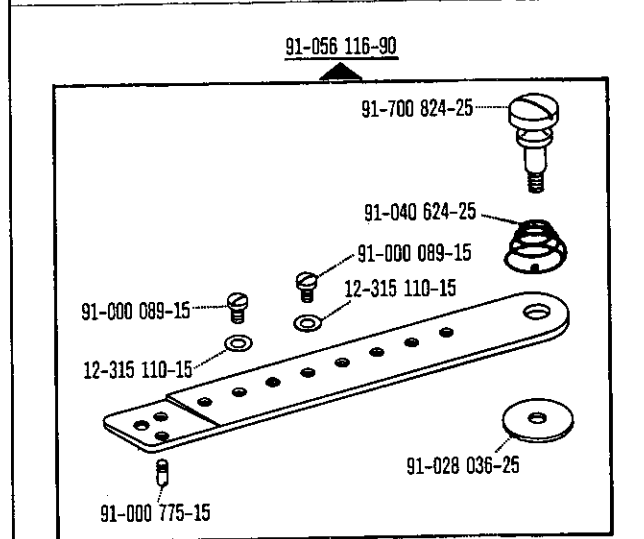
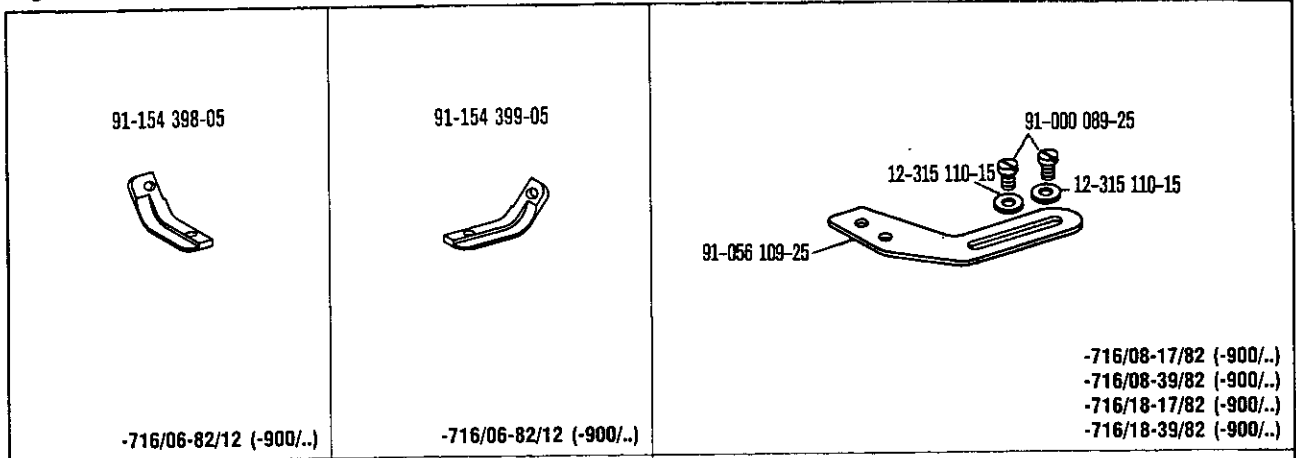
Gauge parts  
 Organes de couture  
 Organos de costura PFAFF 938

<p>91-055 149-93 <sup>4</sup>  <sub>19</sub> = 2,8 mm</p>  <p>91-057 125-05 <sup>3/1</sup></p> <p>-45/02-915/05 (-900/..)</p>	<p>91-055 150-93 <sup>4</sup>  <sub>19</sub> = 2,8 mm</p>  <p>91-057 125-05 <sup>3/1</sup></p> <p>-45/02-915/05 (-900/..)</p>	<p>91-055 151-03 <sup>4</sup></p>  <p>91-057 133-04 (21) <sup>3/1</sup>  <sub>27/13</sub></p> <p>21 302-3.018-8 <sup>35/1</sup></p> <p>91-051 724-05</p> <p>-49/01 (-900/..)</p>	<p>91-055 177-03 <sup>4</sup></p>  <p>91-057 133-04 (21) <sup>3/1</sup>  <sub>27/13</sub></p> <p>21 302-3.018-8 <sup>35/1</sup></p> <p>91-051 724-05</p> <p>-3/21 (-900/..)</p>
<p>91-055 179-03 <sup>4</sup></p>  <p>91-057 133-04 (21) <sup>3/1</sup>  <sub>27/13</sub></p> <p>21 302-3.018-8 <sup>35/1</sup></p> <p>91-051 724-05</p> <p>-3/21 (-900/..)</p>	<p>91-055 550-93 <sup>4</sup></p>  <p>21 302-3.018-8 <sup>35/1</sup></p> <p>91-051 724-05</p> <p>-716/06-82/12 (-900/..)</p>	<p>91-055 965-93 <sup>4</sup></p>  <p>11-320 098-15      12-024 121-15      21 302-3.018-8 <sup>35/1</sup></p> <p>91-057 132-05</p> <p>-716/08-17/82 (-900/..)          -716/08-39/82 (-900/..)          -716/18-17/82 (-900/..)          -716/18-39/82 (-900/..)</p>	<p>91-057 112-93 <sup>4</sup></p>  <p>12-640 090-55      91-169 373-05</p> <p>-358/01-918/.. (-900/..)</p>
<p>91-154 474-93 <sup>4</sup></p>  <p>91-057 133-04 (16) <sup>3/1</sup>  <sub>27/13</sub></p> <p>21 302-3.018-8 <sup>35/1</sup></p> <p>91-051 724-05</p> <p>-716/06-82/12 (-900/..)</p>	<p>91-155 138-01</p>  <p>91-054 918-05 <sup>3/1</sup></p> <p>21 302-3.018-8 <sup>35/1</sup></p> <p>91-051 724-05</p> <p>-771/01-6/27 (-900/..)          -771/04-6/27 (-900/..)</p>	<p>91-155 247-93 <sup>11/2</sup></p>  <p>11-210 041-15      91-057 411-15      11-210 041-15      91-157 303-05 <sup>3/1</sup></p> <p>91-051 724-05</p> <p>-780/01-6/03-900/51-980/02</p>	<p>91-155 342-03 <sup>4</sup></p>  <p>91-057 133-04 (16) <sup>3/1</sup>  <sub>27/13</sub></p> <p>21 302-3.020-8 <sup>35/1</sup></p> <p>91-041 603-05</p> <p>-748/..-6/01 (-900/..)</p>
<p>91-155 544-93 <sup>4</sup> <sup>11/2</sup></p>  <p>91-057 133-04 (21) <sup>3/1</sup>  <sub>27/13</sub></p> <p>21 302-3.018-8 <sup>35/1</sup></p> <p>91-051 724-05</p> <p>-716/06-83/03 (-900/..)</p>	<p>91-050 716-93 <sup>5</sup> <sup>60/2</sup></p>  <p>12-315 110-15 (2 x)      91-000 089-15 (2 x)</p> <p>-716/06-82/12 (-900/..)</p>		 <p>11-108 174-25      12-305 114-25      91-050 960-23</p> <p>-17/31 (-900/..)</p>

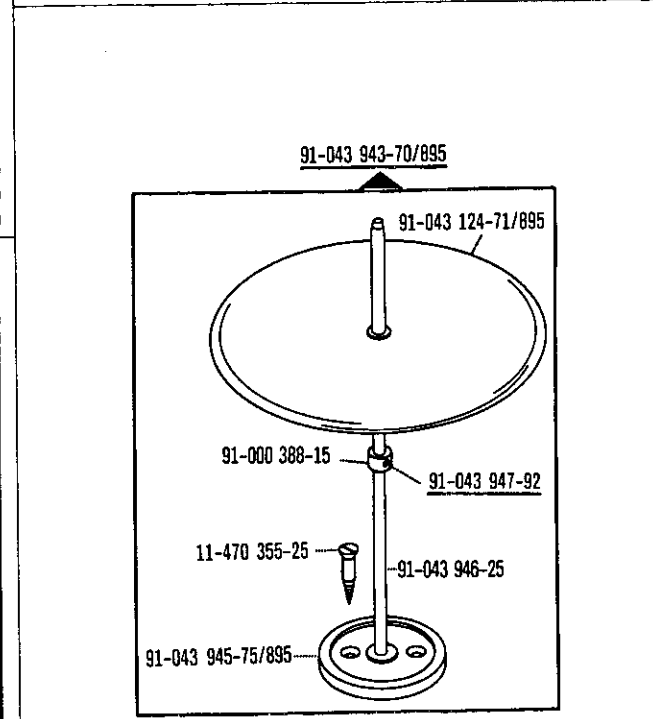
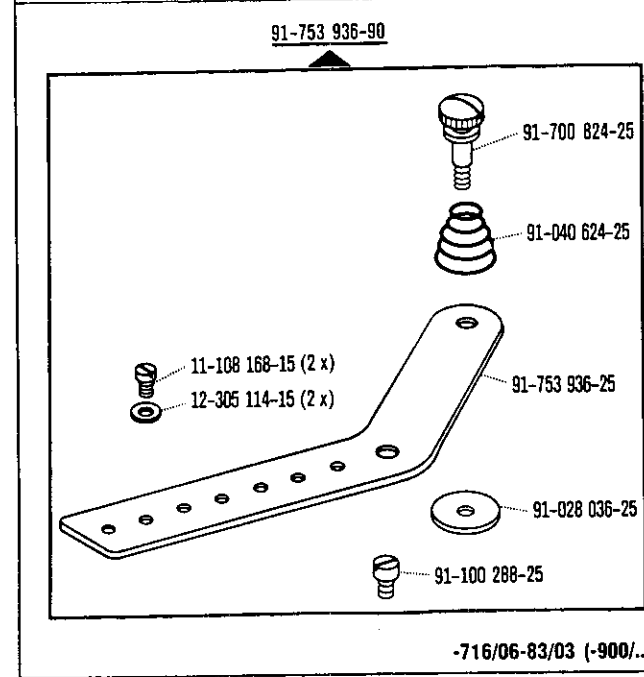
Gauge parts  
 Organes de couture  
 Organos de costura PFAFF 938



☐ siehe Erläuterungen Register A-99  
 see explanations in section A-99  
 voir légende registre A-99



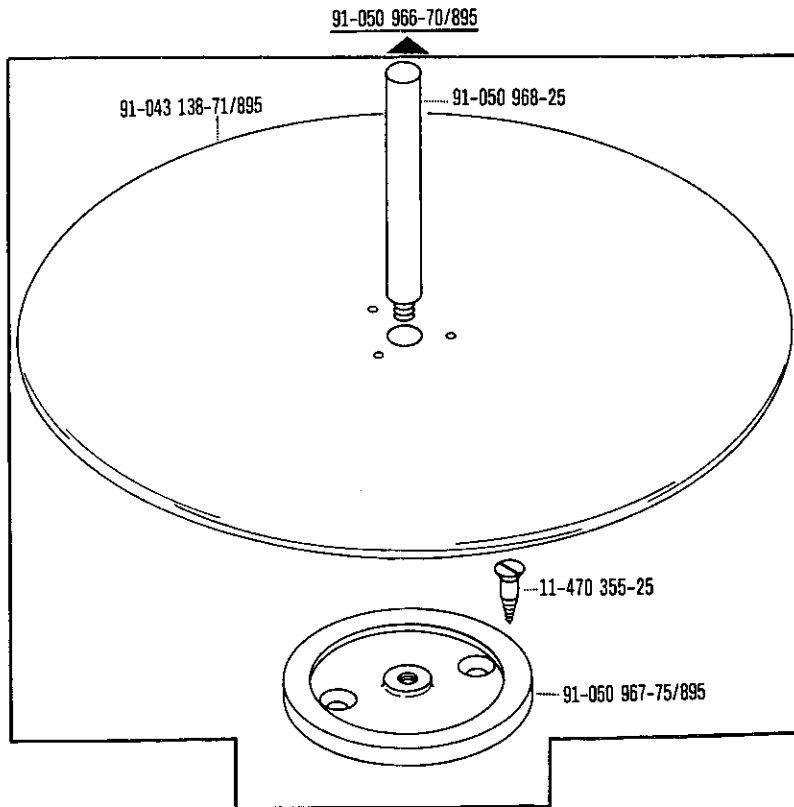
-716/08-17/82 (-900/..)  
 -716/08-39/82 (-900/..)  
 -716/18-17/82 (-900/..)  
 -716/18-39/82 (-900/..)



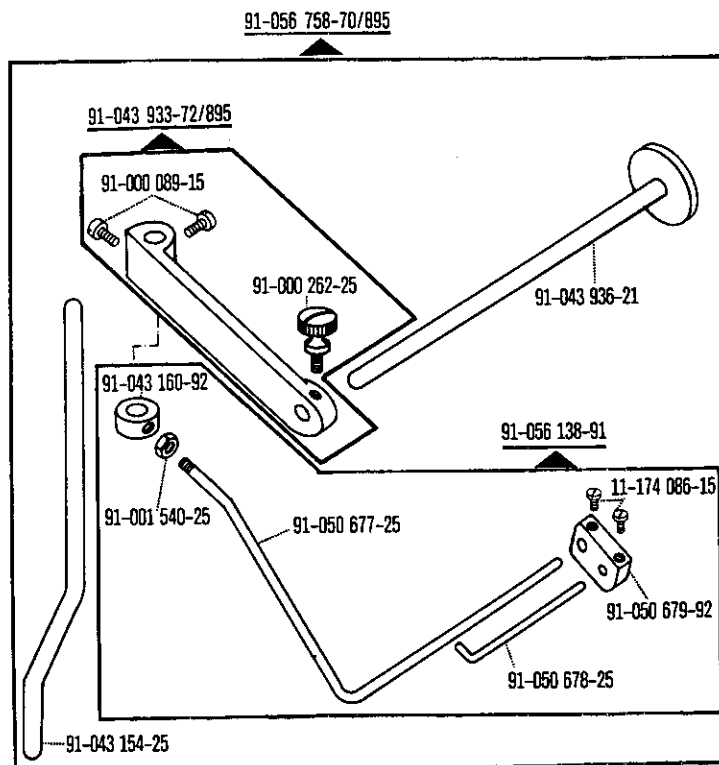
-716/06-83/03 (-900/..)

-17/31 (-900/..)  
 -716/08-17/82 (-900/..)  
 -716/08-39/82 (-900/..)  
 -716/18-17/82 (-900/..)  
 -716/18-39/82 (-900/..)





-17/31 (-900/..)  
 -39/31 (-900/..)



-716/06-82/12 (-900/..)

