

FORM 18920  
SEPTEMBER, 1935  
PRINTED IN U. S. A.

# LIST OF PARTS



**MACHINE No. 148-12**

---

**THE SINGER MANUFACTURING COMPANY**

## INSTRUCTIONS FOR OILING

The machine is equipped with an oil reservoir from which all the principal bearings receive a constant supply of oil, the oil flowing from the reservoir through the tubes.

When in continuous use, all other oiling points should be oiled at least twice each day with Singer Manufacturing Sewing Machine Oil (Stainless for White Goods).

Copyright, U. S. A., 1935,  
by The Singer Manufacturing Co.  
All Rights Reserved for all Countries

## INDEX

	Page
Accessories.....	18
Belt Guard.....	18
Foot Lifter Parts.....	19
Lap Seam Feller.....	19
Machine Base.....	18
Machine No. 148-12.....	5
Numerical List of Parts.....	21
Thread Unwinder.....	19

INSTRUCTIONS FOR ORDERING

In ordering from this list, use ONLY the part NUMBER in the FIRST column.

The number stamped on a Sewing Machine Part is in every case the number of the single part only.

Every combination of parts sent out as such has its specific number, which, although not stamped on the parts, must be used when ordering the combination.

Each number always indicates the SAME PART in whatever list it appears, or for whatever machine.

The letters after some of the numbers indicate the style of finish only, as follows:

A-Hardened, Polished, Nickel Plated and Buffed

B-Polished, Nickel Plated and Buffed

C-Hardened Only

D-Polished Only

E-Soft, Not Polished

F-Hardened and Polished

H-Blued

J-Nickel Plated Only

K-Hardened and Nickel Plated

L-Brass Plated

M-Oxidized

N-Japanned, Dull

P-Japanned, Bright

R-Merlized

T-Copper Plated

T.A-Hardened, Polished, Copper and Nickel Plated and Buffed

T.B-Copper and Nickel Plated and Polished

T.J-Copper and Nickel Plated Only

T.K-Hardened, Copper and Nickel Plated

T.M-Copper Plated and Oxidized

T.L-Copper and Brass Plated

U-Zinc Plated

V-Silver Plated

W-Polished and Nickel Plated

Y-Black Nickel Plated Only

Z-Chromium Plated

Z.B-Polished, Nickel Plated, Buffed and Chromium Plated

Z.J-Nickel and Chromium Plated

These letters MUST BE USED when they appear in the list; and AFTER the number as in the list.

In this series:

1 to 1500, 50001 to 51500 and 140001 to 142000 are Screw Numbers

1501 to 1800 and 51501 to 51800 are Nut Numbers

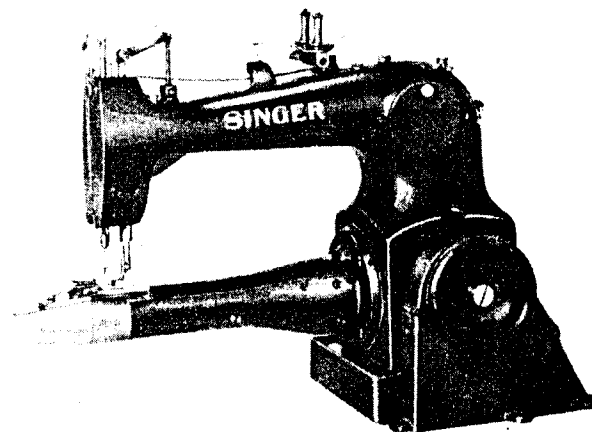
1801 to 2000 and 51801 to 52000 are Roller Numbers

2001 to 50000 and 52001 to 140001 and 142000 to 190000 are Sewing Machine Parts, 190001 and upward are numbers of Electrical Parts

The figures in the second column refer only to the plates, illustrating the parts, and are NOT TO BE USED in ordering.

Parts marked with an asterisk (\*) are furnished only when repairs are made at factory.

LIST OF PARTS COMPLETE FOR



MACHINE NO. 148-12

FOR TWO LINE STITCHING ON SHIRTS, PAJAMAS, MEDIUM AND LIGHT WEIGHT MATERIAL.

TWO NEEDLES, TWO LOOPERS, DOUBLE CHAIN-STITCH. GAUGES 1/8 IN., 5/32 IN., 3/16 IN., 7/32 IN. AND 1/4 INCH. SHORT NEEDLE BAR STROKE.

SPEED 3500 R.P.M. ACCORDING TO THE MATERIAL BEING STITCHED.

No.	Plate	Name
*128439	----	Arm with 15404 and two 15405.....
54913	9725	" Back Cover.....
54914	----	Arm Back Cover complete, Nos. 1538D, 50223D 54913, 54915, 54916 and two 1443J.....
54915	9721	Arm Back Cover Latch with 911E.....
50223D	9713	" " " " Hinge Screw.....
911E	9714	" " " " Screw Stud.....
1538D	9707	" " " " " " Thumb Nut.
54916	9721	" " " " Spring.....
1443J	9713	" " " " Screw.....
128440	9708	" Oil Cup (large) for oiling Crank Connecting Rod (upper) Bearing and Cylinder Rock Shaft Connecting Rod (upper) Bearing.....

No.	Plate	Name
68350	9708	Arm Oil Cup (small) for oiling Arm Rock Shaft front, intermediate and back bearings and Hand Wheel and Pulley Shaft bearings.....
138320	9708	Arm Oil Cup (small) Washer (leather) for 68350.....
52185	9708	Arm Oil Tube with 42367, for oiling 54711.
42367	9708	" " " Packing (braided cotton)....
128441	9723	" Rock Shaft.....
128003	9720	" " " Bushing (back).....
130869	9708	" " " " " Oil Pad (braided cotton).....
437C	9714	Arm Rock Shaft Bushing (back) Set Screw...
128442	9720	" " " " (front).....
128419	9708	" " " " " Oil Pad (braided cotton).....
888C	9714	Arm Rock Shaft Bushing (front) Set Screw..
54919	9720	" " " " (intermediate)....
130869	9708	" " " " " Oil Pad (braided cotton).....
50224C	9714	Arm Rock Shaft Bushing (intermediate) Set Screw.....
54921	9704	Arm Rock Shaft Collar with two 456C.....
456C	9712	" " " " Set Screw.....
128443	9720	" " " Crank (back) with two 50083C, for 128445.....
128006	9720	Arm Rock Shaft Crank (back) with two 50083C, for 128021.....
50083C	9713	Arm Rock Shaft Crank (back) Set Screw....
128444	9720	" " " " (front) with two 50135C.....
50135C	9713	Arm Rock Shaft Crank (front) Set Screw....
56016	9717	" Side Cover.....
51224D	9714	" " " Thumb Screw.....
128445	9718	Crank Connecting Rod complete, Nos. 217J, 1722E, 1723E, 54925, 55034, 128432 and 128448.....
*54925	----	Crank Connecting Rod (rod only).....
51043C	9714	" " " Ball Screw Stud.....
1597E	9707	" " " " " " Nut..
67425	9707	" " " " " " " Lock Washer.....
896E	9713	Crank Connecting Rod Cap (lower) Screw....
171E	9713	" " " " (upper) Screw....
*128447	----	" " " End Bearing (lower)..
*128430	----	" " " " (upper)..
*128448	----	" " " Head (lower) Nos. 128447 and two 896E.....

No.	Plate	Name
*128432	----	Crank Connecting Rod Head (upper) Nos. 51043C, 128430 and two 171E.....
138304	9708	Crank Connecting Rod Head (upper) Oil Pad (braided cotton).....
1722E	9707	Crank Connecting Rod Nut (lower).....
1723E	9707	" " " " (upper).....
55034	9711	" " " Position Plate.....
217J	9713	" " " " " Screw..
*128449	----	Cylinder with 452C, 460C, 824C, 50150C, 54664, 128032, 128033 and two 391J.....
54620	9711	Cylinder Dowel Pin.....
128450	9717	" End Cover with 128456.....
128451	----	Cylinder End Cover complete, Nos. 128128, 128450, 128455 and three 1231J.....
128452	----	Cylinder End Cover 128451 with 128453 and two 158J.....
128453	9717	Cylinder End Cover Extension.....
158J	9713	" " " " Screw.....
128454	9717	" " " Lock Stud.....
128455	----	" " " " " 128454 with 337J and 128457.....
*128456	----	Cylinder End Cover Lock Stud Housing.....
624C	9712	" " " " " Set Screw....
128457	9706	" " " " " Spring.....
337J	9712	" " " " " Screw..
*54625	----	" " " Slide (back).....
128128	9717	" " " " " 54625 with 54627 and 55165.....
50999F	9713	Cylinder End Cover Slide (back) Stop Screw
*55165	----	" " " " (front).....
54627	9711	" " " " " Hinge Pin..
1231J	9712	" " " " " Screw
128458	9718	" Rock Shaft.....
128015	9711	" " " Bushing (back).....
1125C	9712	" " " " " Set Screw.....
128459	9720	Cylinder Rock Shaft Bushing (front).....
220J	9712	" " " " " Screw..
128017	9720	" " " Crank with two 1253C..
1253C	9713	" " " " Set Screw.....
128460	9721	" " " Connection with 138308 and two each 152E and 175E.....
128461	----	Cylinder Rock Shaft Connection 128460 with 128458 and 128466.....
152E	9714	Cylinder Rock Shaft Connection Cap (large) Screw.....
175E	9713	Cylinder Rock Shaft Connection Cap (small) Screw.....

No.	Plate	Name
138308	9706	Cylinder Rock Shaft Connection Lubricating Pad (wood).....
128021	9718	Cylinder Rock Shaft Connecting Rod complete, Nos. 1722E, 1723E, 128022, 128025 and 128026.....
128022	----	Cylinder Rock Shaft Connecting Rod (rod only).....
50730C	9714	Cylinder Rock Shaft Connecting Rod Ball Screw Stud (lower).....
1664E	9707	Cylinder Rock Shaft Connecting Rod Ball Screw Stud (lower) Nut.....
50731C	9714	Cylinder Rock Shaft Connecting Rod Ball Screw Stud (upper).....
1597E	9707	Cylinder Rock Shaft Connecting Rod Ball Screw Stud (upper) Nut.....
171E	9713	Cylinder Rock Shaft Connecting Rod Cap (lower) Screw.....
171E	9713	Cylinder Rock Shaft Connecting Rod Cap (upper) Screw.....
*128024	----	Cylinder Rock Shaft Connecting Rod End Bearing (lower).....
*55032	----	Cylinder Rock Shaft Connecting Rod End Bearing (upper).....
125601	----	Cylinder Rock Shaft Connecting Rod End Bearing (upper) 55032 with two 171E....
128025	----	Cylinder Rock Shaft Connecting Rod Head (lower) Nos. 50730C, 128024 and two 171E
128026	----	Cylinder Rock Shaft Connecting Rod Head (upper) Nos. 217D, 50731C, 55034 and 125601.....
138304	9708	Cylinder Rock Shaft Connecting Rod Head (upper) Oil Pad (braided cotton).....
1722E	9707	Cylinder Rock Shaft Connecting Rod Nut (lower).....
1723E	9707	Cylinder Rock Shaft Connecting Rod Nut (upper).....
55034	9711	Cylinder Rock Shaft Connecting Rod Position Plate.....
217D	9713	Cylinder Rock Shaft Connecting Rod Position Plate Screw.....
*128434	----	Cylinder Rock Shaft Eccentric.....
*128465	----	" " " " Body.....
51426C	9713	" " " " Set Screw.....
128466	9720	Cylinder Rock Shaft Eccentric (adjustable) complete, Nos. 193E, 7071, 51145C, 128464, 128465 and two 51426C.....
51145C	9714	Cylinder Rock Shaft Eccentric Regulating Screw.....

No.	Plate	Name
193E	9714	Cylinder Rock Shaft Eccentric Set Screw...
7071	9707	" " " " " " "
		Washer.....
134D	9713	Cylinder Screw.....
128028	9706	" Thread Eyelet.....
128139	----	" " " 128028 with 128166.
1402J	9714	" " " Screw.....
128030	9720	" " Guard.....
1302J	9714	" " " Screw.....
128031	9722	" " Tube.....
128032	9719	" Top Cover (back).....
54664	9706	" " " Hinge Pin.....
460C	9712	" " " " Set Screw...
128033	9719	" " " (front) with 233J and 128034.....
391J	9713	Cylinder Top Cover (front) Screw.....
128034	9719	" " " " Spring.....
233J	9714	" " " " " Screw...
128467	9717	Face Plate.....
128468	----	Face Plate complete, Nos. 621J, 55184 and 128467.....
46111	9705	Face Plate Pin.....
55184	9711	" " Thread Guide.....
621J	9712	" " " " Screw.....
51224D	9714	" " Thumb Screw.....
50732C	9713	Feed Adjusting Screw (eccentric).....
1735J	9707	" " " Nut.....
128469	9709	" Dog, 16 teeth (16 teeth to the inch) for 138289.....
128471	9709	Feed Dog, 16 teeth (16 teeth to the inch) for 138293.....
50128C	9709	Feed Dog Screw.....
128472	9721	" Connecting Rod with two 896E.....
138302	----	" " " 128472 with 128475....
896E	9713	" " " Cap Screw.....
*128474	----	" Eccentric.....
128475	9720	Feed Eccentric (adjustable) complete, Nos. 193E, 7071, 51145C, 128474, 128476, 138306 and two 51426C.....
*128476	----	Feed Eccentric Body.....
51426C	9713	" " " Set Screw.....
138306	9708	" " Lubricating Pad (wood)....
51145C	9714	" " Regulating Screw.....
193E	9714	" " Set Screw.....
7071	9707	" " " Washer.....
128477	9704	" Lifting Eccentric with 138308 and two 462C.....
128478	----	Feed Lifting Eccentric 128477 with 128479.

No.	Plate	Name
138308	9706	Feed Lifting Eccentric Lubricating Pad (wood).....
462C	9712	Feed Lifting Eccentric Set Screw.....
128043	9725	" " Lever.....
128479	9721	" " " Connecting Rod with two 896E.....
896E	9713	Feed Lifting Lever Connecting Rod Cap Screw.....
50997C	9713	Feed Lifting Lever Connecting Rod Hinge Screw (eccentric).....
1722E	9707	Feed Lifting Lever Connecting Rod Hinge Screw Nut.....
128044	9706	Feed Lifting Lever Hinge Pin.....
452C	9712	" " " " " Set Screw....
128050	9723	" Rod.....
128051	9711	" " Connecting Link (left).....
128052	9711	" " " " (right).....
50733C	9713	" " " " Hinge Screw.....
1735J	9707	" " " " " Nut..
128053	9720	" " Hinge Bracket with 50150C.....
128054	9718	" " " " Hinge Pin.....
50150C	9712	" " " " " Set Screw
128055	9706	" " " Pin.....
50150C	9712	" " " " " Set Screw.....
138309	9725	Hand Wheel and Pulley with two 448C.....
448C	9714	" " " " " Set Screw.....
128482	9718	" " " " Shaft with 138308...
128483	----	" " " " " 128482 with 128448.....
128484	----	Hand Wheel and Pulley Shaft 128483 with 128461,128478 and 138302.....
138310	9717	Hand Wheel and Pulley Shaft Bushing (right).....
138311	----	Hand Wheel and Pulley Shaft Bushing (right) 138310 with 138312 and 138316..
138312	9715	Hand Wheel and Pulley Shaft Bushing (right) Oil Pad (inside) wick.....
138316	9715	Hand Wheel and Pulley Shaft Bushing (right) Oil Pad (outside) wick.....
888C	9714	Hand Wheel and Pulley Shaft Bushing (right) Set Screw.....
138314	9720	Hand Wheel and Pulley Shaft Flanged Bushing (left).....
138315	----	Hand Wheel and Pulley Shaft Flanged Bushing (left) 138314 with 138312 and 138313.....
138312	9715	Hand Wheel and Pulley Shaft Flanged Bushing (left) Oil Pad (inside) wick.....

No.	Plate	Name
138313	9715	Hand Wheel and Pulley Shaft Flanged Bushing (left) Oil Pad (outside) wick.....
445C	9712	Hand Wheel and Pulley Shaft Flanged Bushing (left) Set Screw.....
138308	9706	Hand Wheel and Pulley Shaft Lubricating Pad (wood).....
150D	9712	Hand Wheel and Pulley Shaft Screw.....
128485	9704	Looper (back).....
128059	9711	" " Carrier with 1454C.....
1454C	9713	" " " Clamping Screw.....
128486	9704	" (front).....
128061	9711	" " Carrier with 1454C.....
1454C	9713	" " " Clamping Screw.....
399J	9712	" Screw.....
54708	9718	Needle Bar (hollow).....
128488	----	Needle Bar complete, Nos. 54708 and 128489
54710	9711	" " Bushing (lower).....
563C	9714	" " " " Set Screw.....
54710	9711	" " " (upper).....
563C	9714	" " " " Set Screw.....
*54711	9711	" " Connecting Link.....
55003	----	" " " " 54711 with 54712 and 54713.....
54712	9711	Needle Bar Connecting Link Hinge Stud....
1520J	9707	" " " " " Nut.
54713	9711	" " " Stud with 207E.....
207E	9713	" " " Clamping Screw.
128489	9711	" Clamp with two 1498F.....
128490	9711	" Guard (back) for 1/4 in. gauge and below.....
233J	9714	Needle Guard (back) Screw.....
128063	9711	" " (front) for 1/4 in. gauge and below.....
233J	9714	Needle Guard (front) Screw.....
54977	9711	" " Holder.....
185J	9713	" " " Screw.....
1498F	9712	" Set Screw.....
128491	9719	Oil Reservoir.....
128492	----	" " 128491 with 128493, 128494 and two 330J.....
138303	----	Oil Reservoir complete, Nos. 128492,128496 128500,138253,138256,138259,138262, 138264 and 138267.....
128493	9719	Oil Reservoir Cover.....
128494	9719	" " " Gasket.....
330J	9713	" " " Screw.....
*128495	----	" " Oil Pipe.....
128496	9722	Oil Reservoir Oil Pipe 128495 with 68350 and 128497, for filling oil reservoir..

No.	Plate	Name
68350	9708	011 Reservoir Oil Pipe Cup.....
*128497	----	" " " " Head.....
128498	9710	" " " Tube with 138269, for 128500.....
128499	9710	011 Reservoir Oil Tube Wick for 128500....
128500	----	011 Reservoir Oil Tube complete, for oil- ing Cylinder Rock Shaft Bushing (back) Nos. 51630,128498,128499 and 138268....
138251	9710	011 Reservoir Oil Tube with 138269, for 138253.....
138252	9710	011 Reservoir Oil Tube Wick for 138253....
138253	----	011 Reservoir Oil Tube complete for oiling Cylinder Rock Shaft Connecting Rod (lower) Bearing, Nos. 51630,138251, 138252 and 138268.....
138254	9710	011 Reservoir Oil Tube with 138269, for 138256.....
138255	9710	011 Reservoir Oil Tube Wick for 138256....
138256	----	011 Reservoir Oil Tube complete, for oil- ing Cylinder Rock Shaft Connection (front) Bearing, Nos. 51630, 138254, 138255 and 138268.....
138257	9710	011 Reservoir Oil Tube with 138269, for 138259.....
138258	9710	011 Reservoir Oil Tube Wick for 138259....
138259	----	011 Reservoir Oil Tube complete for oiling Feed Connecting Rod, Nos. 51630,138257, 138258 and 138268.....
138260	9708	011 Reservoir Oil Tube with 138269 for 138262.....
138261	9708	011 Reservoir Oil Tube Wick for 138262....
138262	----	011 Reservoir Oil Tube complete, for oil- ing Cylinder Rock Shaft Connection (back) Bearing, Nos. 51630,138260, 138261 and 138268.....
138263	9708	011 Reservoir Oil Tube with 138269, for 138264.....
133258	9710	011 Reservoir Oil Tube Wick for 138264....
138264	----	011 Reservoir Oil Tube complete, for oil- ing Feed Lifting Lever Connecting Rod, Nos. 51630,138258,138263 and 138268....
138265	9708	011 Reservoir Oil Tube with 138269, for 138267.....
138266	9708	011 Reservoir Oil Tube Wick for 138267....
138267	----	011 Reservoir Oil Tube complete, for oil- ing Crank Connecting Rod (lower) Bear- ing, Nos. 51630,138265,138266 and 138268.....
138268	9708	011 Reservoir Oil Tube Coupling.....

No.	Plate	Name
*138269	----	Oil Reservoir Oil Tube Ferrule.....
51630	9708	" " " " Lock Nut.....
50195D	9713	" " " Screw.....
22434	9707	" " " Washer (leather).....
55084	9723	Presser Bar (lower).....
128064	9720	" " " Bushing.....
563C	9714	" " " " Set Screw.....
128065	9722	" " (upper).....
128066	9706	" " " Guide Bracket with 440C.....
440C	9714	Presser Bar (upper) Guide Bracket Set Screw.....
128067	9720	Presser Bar Connecting Bracket with 448C and 453C.....
448C	9714	Presser Bar Connecting Bracket Set Screw (long).....
453C	9712	Presser Bar Connecting Bracket Set Screw (short).....
128068	9723	Presser Bar Lifter.....
128069	9723	" " " Connecting Link.....
50116E	9714	" " " " Hinge Screw (lower).....
108F	9712	Presser Bar Lifter Connecting Link Hinge Screw (upper).....
50415C	9713	Presser Bar Lifter Hinge Screw.....
2269	9706	" " " Stop Pin (lower).....
2049	9706	" " " " " (upper).....
128070	9722	" " " Lifting Lever.....
128071	9723	" " " " Extension.....
161C	9713	" " " " Screw.....
866D	9713	" " " " Hinge Screw.....
184D	9714	" " " " Stop Screw.....
128072	9723	" " " Spring (flat).....
54722	9706	" " " Stud.....
28276	9704	" " Foot Hinge Pin.....
128329	----	" " Plate.....
128339	----	" " Shank.....
128330	9704	Presser Foot (hinged) complete, for 1/8 in. to 3/16 in. gauges, Nos. 26276, 128329 and 128339.....
26276	9704	Presser Foot Hinge Pin.....
128346	----	" " Plate.....
128339	----	" " Shank.....
128347	9704	Presser Foot (hinged) complete, for 7/32 in. gauge and above, Nos. 26276, 128339 and 128346.....
176J	9713	Presser Foot Screw.....
50132W	9714	Pressure Regulating Thumb Screw.....
1543W	9707	" " " " Lock Nut..

## PARTS FOR MACHINE 148-12

No.	Plate	Name
128075	9721	Tension (under thread) Bracket.....
176J	9713	" " " " Screw.....
2102	9705	" " " " Disc.....
51570C	9705	" " " " Regulating Thumb Nut.....
128076	9705	Tension (under thread) Releaser.....
233J	9714	" " " " Adjusting Screw.....
50076D	9705	Tension (under thread) Releaser Hinge Screw.....
32572	9705	Tension (under thread) Releasing Disc.....
128077	9722	" " " " Lever....
63824	9705	" " " " " " Spring.....
1144J	9712	Tension (under thread) Releasing Lever Spring Screw.....
128078	9705	Tension (under thread) Releasing Pin.....
50326C	9705	" " " " Screw Stud.....
59539	----	" " " " " " 50326C with 51570C.....
59534	9705	Tension (under thread) Spring.....
59537	9705	" " " " " " Bushing (large).....
59538	9705	Tension (under thread) Spring Bushing (small).....
57076	9705	Tension (under thread) Thread Guide.....
138270	9721	" (upper thread) Bracket.....
376J	9705	" " " " " " Screw.....
2102	9705	" " " " " " Disc.....
51570C	9705	" " " " " " Regulating Thumb Nut.....
32572	9705	Tension (upper thread) Releasing Disc.....
54988	9705	" " " " " " Pin.....
138271	9718	" " " " " " Shaft....
128082	9704	" " " " " " Crank with 452C.....
54873	9718	Tension (upper thread) Releasing Shaft Crank Link.....
110C	9712	Tension (upper thread) Releasing Shaft Crank Link Hinge Screw.....
452C	9712	Tension (upper thread) Releasing Shaft Crank Set Screw.....
138317	9707	Tension (upper thread) Releasing Shaft Spring.....
316C	9714	Tension (upper thread) Releasing Shaft Stop Screw.....
1547J	9707	Tension (upper thread) Releasing Shaft Stop Screw Nut.....
50326C	9705	Tension (upper thread) Screw Stud.....

No.	Plate	Name
59539	----	Tension (upper thread) Screw Stud 50326C with 51570C.....
59536	9707	Tension (upper thread) Spring.....
59537	9705	" " " " " " Bushing (large).....
59538	9705	Tension (upper thread) Spring Bushing (small).....
57076	9705	Tension (upper thread) Thread Guide.....
128083	9723	" Releasing Arm with 51818.....
128084	9722	" " " " Connecting Rod.....
1521J	9707	" " " " " " Nut
1131C	9713	" " " " Hinge Screw.....
51818	9712	" " " " Roller and Screw Stud.....
*138272	----	Thread (under) Protector (left).....
138273	9720	" " " " " " 138272 with 138300.....
*138274	----	Thread (under) Protector (right).....
138275	9720	" " " " " " 138274 with 138300.....
138300	----	Thread (under) Protector Holder.....
335J	9712	" " " " " " Screw.....
128387	9720	" " " " " " Separator (back).....
335J	9712	" " " " " " Screw....
128166	----	" " " " " " (front) with 128094,128095,128167 and two 728D....
128095	9715	Thread (under) Separator (front) Thread Guide.....
128167	9715	Thread (under) Separator (front) Thread Retainer (left).....
128094	9715	Thread (under) Separator (front) Thread Retainer (right).....
728D	9712	Thread (under) Separator (front) Thread Retainer Screw.....
138276	9720	Thread (under) Take-up with two 465C....
138280	9719	" " " " " " Frame.....
138281	----	Thread (under) Take-up Frame complete, Nos. 128105,138280 and 138282.....
*138282	9719	Thread (under) Take-up Frame Cover with 50150C.....
128105	9721	Thread (under) Take-up Frame Cover Hinge Pin.....
50150C	9712	Thread (under) Take-up Frame Cover Hinge Pin Set Screw.....
1149D	9713	Thread (under) Take-up Frame Screw.....
465C	9712	" " " " " " Set Screw.....
138277	9721	" " " " " " Stripper.....
138278	9711	" " " " " " Bracket..



No.	Plate	Name
1364C	9714	Thread (under) Take-up Stripper Bracket Screw.....
330J	9713	Thread (under) Take-up Stripper Screw.....
128081	9707	" " " " " Wash-er.....
138279	9721	Thread (under) Take-up Thread Guard with 220J.....
128100	9704	Thread (under) Take-up Thread Guard Bracket.....
1364C	9714	Thread (under) Take-up Thread Guard Bracket Screw.....
1137E	9715	Thread (under) Take-up Thread Guard Hinge Screw.....
128101	9711	Thread (under) Take-up Thread Guard Spring
335J	9712	" " " " " " Screw.....
220J	9712	Thread (under) Take-up Thread Guard Stop Screw.....
138283	9706	Thread (upper) Controller.....
125564	9721	" " " " Lever with 50138F
54879	9721	" " " " Connection
999F	9714	" " " " " Hinge Screw (lower).....
999F	9714	Thread (upper) Controller Lever Connection Hinge Screw (upper).....
1700E	9707	Thread (upper) Controller Lever Connection Hinge Screw (upper) Nut.....
125566	9706	Thread (upper) Controller Lever Hinge Stud
465C	9712	" " " " " " Set Screw.....
125567	9721	Thread (upper) Controller Lever Post with 465C.....
443C	9714	Thread (upper) Controller Lever Post Set Screw.....
50138F	9712	Thread (upper) Controller Set Screw.....
128107	9706	" " " " Thread Guide....
128108	9721	" " " " " Post
175F	9713	" " " " " " Set Screw.....
226J	9712	Thread (upper) Controller Thread Guide Screw.....
138284	9715	Thread (upper) Take-up Bracket.....
138285	9715	" " " " Eyelet with 2084...
2084	9715	" " " " " Steady Pin..
138286	9706	" " " " Stripper.....
128114	9715	" " " " " Bracket...
1492J	9713	" " " " " Screw
226J	9712	" " " " " Screw.....
138287	9706	" " " " " Thread Retainer....

No.	Plate	Name
68164	9715	Thread (upper) Take-up Thread Retainer Spring.....
1145H	9714	Thread (upper) Take-up Thread Retainer Spring Screw.....
138288	----	Thread (upper) Take-up complete, Nos.1145H 68164, 138284, 138285 and 138287.....
330J	9713	Thread (upper) Take-up Screw.....
138289	9709	Throat Plate for 1/8 in. to 5/32 in. gauges for 128469, for 138290.....
138290	----	Throat Plate 138289 with 138295 and two 228D.....
138293	9709	Throat Plate for 3/16 in. to 1/4 in. gauges for 128471, for 138294.....
138294	----	Throat Plate 138293 with 138295 and two 228D.....
138295	9709	Throat Plate Body and Lap Seam Feller Holder.....
1319F	9709	Throat Plate Body and Lap Seam Feller Holder Screw.....
228D	9709	Throat Plate Screw.....
*15404	----	Trade Mark.....
15405	----	" " Rivet.....

Genuine Singer Needles should be used in Singer Machines. These Needles and their Containers are marked with the Company's Trade Mark "SIMANCO." 1

Needles in Containers marked "For Singer Machines" are not Singer made needles. 2

## MACHINE BASE

No.	Plate	Name
138296	9725	Machine Base.....
138297	----	Machine Base complete, Nos. 131019, 131020 132618, 138296, three wood screws 2 in. No. 12 F.H. and four each 131F, 138298 and 138299.....
131019	9722	Machine Base Oil Pipe.....
131020	9722	" " " " Oil Valve.....
138298	9722	" Cushion (large) felt.....
138299	9716	" " (small) felt.....
132618	9716	" " " felt.....
131F	9715	" " " Screw for 138297..

## ACCESSORIES

No.	Plate	Name
1407J	5563	Machine Thumb Screw, for 3 in. table.....
1408J	5563	" " " " 2 in. table.....
14063	9722	" " " Spring.....
9842	9707	" " " Washer.....
120344	9724	Oiler (copper plated) with 120345.....
120345	9724	" Spout, 4 1/2 in. long.....
26026	9724	Screw Driver (large).....
26485	9724	" " (small).....
120341	9724	Tweezers (curved).....
4822	9724	Wrench for 1521 and 1547.....
8908	9724	" " 1664, 1722 and 1723.....

## BELT GUARD

No.	Plate	Name
128171	9725	Belt Guard (lower).....
128172	9725	" " (upper).....
63505	9711	" " " Hinge Pin.....
743382	9704	" " " Lock Spring.....
2273	9715	" " " " " Position Pin.....
331D	9713	Belt Guard (upper) Lock Spring Screw.....
128173	----	Belt Guard complete, Nos. 331D, 2273, 63505, 128171, 128172, 743382 and three wood screws 1 in. No. 10.....

## LAP SEAM FELLER

## ON SLIDE

No.	Plate	Name
121266	9709	Lap Seam Feller on Slide.....
121267	----	" " " 121266 with 121268 and two 1443J.....
1443J	9713	Lap Seam Feller Screw.....
19294	9706	" " " Spring.....
405J	9712	" " " " Screw.....
26277	9720	Holder.....
1443J	9713	" Screw.....
121268	9709	Slide with 10165.....
10165	9715	" Steady Pin.....

## FOOT LIFTER PARTS

No.	Plate	Name
6439	----	Chain, 36 in. to 45 in., with 56864 and 56865.....
Note: When ordering No. 6439, give length required.		
4879	9716	Chain Connecting Link.....
56864	9718	" Hook (large).....
56865	9716	" " (small).....
126249	9725	Treadle.....
4882	9721	" Shaft.....
126250	9721	" Spring.....
150451	9725	" Stand.....
150452	----	Treadle complete, Nos. 4879, 4882, 126249, 126250, 150451 and two wood screws 1 in. No. 16 F.H.....

## THREAD UNWINDER

## FOR FOUR SPOOLS

No.	Plate	Name
225257	9505	Spool Rest (for two spools) with 201018C..
150203	9505	" " Cushion.....
225388	9505	" " Rod.....
200383C	9712	" " " Set Screw.....
201018C	9712	" " " Set Screw.....
202490	9505	" Stand with 200383C.....

## THREAD UNWINDER

No.	Plate	Name
225391	9505	Thread Guide.....
201696J	9707	" " Lock Nut.....
225326	9707	" " Position Cup.....
225324	9505	" " Rod with 208E and 225322.....
208E	9712	" " " Screw.....
225322	9707	" " " Washer.....
*150057	----	" Separator.....
150058	9505	" " 150057 with 150059.....
*150059	----	" " Bracket.....
150060	9505	" " " Arm with 164J and 9525.....
164J	9712	Thread Separator Bracket Arm Clamping Screw.....
9525	9707	Thread Separator Bracket Arm Clamping Screw Washer.....
164J	9712	Thread Separator Bracket Arm Screw.....
9525	9707	" " " " " Washer.
150061	----	Thread Separator complete, Nos. 164J, 9525 150058 and 150060.....
150062	9505	Thread Unwinder complete, for four spools, Nos. 150061, 201696J, 202490, 225324, 225326, 225388, two 225257, three wood screws 7/8 in. No. 12 and four each 150203 and 225391.....
27739	9724	Thread Cone (wood) for large cones.....
225390	9724	" " Holder, for inverted cones....

Note: Nos. 27739 and 225390 are used with, but not included in 150062.

Genuine Singer Needles should be used  
in Singer Machines.  
These Needles and their Containers  
are marked with the  
Company's Trade Mark "SIMANCO." 1

Needles in Containers marked  
"For Singer Machines"  
are not Singer made needles. 2

## NUMERICAL LIST OF PARTS

**NUMERICAL LIST OF PARTS**  
**FOR**  
**MACHINE No. 148-12**

No.	Plate	Name
108F	9712	Presser Bar Lifter Connecting Link Hinge Screw (upper).....
110C	9712	Tension (upper thread) Releasing Shaft Crank Link Hinge Screw.....
131F	9715	Machine Cushion (small) Screw for 138297..
134D	9713	Cylinder Screw.....
150D	9712	Hand Wheel and Pulley Shaft Screw.....
152E	9714	Cylinder Rock Shaft Connection Cap (large) Screw for 128460.....
158J	9713	Cylinder End Cover Extension Screw for 128452.....
161C	9713	Presser Bar Lifting Lever Extension Screw.
164J	9712	Thread Unwinder Thread Separator Bracket Arm Clamping Screw for 150060.....
164J	9712	Thread Unwinder Thread Separator Bracket Arm Screw for 150061.....
171E	9713	Crank Connecting Rod Cap (upper) Screw for 128432.....
171E	9713	Cylinder Rock Shaft Connecting Rod Cap (lower) Screw for 128025.....
171E	9713	Cylinder Rock Shaft Connecting Rod Cap (upper) Screw for 125601.....
175E	9713	Cylinder Rock Shaft Connection Cap (small) Screw for 128460.....
175F	9713	Thread (upper) Controller Thread Guide Post Set Screw.....
176J	9713	Presser Foot Screw.....
176J	9713	Tension (under thread) Bracket Screw.....
184D	9714	Presser Bar Lifting Lever Stop Screw.....
185J	9713	Needle Guard Holder Screw.....
193E	9714	Cylinder Rock Shaft Eccentric Set Screw for 128466.....
193E	9714	Feed Eccentric Set Screw for 128475.....
207E	9713	Needle Bar Connecting Stud Clamping Screw for 54713.....
208E	9712	Thread Unwinder Thread Guide Rod Screw for 225324.....
217J	9713	Crank Connecting Rod Position Plate Screw for 128445.....
217D	9713	Cylinder Rock Shaft Connecting Rod Position Plate Screw for 128026.....
220J	9712	Cylinder Rock Shaft Bushing (front) Screw.
220J	9712	Thread (under) Take-up Thread Guard Stop Screw for 138279.....
226J	9712	Thread (upper) Controller Thread Guide Screw.....

No.	Plate	Name
226J	9712	Thread (upper) Take-up Stripper Screw.....
228D	9709	Throat Plate Screw for 138290 and 138294..
233J	9714	Cylinder Top Cover (front) Spring Screw for 128033.....
233J	9714	Needle Guard (back) Screw.....
233J	9714	" " (front) Screw.....
233J	9714	Tension (under thread) Releaser Adjusting Screw.....
316C	9714	Tension (upper thread) Releasing Shaft Stop Screw.....
330J	9713	Oil Reservoir Cover Screw for 128492.....
330J	9713	Thread (under) Take-up Stripper Screw.....
330J	9713	" (upper) Take-up Screw.....
331D	9713	Belt Guard (upper) Lock Spring Screw for 128173.....
335J	9712	Thread (under) Protector Screw.....
335J	9712	" " Separator (back) Screw.....
335J	9712	" " Take-up Thread Guard Spring Screw.....
337J	9712	Cylinder End Cover Lock Stud Spring Screw for 128455.....
376J	9705	Tension (upper thread) Bracket Screw.....
391J	9713	Cylinder Top Cover (front) Screw for 128449.....
399J	9712	Looper Screw.....
405J	9712	Lap Seam Feller Spring Screw.....
437C	9714	Arm Rock Shaft Bushing (back) Set Screw...
440C	9714	Presser Bar (upper) Guide Bracket Set Screw for 128066.....
443C	9714	Thread (upper) Controller Lever Post Set Screw.....
445C	9712	Hand Wheel and Pulley Shaft Flanged Bush- ing (left) Set Screw.....
448C	9714	Hand Wheel and Pulley Set Screw for 138309
448C	9714	Presser Bar Connecting Bracket Set Screw (long) for 128067.....
452C	9712	Feed Lifting Lever Hinge Pin Set Screw for 128449.....
452C	9712	Tension (upper thread) Releasing Shaft Crank Set Screw for 128082.....
453C	9712	Presser Bar Connecting Bracket Set Screw (short) for 128067.....
456C	9712	Arm Rock Shaft Collar Set Screw for 54921.
460C	9712	Cylinder Top Cover Hinge Pin Set Screw for 128449.....
462C	9712	Feed Lifting Eccentric Set Screw for 128477.....
465C	9712	Thread (under) Take-up Set Screw for 138276.....

No.	Plate	Name
465C	9712	Thread (upper) Controller Lever Hinge Stud Set Screw for 125587.....
563C	9714	Needle Bar Bushing (lower) Set Screw.....
563C	9714	" " (upper) Set Screw.....
563C	9714	Presser Bar (lower) Bushing Set Screw.....
621J	9712	Face Plate Thread Guide Screw for 128468..
624C	9712	Cylinder End Cover Lock Stud Set Screw for 128449.....
726D	9712	Thread (under) Separator (front) Thread Retainer Screw for 128166.....
866D	9713	Presser Bar Lifting Lever Hinge Screw.....
886C	9714	Arm Rock Shaft Bushing (front) Set Screw..
888C	9714	Hand Wheel and Pulley Shaft Bushing (right) Set Screw.....
896E	9713	Crank Connecting Rod Cap (lower) Screw for 128448.....
896E	9713	Feed Connecting Rod Cap Screw for 128472..
896E	9713	" Lifting Lever Connecting Rod Cap Screw for 128479.....
911E	9714	Arm Back Cover Latch Screw Stud for 54915.
999F	9714	Thread (upper) Controller Lever Connection Hinge Screw (lower).....
999F	9714	Thread (upper) Controller Lever Connection Hinge Screw (upper).....
1125C	9712	Cylinder Rock Shaft Bushing (back) Set Screw.....
1131C	9713	Tension Releasing Arm Hinge Screw.....
1137E	9715	Thread (under) Take-up Thread Guard Hinge Screw.....
1144J	9712	Tension (under thread) Releasing Lever Spring Screw.....
1145H	9714	Thread (upper) Take-up Thread Retainer Spring Screw for 138288.....
1149D	9713	Thread (under) Take-up Frame Screw.....
1231J	9712	Cylinder End Cover Slide (front) Screw for 128451.....
1253C	9713	Cylinder Rock Shaft Crank Set Screw for 128017.....
1302J	9714	Cylinder Thread Guard Screw.....
1319F	9709	Throat Plate Body and Lap Seam Feller Holder Screw.....
1364C	9714	Thread (under) Take-up Stripper Bracket Screw.....
1364C	9714	Thread (under) Take-up Thread Guard Brack- et Screw.....
1402J	9714	Cylinder Thread Eyelet Screw.....
1407J	5563	Machine Thumb Screw for 3 in. table (Ac- cessories).....

No.	Plate	Name
1408J	5563	Machine Thumb Screw for 2 in. table (Accessories).....
1443J	9713	Arm Back Cover Spring Screw for 54914.....
1443J	9713	Lap Seam Feller Holder Screw.....
1443J	9713	" " " Screw for 121267.....
1454C	9713	Looper (back) Carrier Clamping Screw for 128059.....
1454C	9713	Looper (front) Carrier Clamping Screw for 128061.....
1492J	9713	Thread (upper) Take-up Stripper Bracket Screw.....
1498F	9712	Needle Set Screw for 128489.....
1520J	9707	Needle Bar Connecting Link Hinge Stud Nut.
1521J	9707	Tension Releasing Arm Connecting Rod Nut..
1538D	9707	Arm Back Cover Latch Screw Stud Thumb Nut for 54914.....
1543W	9707	Pressure Regulating Thumb Screw Lock Nut..
1547J	9707	Tension (upper thread) Releasing Shaft Stop Screw Nut.....
1597E	9707	Crank Connecting Rod Ball Screw Stud Nut..
1597E	9707	Cylinder Rock Shaft Connecting Rod Ball Screw Stud (upper) Nut.....
1664E	9707	Cylinder Rock Shaft Connecting Rod Ball Screw Stud (lower) Nut.....
1700E	9707	Thread (upper) Controller Lever Connection Hinge Screw (upper) Nut.....
1722E	9707	Crank Connecting Rod Nut (lower) for 128445.....
1722E	9707	Cylinder Rock Shaft Connecting Rod Nut (lower) for 128021.....
1722E	9707	Feed Lifting Lever Connecting Rod Hinge Screw Nut.....
1723E	9707	Crank Connecting Rod Nut (upper) for 128445.....
1723E	9707	Cylinder Rock Shaft Connecting Rod Nut (upper) for 128021.....
1735J	9707	Feed Adjusting Screw Nut.....
1735J	9707	" Rod Connecting Link Hinge Screw Nut..
2049	9706	Presser Bar Lifter Stop Pin (upper).....
2084	9715	Thread (upper) Take-up Eyelet Steady Pin for 139285.....
2102	9705	Tension (under thread) Disc.....
2102	9705	" (upper thread) Disc.....
2269	9706	Presser Bar Lifter Stop Pin (lower).....
2273	9715	Belt Guard (upper) Lock Spring Position Pin for 128173.....
4822	9724	Wrench for 1521 and 1547 (Accessories)....
4879	9716	Chain Connecting Link for 150452.....
4882	9721	Treadle Shaft for 150452.....

No.	Plate	Name
6439	----	Chain 36 in. to 45 in. with 56864 and 56865.....
7071	9707	Cylinder Rock Shaft Eccentric Set Screw Washer for 128466.....
7071	9707	Feed Eccentric Set Screw Washer for 128475
8908	9724	Wrench for 1664,1722 and 1723(Accessories)
9525	9707	Thread Unwinder Thread Separator Bracket Arm Clamping Screw Washer for 150060...
9525	9707	Thread Unwinder Thread Separator Bracket Arm Screw Washer for 150061.....
9842	9707	Machine Thumb Screw Spring Washer (Accessories).....
10165	9715	Lap Seam Feller Slide Steady Pin for 121268.....
14063	9722	Machine Thumb Screw Spring (Accessories)..
*15404	----	Trade Mark for 128439.....
15405	----	" " Rivet for 128439.....
19294	9706	Lap Seam Feller Spring.....
22434	9707	Oil Reservoir Screw Washer (leather).....
26026	9724	Screw Driver (large) Accessories.....
26276	9704	Presser Foot Hinge Pin for 128330 and 128347.....
26277	9720	Lap Seam Feller Holder.....
26485	9724	Screw Driver (small) Accessories.....
27739	9724	Thread Unwinder Thread Cone (wood) for large cones for 150062.....
32572	9705	Tension (under thread) Releasing Disc....
32572	9705	" (upper thread) Releasing Disc....
42367	9708	Arm Oil Tube Packing (braided cotton) for 52185.....
46111	9705	Face Plate Pin.....
50076D	9705	Tension (under thread) Releaser Hinge Screw.....
50083C	9713	Arm Rock Shaft Crank (back) Set Screw for 128006 and 128443.....
50116E	9714	Presser Bar Lifter Connecting Link Hinge Screw (lower).....
50128C	9709	Feed Dog Screw.....
50132W	9714	Pressure Regulating Thumb Screw.....
50135C	9713	Arm Rock Shaft Crank (front) Set Screw for 128444.....
50138F	9712	Thread (upper) Controller Set Screw for 125564.....
50150C	9712	Feed Rod Hinge Bracket Hinge Pin Set Screw for 128449.....
50150C	9712	Feed Rod Hinge Pin Set Screw for 128053...
50150C	9712	Thread (under) Take-up Frame Cover Hinge Pin Set Screw for 138282.....
50195D	9713	Oil Reservoir Screw.....

## NUMERICAL LIST OF PARTS

No.	Plate	Name
50223D	9713	Arm Back Cover Latch Hinge Screw for 54914
50224C	9714	Arm Rock Shaft Bushing (intermediate) Set Screw.....
50326C	9705	Tension (under thread) Screw Stud for 59539.....
50326C	9705	Tension (upper thread) Screw Stud for 59539.....
50415C	9713	Presser Bar Lifter Hinge Screw.....
50730C	9714	Cylinder Rock Shaft Connecting Rod Ball Screw Stud (lower) for 128025.....
50731C	9714	Cylinder Rock Shaft Connecting Rod Ball Screw Stud (upper) for 128026.....
50732C	9713	Feed Adjusting Screw (eccentric).....
50733C	9713	" Rod Connecting Link Hinge Screw.....
50997C	9713	" Lifting Lever Connecting Rod Hinge Screw (eccentric).....
50999F	9713	Cylinder End Cover Slide (back) Stop Screw
51043C	9714	Crank Connecting Rod Ball Screw Stud for 128432.....
51145C	9714	Cylinder Rock Shaft Eccentric Regulating Screw for 128466.....
51145C	9714	Feed Eccentric Regulating Screw for 128475
51224D	9714	Arm Side Cover Thumb Screw.....
51224D	9714	Face Plate Thumb Screw.....
51426C	9713	Cylinder Rock Shaft Eccentric Body Set Screw for 128466.....
51426C	9713	Feed Eccentric Body Set Screw for 128475..
51570C	9705	Tension (under thread) Regulating Thumb Nut for 59539.....
51570C	9705	Tension (upper thread) Regulating Thumb Nut for 59539.....
51630	9708	Oil Reservoir Oil Tube Lock Nut for 128500 138253,138256,138259,138262,138264 and 138267.....
51818	9712	Tension Releasing Arm Roller and Screw Stud for 128083.....
52185	9708	Arm Oil Tube with 42367 for oiling 54711..
54620	9711	Cylinder Dowel Pin.....
*54625	----	" End Cover Slide (back) for 128128
54627	9711	" " " " (front) Hinge Pin for 128128.....
54664	9706	Cylinder Top Cover Hinge Pin for 128449..
54708	9718	Needle Bar (hollow) for 128488.....
54710	9711	" " Bushing (lower).....
54710	9711	" " " (upper).....
*54711	9711	" " Connecting Link for 55003.....
54712	9711	" " " " Hinge Stud for 55003.....

## NUMERICAL LIST OF PARTS

No.	Plate	Name
54713	9711	Needle Bar Connecting Stud with 207E, for 55003.....
54722	9706	Presser Bar Spring Stud.....
54873	9718	Tension (upper thread) Releasing Shaft Crank Link.....
54879	9721	Thread (upper) Controller Lever Connection
54913	9725	Arm Back Cover for 54914.....
54914	----	Arm Back Cover complete, Nos. 1538D,50223D 54913,54915,54916 and two 1443J.....
54915	9721	Arm Back Cover Latch with 911E for 54914..
54916	9721	Arm Back Cover Spring for 54914.....
54919	9720	Arm Rock Shaft Bushing (intermediate).....
54921	9704	" " " Collar with two 456C.....
*54925	----	Crank Connecting Rod (rod only) for 128445
54977	9711	Needle Guard Holder.....
54988	9705	Tension (upper thread) Releasing Pin.....
55003	----	Needle Bar Connecting Link 54711 with 54712 and 54713.....
*55032	----	Cylinder Rock Shaft Connecting Rod End Bearing (upper) for 125801.....
55034	9711	Crank Connecting Rod Position Plate for 128445.....
55034	9711	Cylinder Rock Shaft Connecting Rod Position Plate for 128026.....
55084	9723	Presser Bar (lower).....
*55165	----	Cylinder End Cover Slide (front) for 128128.....
55184	9711	Face Plate Thread Guide for 128468.....
56016	9717	Arm Side Cover.....
56864	9716	Chain Hook (large) for 6439.....
56865	9716	" " (small) for 6439.....
57076	9705	Tension (under thread) Thread Guide.....
57076	9705	" (upper thread) Thread Guide.....
59534	9705	" (under thread) Spring.....
59536	9707	" (upper thread) Spring.....
59537	9705	" (under thread) Spring Bushing (large).....
59537	9705	Tension (upper thread) Spring Bushing (large).....
59538	9705	Tension (under thread) Spring Bushing (small).....
59538	9705	Tension (upper thread) Spring Bushing (small).....
59539	----	Tension (under thread) Screw Stud 50326C with 51570C.....
59539	----	Tension (upper thread) Screw Stud 50326C with 51570C.....
83505	9711	Belt Guard (upper) Hinge Pin for 128173..
63824	9705	Tension (under thread) Releasing Lever Spring.....

No.	Plate	Name
67425	9707	Crank Connecting Rod Ball Screw Stud Nut Lock Washer.....
68164	9715	Thread (upper) Take-up Thread Retainer Spring for 138288.....
68350	9708	Arm Oil Cup (small) for oiling Arm Rock Shaft front, intermediate and back bearings and Hand Wheel and Pulley Shaft bearings.....
68350	9708	Oil Reservoir Oil Pipe Cup for 128496.....
120341	9724	Tweezers (curved) Accessories.....
120344	9724	Oiler (copper plated) with 120345 (Accessories).....
120345	9724	Oiler Spout 4 1/2 in. long for 120344.....
121266	9709	Lap Seam Feller on Slide for 121267.....
121267	----	" " " 121266 with 121268 and two 1443J.....
121268	9709	Lap Seam Feller Slide with 10165, for 121267.....
125564	9721	Thread (upper) Controller Lever with 50136F.....
125566	9706	Thread (upper) Controller Lever Hinge Stud
125567	9721	" " " " Post with 465C.....
125601	----	Cylinder Rock Shaft Connecting Rod End Bearing (upper) 55032 with two 171E, for 128026.....
126249	9725	Treadle for 150452.....
126250	9721	" Spring for 150452.....
128003	9720	Arm Rock Shaft Bushing (back).....
128006	9720	" " " Crank (back) with two 50083C for 128021.....
128015	9711	Cylinder Rock Shaft Bushing (back).....
128017	9720	" " " Crank with two 1253C..
128021	9718	Cylinder Rock Shaft Connecting Rod complete, Nos. 1722E, 1723E, 128022, 128025 and 128026.....
128022	----	Cylinder Rock Shaft Connecting Rod (rod only) for 128021.....
*128024	----	Cylinder Rock Shaft Connecting Rod End Bearing (lower) for 128025.....
128025	----	Cylinder Rock Shaft Connecting Rod Head (lower) Nos. 50730C, 128024 and two 171E for 128021.....
128026	----	Cylinder Rock Shaft Connecting Rod Head (upper) Nos. 217D, 50731C, 55034 and 125601, for 128021.....
128028	9706	Cylinder Thread Eyelet for 128139.....
128030	9720	" " Guard.....
128031	9722	" " Tube.....

No.	Plate	Name
128032	9719	Cylinder Top Cover (back) for 128449.....
128033	9719	" " " (front) with 233J and 128034, for 128449.....
128034	9719	Cylinder Top Cover (front) Spring for 128033.....
128043	9725	Feed Lifting Lever.....
128044	9706	" " " Hinge Pin.....
128050	9723	" Rod.....
128051	9711	" " Connecting Link (left).....
128052	9711	" " " " (right).....
128053	9720	" " Hinge Bracket with 50150C.....
128054	9718	" " " " Hinge Pin.....
128055	9706	" " " Pin.....
128059	9711	Looper (back) Carrier with 1454C.....
128061	9711	" (front) Carrier with 1454C.....
128063	9711	Needle Guard (front) for 1/4 in. gauge and below.....
128064	9720	Presser Bar (lower) Bushing.....
128065	9722	" " (upper).....
128066	9706	" " " Guide Bracket with 440C
128067	9720	" " Connecting Bracket with 448C and 453C.....
128068	9723	Presser Bar Lifter.....
128069	9723	" " " Connecting Link.....
128070	9722	" " Lifting Lever.....
128071	9723	" " " " Extension.....
128072	9723	" " Spring (flat).....
128075	9721	Tension (under thread) Bracket.....
128076	9705	" " " Releaser.....
128077	9722	" " " Releasing Lever....
128078	9705	" " " " Pin.....
128081	9707	Thread (under) Take-up Stripper Screw Washer.....
128082	9704	Tension (upper thread) Releasing Shaft Crank with 452C.....
128083	9723	Tension Releasing Arm with 5181B.....
128084	9722	" " " Connecting Rod.....
128094	9715	Thread (under) Separator (front) Thread Retainer (right) for 128166.....
128095	9715	Thread (under) Separator (front) Thread Guide for 128166.....
128100	9704	Thread (under) Take-up Thread Guard Bracket.....
128101	9711	Thread (under) Take-up Thread Guard Spring
128105	9721	" " " " Frame Cover Hinge Pin for 138281.....
128107	9706	Thread (upper) Controller Thread Guide....
128108	9721	" " " " " Post
128114	9715	" " " Take-up Stripper Bracket...



No.	Plate	Name
128128	9717	Cylinder End Cover Slide (back) 54625 with 54627 and 55165, for 128451.....
128139	----	Cylinder Thread Eyelet 128028 with 128166.
128166	----	Thread (under) Separator (front) with 128094,128095,128167 and two 726D, for 128139.....
128167	9715	Thread (under) Separator (front) Thread Retainer (left) for 128166.....
128171	9725	Belt Guard (lower) for 128173.....
128172	9725	" " (upper) for 128173.....
128173	----	Belt Guard complete, Nos. 331D,2273,63505, 128171,128172,743382 and three wood screws 1 in. No. 10.....
128329	----	Presser Foot Plate for 128330.....
128330	9704	Presser Foot (hinged) complete, for 1/8 in. to 3/16 in. gauges, Nos. 26276, 128329 and 128339.....
128339	----	Presser Foot Shank for 128330 and 128347..
128346	----	" " Plate for 128347.....
128347	9704	Presser Foot (hinged) complete, for 7/32 in. gauge and above, Nos.26276,128339 and 128346.....
128387	9720	Thread (under) Separator (back).....
128419	9708	Arm Rock Shaft Bushing (front) Oil Pad (braided cotton).....
*128430	----	Crank Connecting Rod End Bearing (upper) for 128432.....
*128432	----	Crank Connecting Rod Head (upper) Nos. 51043C,128430 and two 171E, for 128445.
*128439	----	Arm with 15404 and two 15405.....
128440	9708	" Oil Cup (large) for oiling Crank Connecting Rod (upper) Bearing and Cylinder Rock Shaft Connecting Rod (upper) Bearing.....
128441	9723	Arm Rock Shaft.....
128442	9720	" " " Bushing (front).....
128443	9720	" " " Crank (back) with two 50083C, for 128445.....
128444	9720	Arm Rock Shaft Crank (front) with two 50135C.....
128445	9718	Crank Connecting Rod complete, Nos. 217J, 1722E,1723E,54925,55034,128432,and 128448.....
*128447	----	Crank Connecting Rod End Bearing (lower) for 128448.....
*128448	----	Crank Connecting Rod Head (lower) Nos. 128447 and two 896E, for 128445 and.... 128483.....

No.	Plate	Name
*128449	----	Cylinder with 452C,460C,624C,50150C,54664, 128032,128033 and two 391J.....
128450	9717	Cylinder End Cover with 128456, for 128451
128451	----	Cylinder End Cover complete, Nos. 128128, 128450,128455 and three 1231J, for 128452.....
128452	----	Cylinder End Cover 128451 with 128453 and two 158J.....
128453	9717	Cylinder End Cover Extension for 128452...
128454	9717	" " " Lock Stud for 128455...
128455	----	" " " " 128454 with 337J and 128457, for 128451.....
*128456	----	Cylinder End Cover Lock Stud Housing for 128450.....
128457	9706	Cylinder End Cover Lock Stud Spring for 128455.....
128458	9718	Cylinder Rock Shaft for 128461.....
128459	9720	" " " Bushing (front).....
128460	9721	" " " Connection with 138308 and two each 152E and 175E, for 128461.
128461	----	Cylinder Rock Shaft Connection 128460 with 128458 and 128466, for 128484.....
*128464	----	Cylinder Rock Shaft Eccentric for 128466..
*128465	----	" " " " Body for 128466.....
128466	9720	Cylinder Rock Shaft Eccentric (adjustable) complete, Nos. 193E,7071,51145C,128464, 128465 and two 51426C, for 128461.....
128467	9717	Face Plate for 128468.....
128468	----	Face Plate complete, Nos. 621J,55184 and 128467.....
128469	9709	Feed Dog, 16 teeth (16 teeth to the inch) for 138289.....
128471	9709	Feed Dog, 16 teeth (16 teeth to the inch) for 138293.....
128472	9721	Feed Connecting Rod with two 896E, for 138302.....
*128474	----	Feed Eccentric for 128475.....
128475	9720	Feed Eccentric (adjustable) complete, Nos. 193E,7071,51145C,128474,128476,138306 and two 51426C, for 138302.....
*128476	----	Feed Eccentric Body for 128475.....
128477	9704	" Lifting Eccentric with 138308 and two 462C, for 128478.....
128478	----	Feed Lifting Eccentric 128477 with 128479, for 128484.....
128479	9721	Feed Lifting Lever Connecting Rod with two 896E, for 128478.....

No.	Plate	Name
128482	9718	Hand Wheel and Pulley Shaft with 138308, for 128483.....
128483	----	Hand Wheel and Pulley Shaft 128482 with 128448, for 128484.....
128484	----	Hand Wheel and Pulley Shaft 128483 with 128461, 128478 and 138302.....
128485	9704	Looper (back).....
128486	9704	" (front).....
128488	----	Needle Bar complete, Nos. 54708 and 128489
128489	9711	" Clamp with two 1498F, for 128488...
128490	9711	" Guard (back) for 1/4 in. gauge and below.....
128491	9719	Oil Reservoir for 128492.....
128492	----	" " " 128491 with 128493, 128494 and two 330J, for 138303.....
128493	9719	Oil Reservoir Cover for 128492.....
128494	9719	" " " Gasket for 128492.....
*128495	----	" " " Oil Pipe for 128496.....
128496	9722	" " " 128495 with 68350 and 128497, for filling oil reservoir, for 138303.....
*128497	----	Oil Reservoir Oil Pipe Head for 128496....
128498	9710	" " " Tube with 138269, for 128500.....
128499	9710	Oil Reservoir Oil Tube Wick for 128500....
128500	----	Oil Reservoir Oil Tube complete, for oiling Cylinder Rock Shaft Bushing (back) Nos. 51630,128498,128499 and 138268,for 138303.....
130869	9708	Arm Rock Shaft Bushing (back) Oil Pad (braided cotton).....
130869	9708	Arm Rock Shaft Bushing (intermediate) Oil Pad (braided cotton).....
131019	9722	Machine Base Oil Pipe for 138297.....
131020	9722	" " " " Oil Valve for 138297
132518	9716	" Cushion (small) felt for 138297...
138251	9710	Oil Reservoir Oil Tube with 138269, for 138253.....
138252	9710	Oil Reservoir Oil Tube Wick for 138253....
138253	----	Oil Reservoir Oil Tube complete, for oiling Cylinder Rock Shaft Connecting Rod (lower) Bearing Nos. 51630,138251, 138252 and 138268, for 138303.....
138254	9710	Oil Reservoir Oil Tube with 138269, for 138256.....
138255	9710	Oil Reservoir Oil Tube Wick for 138256....
138256	----	Oil Reservoir Oil Tube complete, for oiling Cylinder Rock Shaft Connection (front) Bearing Nos. 51630,138254, 138255 and 138268, for 138303.....

No.	Plate	Name
138257	9710	Oil Reservoir Oil Tube with 138269, for 138259.....
138258	9710	Oil Reservoir Oil Tube Wick for 138259 and 138264.....
138259	----	Oil Reservoir Oil Tube complete for oiling, Feed Connecting Rod, Nos. 51630, 138257 138258 and 138268, for 138303.....
138260	9708	Oil Reservoir Oil Tube with 138269, for 138262.....
138261	9708	Oil Reservoir Oil Tube Wick for 138262....
138262	----	Oil Reservoir Oil Tube complete, for oiling Cylinder Rock Shaft Connection (back) Bearing, Nos. 51630,138260, 138261 and 138268, for 138303.....
138263	9708	Oil Reservoir Oil Tube with 138269, for 138264.....
138264	----	Oil Reservoir Oil Tube complete, for oiling Feed Lifting Lever Connecting Rod, Nos. 51630,138258,138263 and 138268,for 138303.....
138265	9708	Oil Reservoir Oil Tube with 138269, for 138267.....
138266	9708	Oil Reservoir Oil Tube Wick for 138267....
138267	----	Oil Reservoir Oil Tube complete, for oiling Crank Connecting Rod (lower) Bearing, Nos. 51630,138265,138266 and 138268, for 138303.....
138268	9708	Oil Reservoir Oil Tube Coupling for 128500 138253,138256,138259,138262,138264 and 138267.....
*138269	----	Oil Reservoir Oil Tube Ferrule for 128498, 138251,138254,138257,138260,138263 and 138265.....
138270	9721	Tension (upper thread) Bracket.....
138271	9718	" " " Releasing Shaft....
*138272	----	Thread (under) Protector (left) for 138273
138273	9720	" " " " 138272 with 138300.....
*138274	----	Thread (under) Protector (right) for 138275.....
138275	9720	Thread (under) Protector (right) 138274 with 138300.....
138276	9720	Thread (under) Take-up with two 465C.....
138277	9721	" " " Stripper.....
138278	9711	" " " " Bracket...
138279	9721	" " " Thread Guard with 220J.....
138280	9719	Thread (under) Take-up Frame for 138281...

## NUMERICAL LIST OF PARTS

No.	Plate	Name
138281	----	Thread (under) Take-up Frame complete, Nos. 128105, 138280 and 138282.....
*138282	9719	Thread (under) Take-up Frame Cover with 501500, for 138281.....
138283	9706	Thread (upper) Controller.....
138284	9715	" " Take-up Bracket for 138288.
138285	9715	" " " Eyelet with 2084, for 138288.....
138286	9706	Thread (upper) Take-up Stripper.....
138287	9706	" " " Thread Retainer for 138288.....
138288	----	Thread (upper) Take-up complete, Nos. 1145H 68164, 138284, 138285 and 138287.....
138289	9709	Throat Plate for 1/8 in. to 5/32 in. gauges for 128469, for 138290.....
138290	----	Throat Plate 138289 with 138295 and two 228D.....
138293	9709	Throat Plate for 3/16 in. to 1/4 in. gauges for 128471, for 138294.....
138294	----	Throat Plate 138293 with 138295 and two 228D.....
138295	9709	Throat Plate Body and Lap Seam Feller Holder for 138290 and 138294.....
138296	9725	Machine Base for 138297.....
138297	----	Machine Base complete, Nos. 131019, 131020, 132618, 138296, three wood screws 2 in. No. 12 F.H. and four each 131F, 138298 and 138299.....
138298	9722	Machine Cushion (large) felt for 138297...
138299	9716	" " (small) felt for 138297...
138300	----	Thread (under) Protector Holder for 138273 and 138275.....
138302	----	Feed Connecting Rod 128472 with 128475, for 128484.....
138307	----	Oil Reservoir complete, Nos. 128492, 128496 128500, 138253, 138256, 138259, 138262, 138264 and 138267.....
138304	9708	Crank Connecting Rod Head (upper) Oil Pad (braided cotton).....
138304	9708	Cylinder Rock Shaft Connecting Rod Head (upper) Oil Pad (braided cotton).....
138306	9708	Feed Eccentric Lubricating Pad (wood) for 128475.....
138308	9706	Cylinder Rock Shaft Connection Lubricating Pad (wood) for 128460.....
138308	9706	Feed Lifting Eccentric Lubricating Pad (wood) for 128477.....
138308	9706	Hand Wheel and Pulley Shaft Lubricating Pad (wood) for 128482.....

## NUMERICAL LIST OF PARTS

No.	Plate	Name
138309	9725	Hand Wheel and Pulley with two 448C.....
138310	9717	" " " " Shaft Bushing (right) for 138311.....
138311	----	Hand Wheel and Pulley Shaft Bushing (right) 138310 with 138312 and 138316..
138312	9715	Hand Wheel and Pulley Shaft Bushing (right) Oil Pad (inside) wick for 138311.....
138312	9715	Hand Wheel and Pulley Shaft Flanged Bushing (left) Oil Pad (inside) wick for 138315.....
138313	9715	Hand Wheel and Pulley Shaft Flanged Bushing (left) Oil Pad (outside) wick for 138315.....
138314	9720	Hand Wheel and Pulley Shaft Flanged Bushing (left) for 138315.....
138315	----	Hand Wheel and Pulley Shaft Flanged Bushing (left) 138314 with 138312 and 138313.....
138316	9715	Hand Wheel and Pulley Shaft Bushing (right) Oil Pad (outside) wick for 138311.....
138317	9707	Tension (upper thread) Releasing Shaft Spring.....
138320	9708	Arm Oil Cup (small) Washer (leather) for 68350.....
*150057	----	Thread Unwinder Thread Separator for 150058.....
150058	9505	Thread Unwinder Thread Separator 150057 with 150059, for 150061.....
*150059	----	Thread Unwinder Thread Separator Bracket for 150058.....
150060	9505	Thread Unwinder Thread Separator Bracket Arm with 164J and 9525, for 150061.....
150061	----	Thread Unwinder Thread Separator complete, Nos. 164J, 9525, 150058 and 150060, for 150062.....
150062	9505	Thread Unwinder complete, for four spools, Nos. 150061, 201696J, 202490, 225324 225326, 225388, two 225257, three wood screws 7/8 in. No. 12 and four each 150203 and 225391.....
150203	9505	Thread Unwinder Spool Rest Cushion for 150062.....
150451	9725	Treadle Stand for 150452.....
150452	----	Treadle complete, Nos. 4879, 4882, 126249 126250, 150451 and two wood screws 1 in No. 16 F.H.....

## NUMERICAL LIST OF PARTS

No.	Plate	Name
200383C	9712	Thread Unwinder Spool Rest Rod Set Screw for 202490.....
201018C	9712	Thread Unwinder Spool Rest Set Screw for 225257.....
201696J	9707	Thread Unwinder Thread Guide Lock Nut for 150062.....
202490	9505	Thread Unwinder Spool Stand with 200383C, for 150062.....
225257	9505	Thread Unwinder Spool Rest (for two spools) with 201018C, for 150062.....
225322	9707	Thread Unwinder Thread Guide Rod Washer for 225324.....
225324	9505	Thread Unwinder Thread Guide Rod with 208E and 225322, for 150062.....
225326	9707	Thread Unwinder Thread Guide Position Cup for 150062.....
225388	9505	Thread Unwinder Spool Rest Rod for 150062.
225390	9724	" " Thread Cone Holder for in- verted cones, for 150062.....
225391	9505	Thread Unwinder Thread Guide for 150062...
743382	9704	Belt Guard (upper) Lock Spring for 128173.

Genuine Singer Needles should be used  
in Singer Machines.  
These Needles and their Containers  
are marked with the  
Company's Trade Mark "SIMANCO." 1

Needles in Containers marked  
"For Singer Machines"  
are not Singer made needles. 2

**ILLUSTRATIONS OF PARTS  
FOR  
MACHINE No. 148-12**

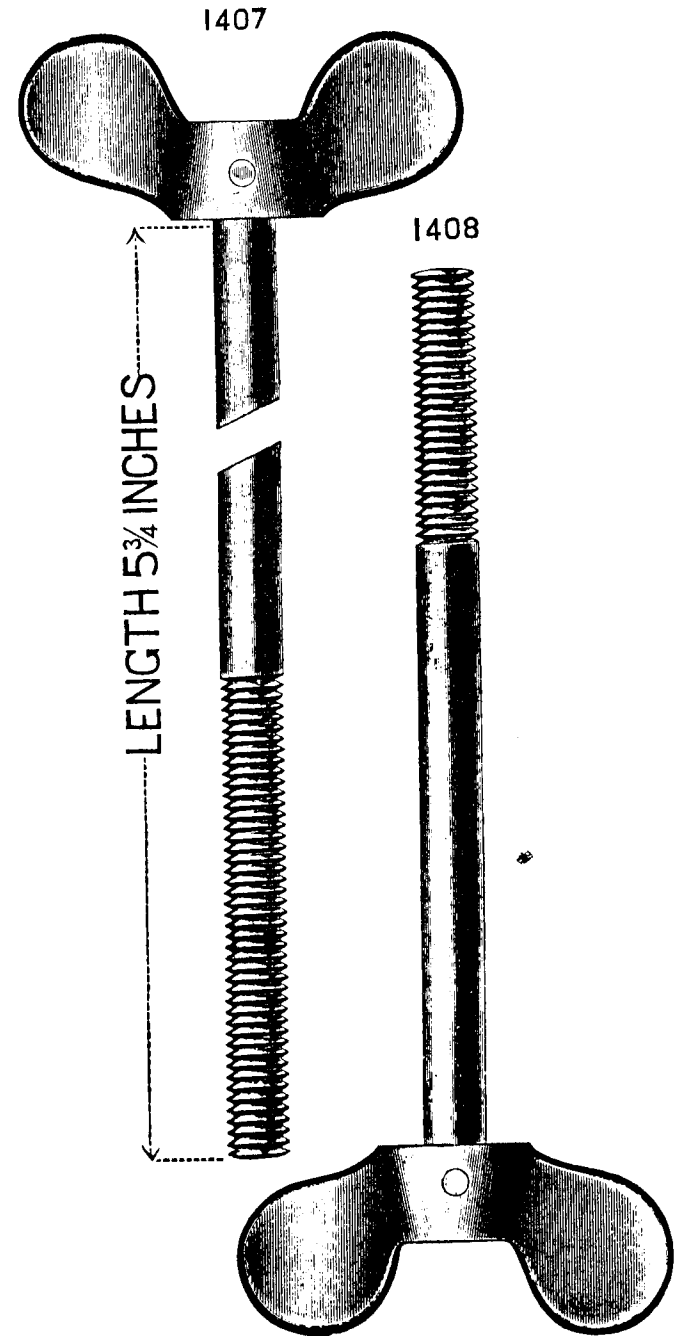


PLATE 9505—ONE-SIXTH SIZE

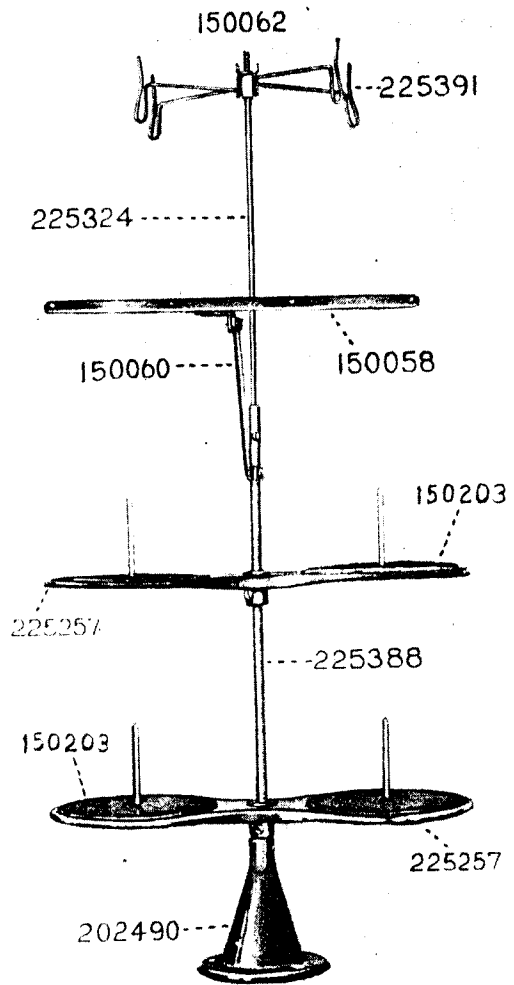


PLATE 9704—FULL SIZE

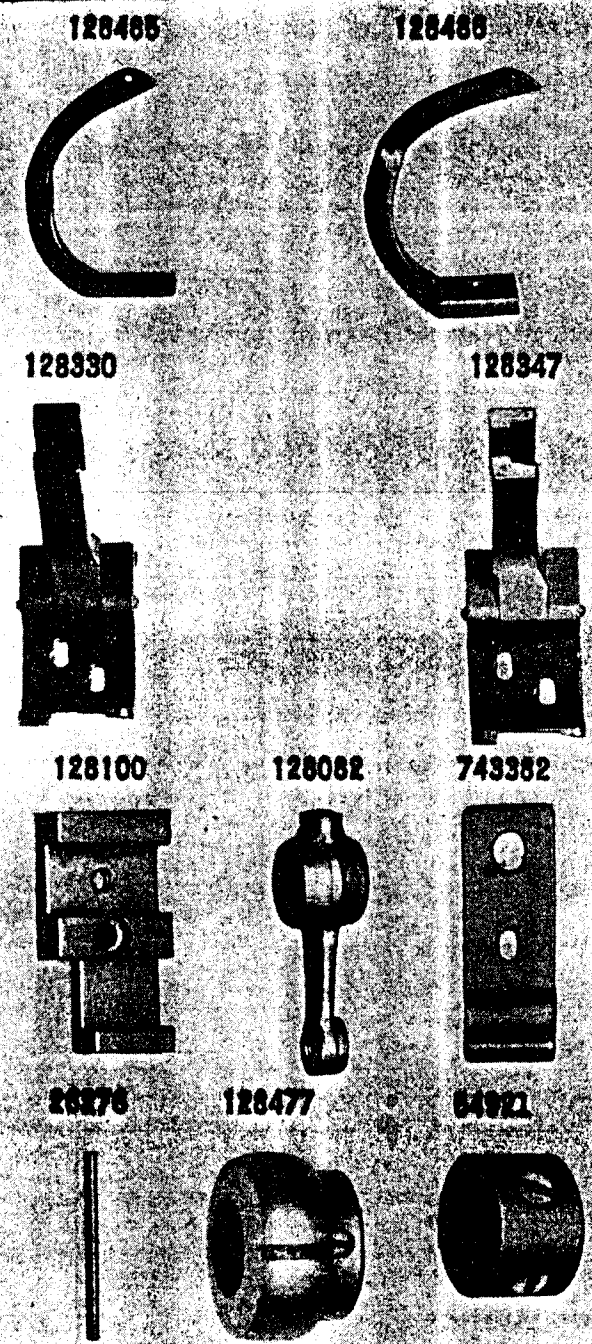


PLATE 9705--FULL SIZE

50328



63824



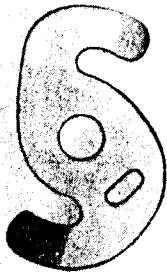
59534



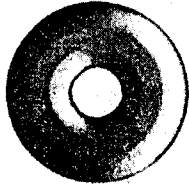
376



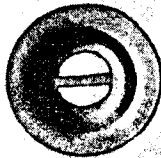
128076



2102



32572



59537



59538



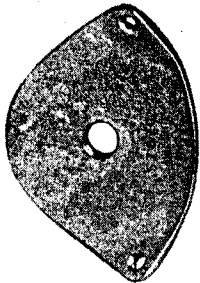
51570



50076



57076



128078



54988



46111



PLATE 9708--FULL SIZE

128044



128055



54664



128060



128107



138283



138286



138287



128066



128028



19294



128457



138308



2269



2049



54722



PLATE 9707—FULL SIZE

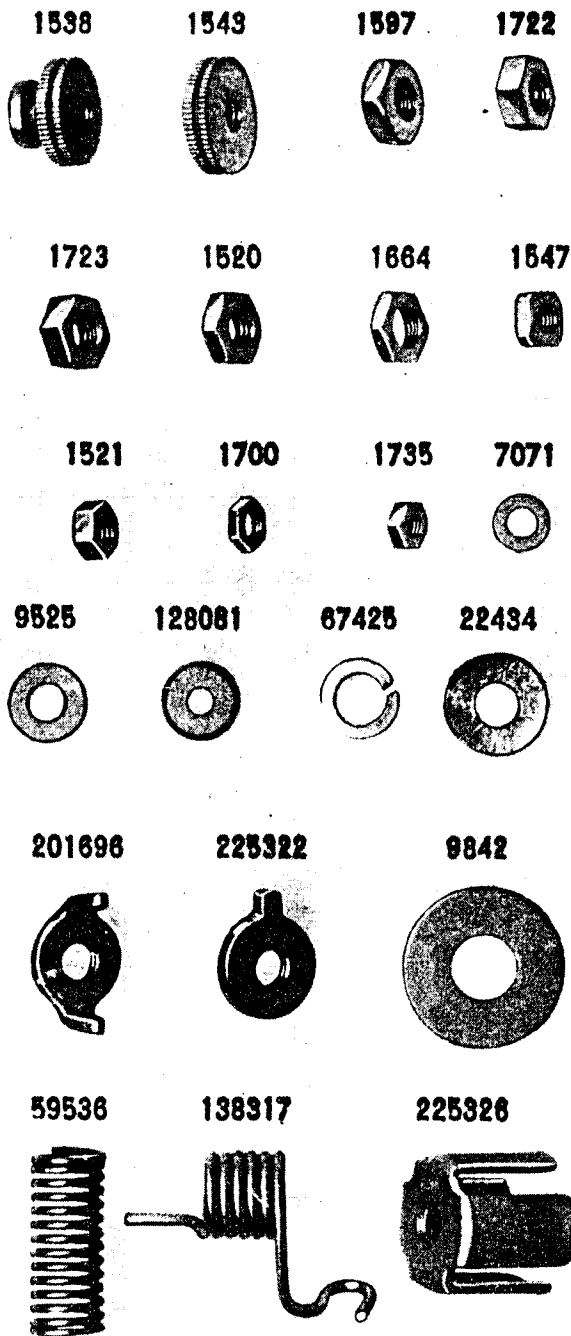


PLATE 9708—FULL SIZE

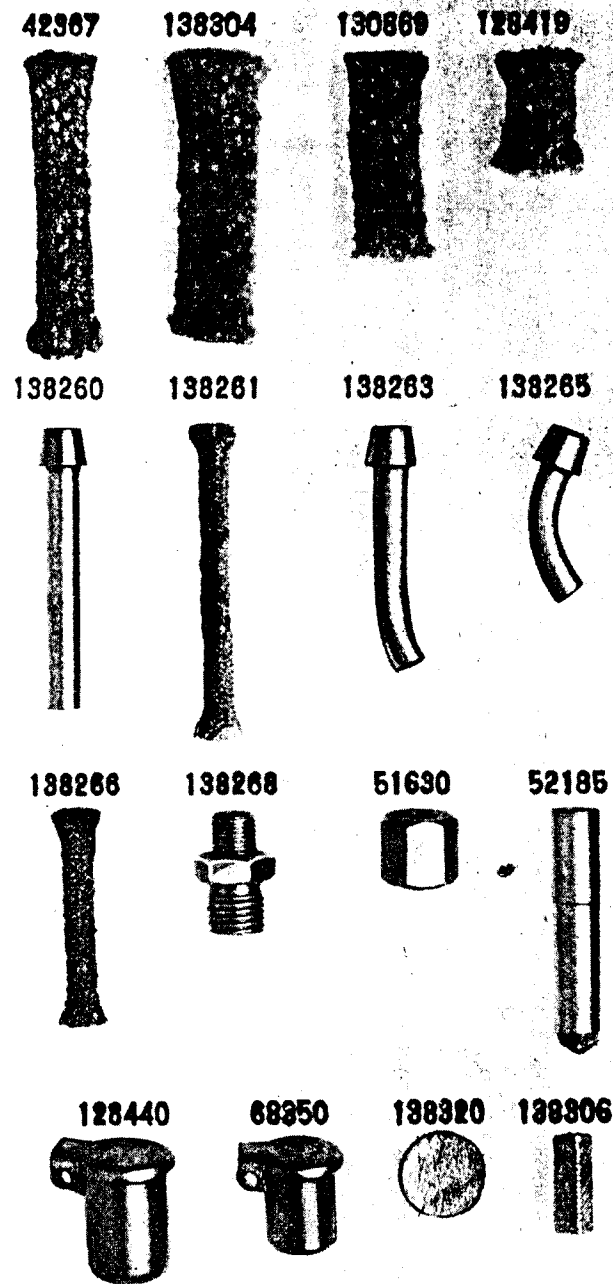


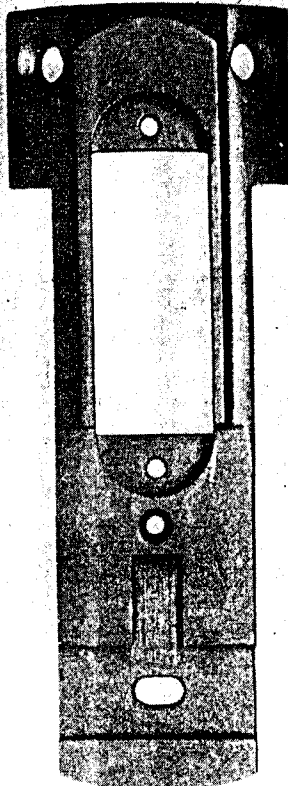


PLATE 9709—FULL SIZE

128469



138295



138289



128471



138293



50128



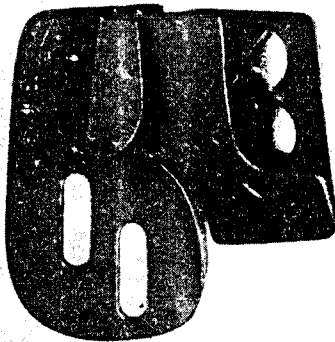
1319



228



121266



121268

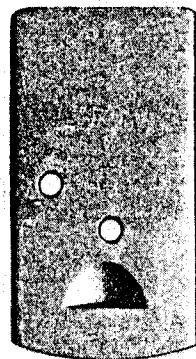


PLATE 9710—FULL SIZE

128498



128499



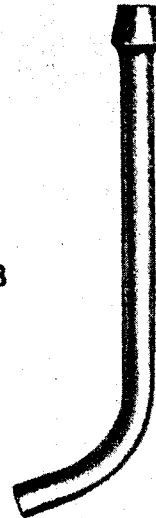
138251



138252



138254



138255



138257



138258



PLATE 9711—FULL SIZE

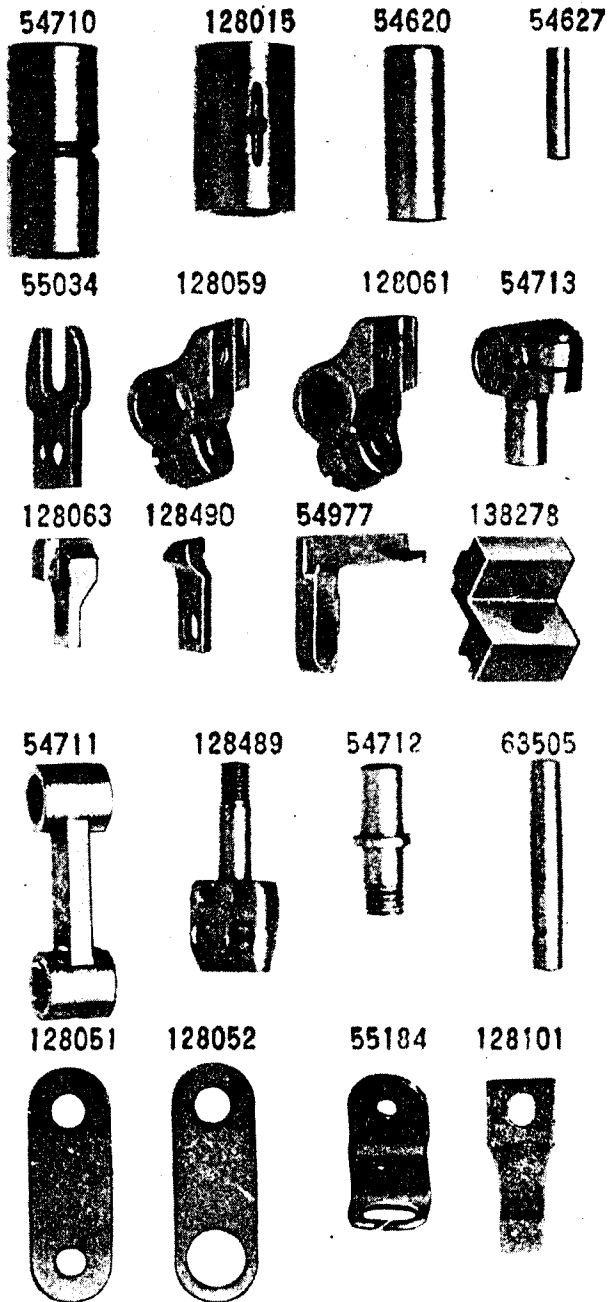


PLATE 9712—FULL SIZE

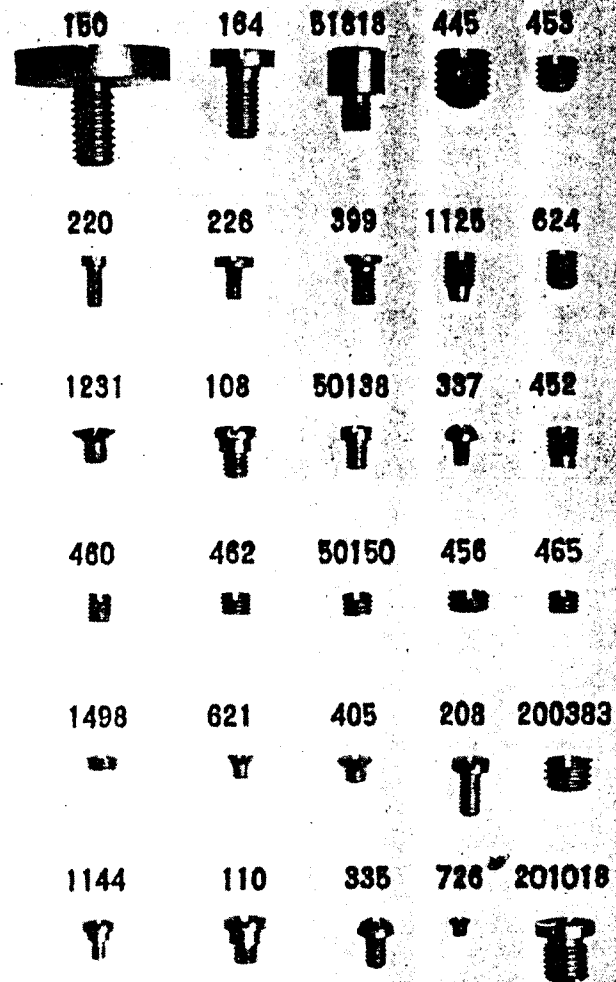
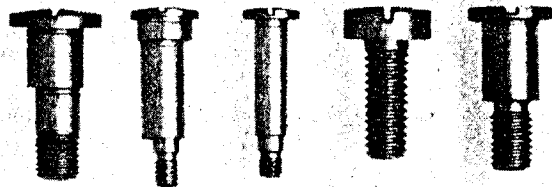
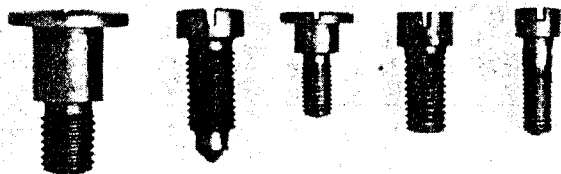


PLATE 9713—FULL SIZE

50997 50732 50733 134 1131



866 50195 50415 1149 896



158 171 178 181 50135



50083 51426 50999 175 1253



1492 217 1454 207 185

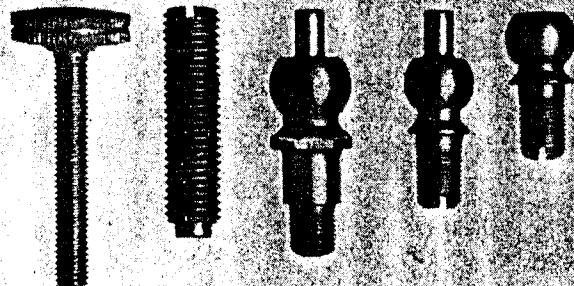


1443 50223 330 391 331



PLATE 9714—FULL SIZE

50132 50224 51043 50731 50730



51224 437 888 443 316



440 563 911 184 448



152 1364 1402 1302 233



193 999 51145 50116 1145



PLATE 9715--FULL SIZE

138316



138313



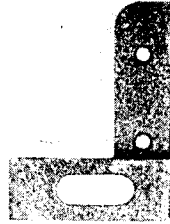
138312



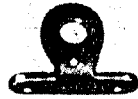
138284



128114



138285



128095



128167



128094



1137



2084



2273



10185



68164

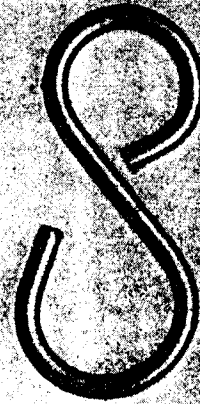


131

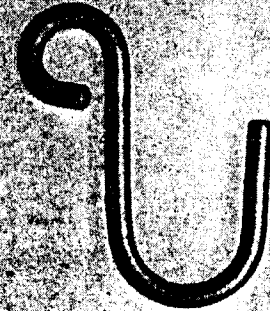


PLATE 9716--FULL SIZE

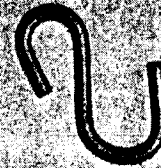
4879



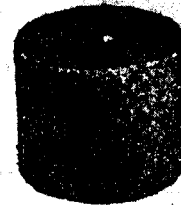
68864



56865



138289



132618

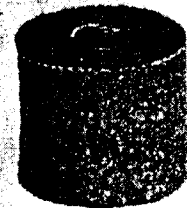


PLATE 9717-ONE-HALF SIZE

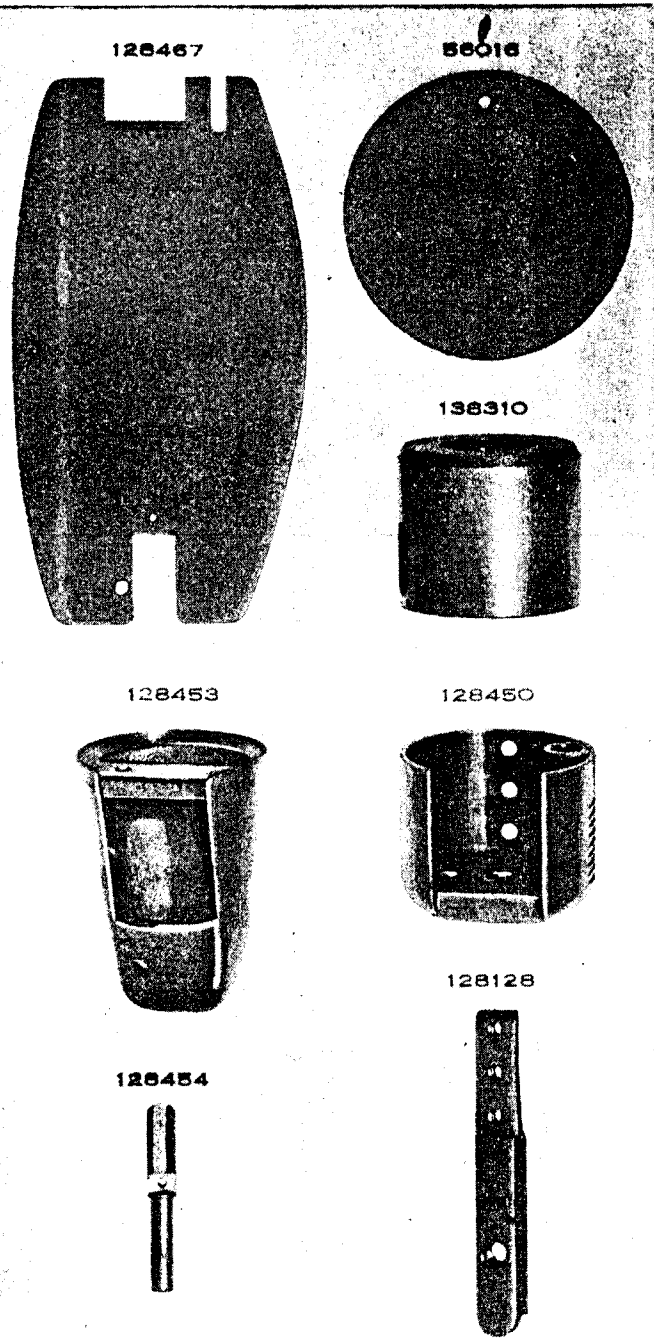


PLATE 9718-ONE-HALF SIZE

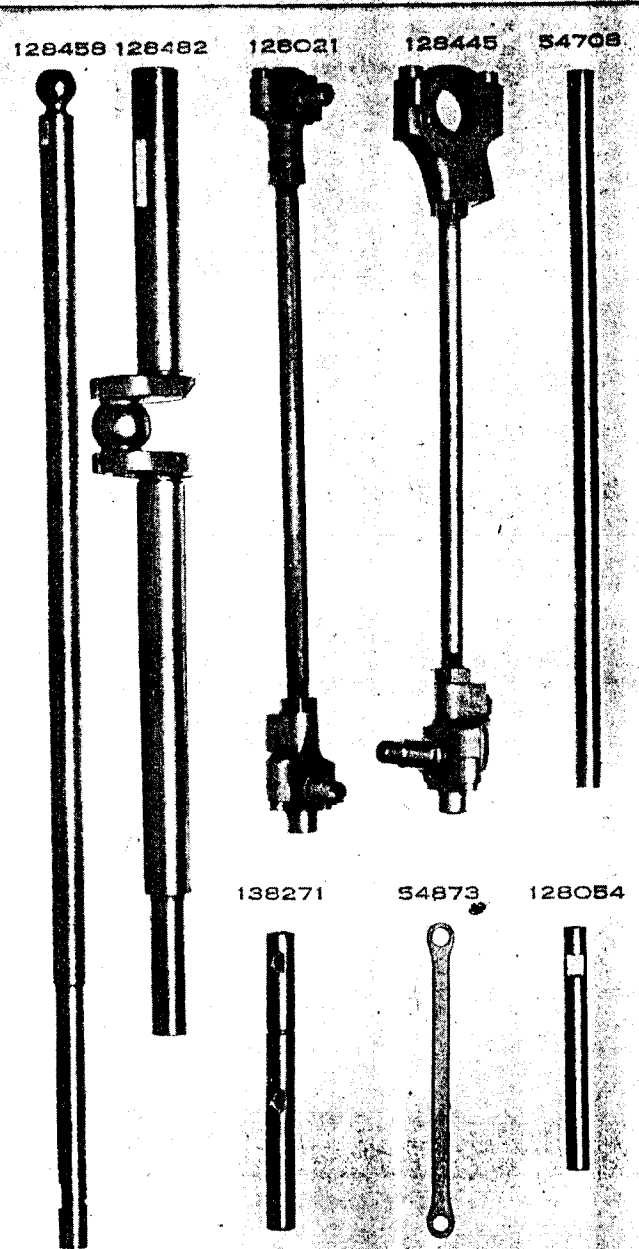
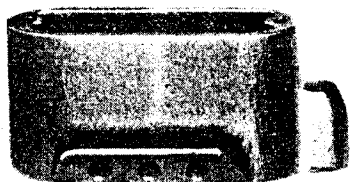
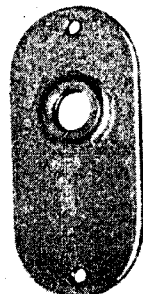


PLATE 9719—ONE-HALF SIZE

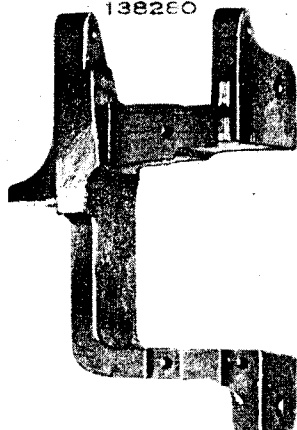
128491



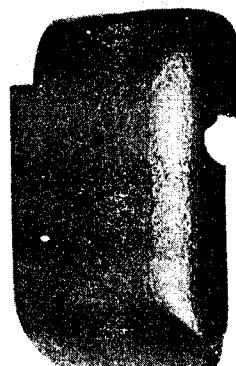
128493



138260

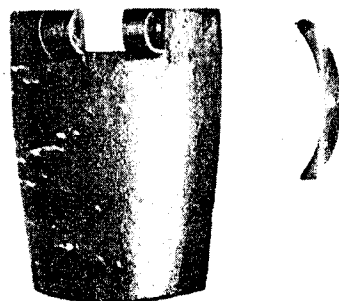


138282

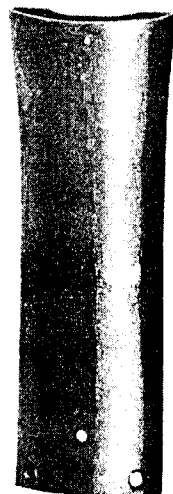


128032

128034



128033



128494

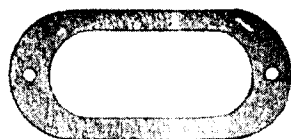


PLATE 9720—ONE-HALF SIZE

128466



128475



138314



128003



128442



54919



128444



128443



128006



128017



128459



128064



128067



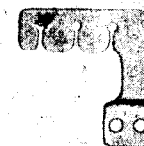
138273



138275



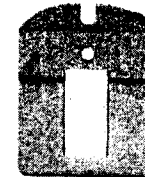
128387



128053



26277



138276



128030



PLATE 9721—ONE-HALF SIZE

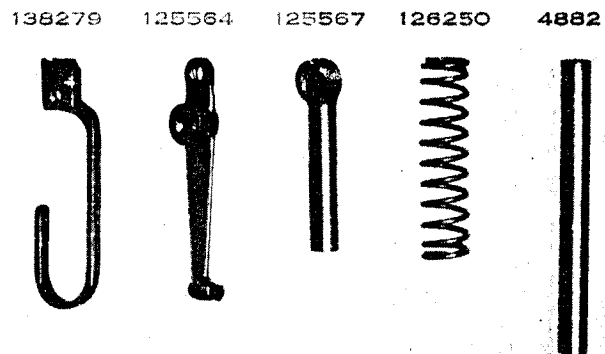
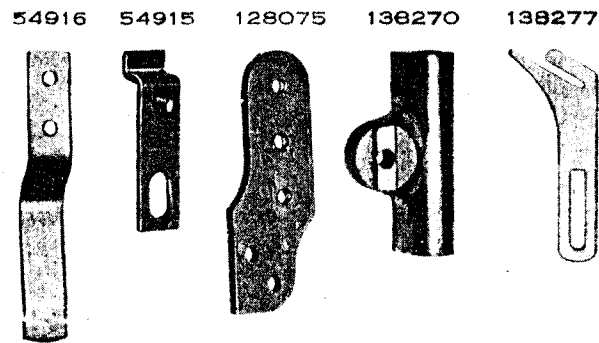
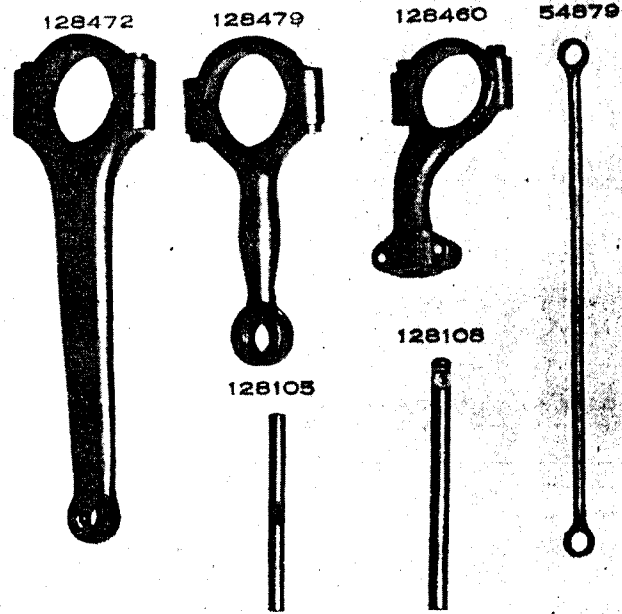


PLATE 9722—ONE-HALF SIZE

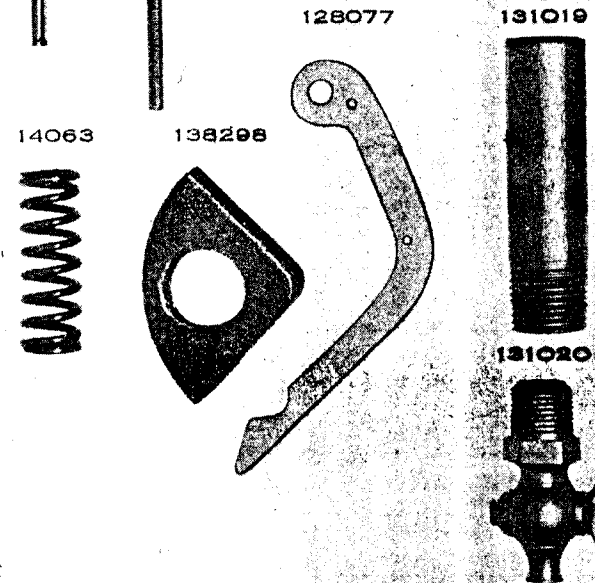
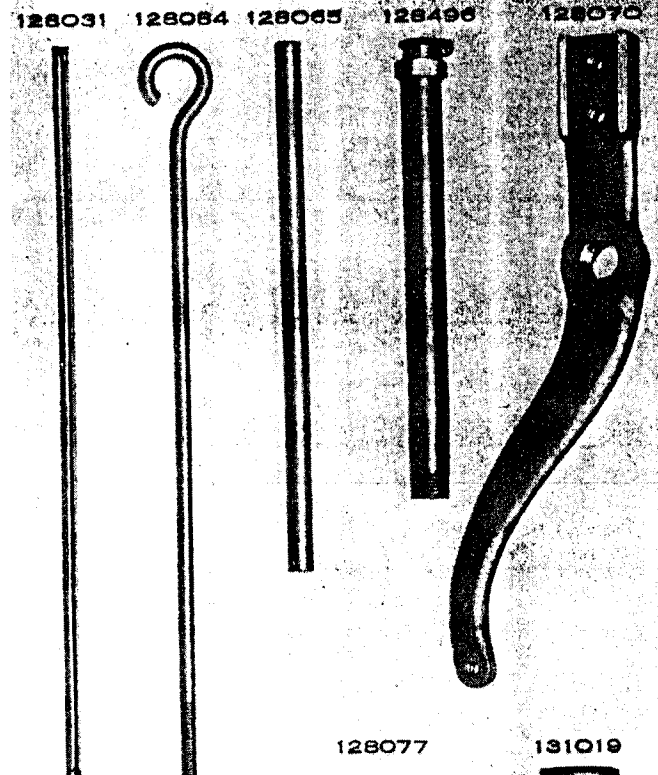
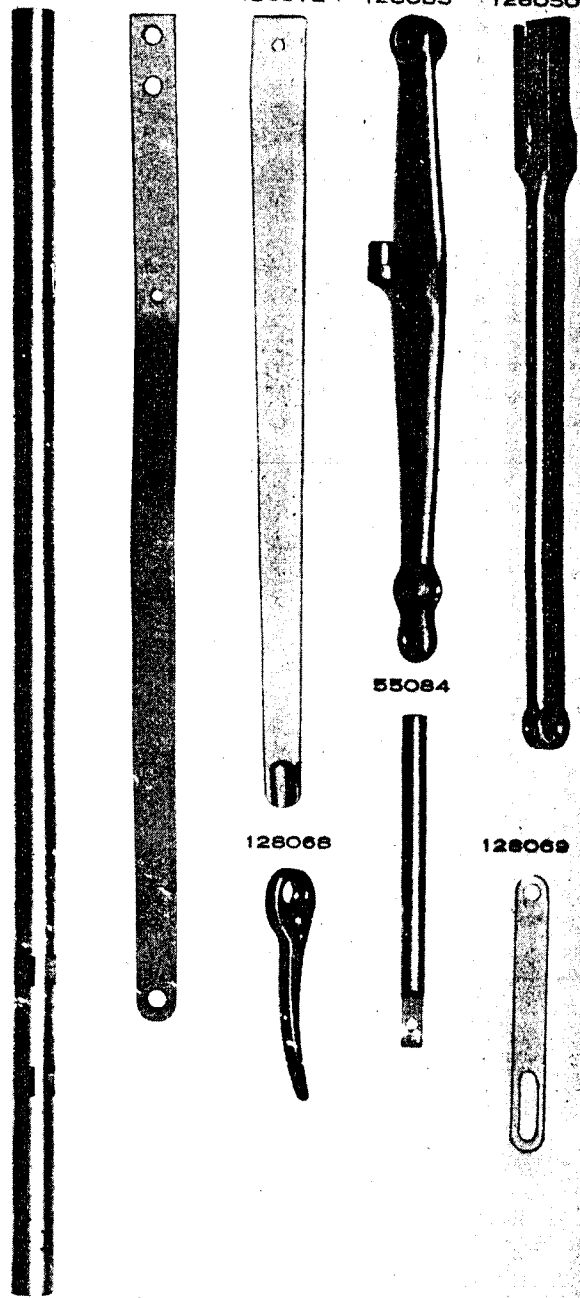


PLATE 9723—ONE-HALF SIZE

128441 128071 128072 128083 128050



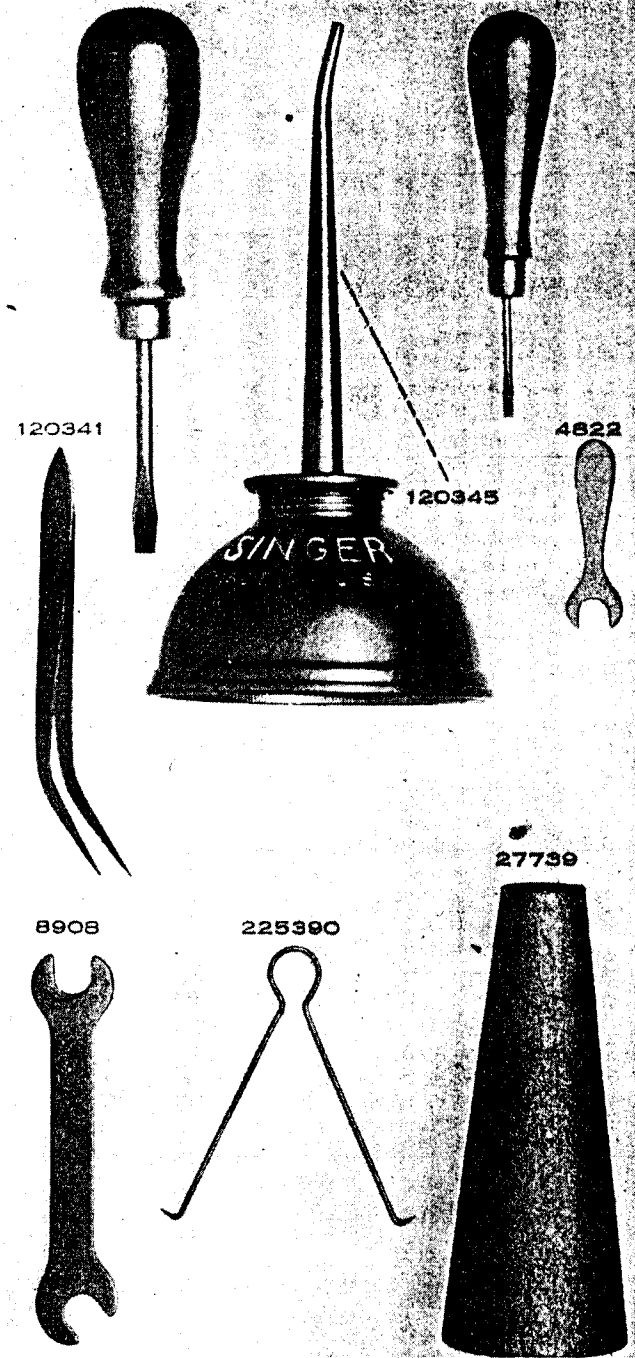
55084

128068

128069

PLATE 9724—ONE-HALF SIZE

26026 120344 26485



120341

4822

120345

27739

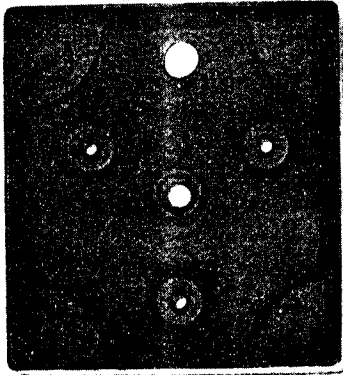
8908

225390

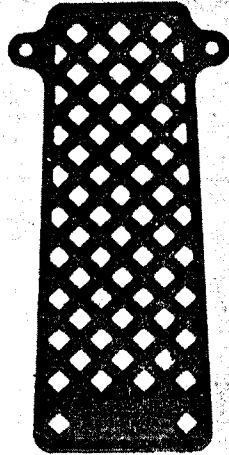


PLATE 9725—ONE-FOURTH SIZE

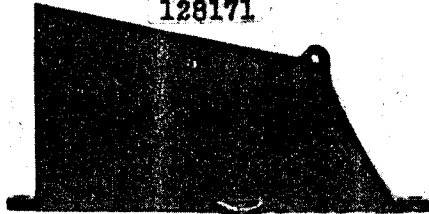
138296



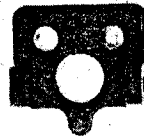
128249



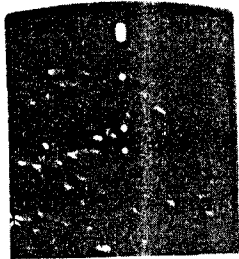
128171



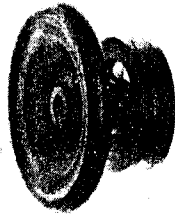
150451



54913



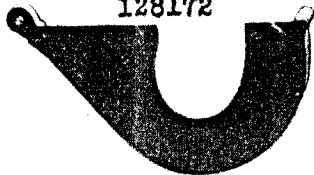
138309



128043



128172



Form 19368  
( 939 )  
Printed in U. S. A.

# LIST OF PARTS



MACHINES  
Nos. 231-7 and 231-8

---

THE SINGER MANUFACTURING COMPANY

## INSTRUCTIONS FOR OILING

Remove the oil gauge from the work supporting arm and pour oil into this arm until it is level with the mark on the gauge. Run the machine a few minutes, then check oil level, and if necessary, fill to mark on gauge.

Fill the oil reservoir at the right of the balance wheel.

Apply a few drops of oil to the three oil cups for the ball bearings.

When the machine is first started, put a few drops of oil in the top of the needle bar guide pin over the needle bar.

Thereafter, when the machine is in continuous use, replenish the oil supply about twice a week.

Use only "Singer Stainless Oil for High Speed Sewing Machines".

Copyright, U. S. A., 1939  
by The Singer Manufacturing Co.  
All Rights Reserved for all Countries

## INDEX

	Page
Accessories.....	19
Belt Guards.....	19
Foot Lifter and Starting Treadle Parts.....	19
Front Planks.....	21
Idlers.....	22
Lap Seam Fellers.....	23
Machine Cushions.....	23
Machine No. 231-7.....	5
Machine No. 231-8.....	18
Numerical List of Parts.....	25
Thread Unwinder.....	24
Thread Unwinder Spool Rests.....	24

# INSTRUCTIONS FOR ORDERING

In ordering from this list, use ONLY the part NUMBER in the FIRST column.

The number stamped on a Sewing Machine Part is in every case the number of the single part only.

Every combination of parts sent out as such has its specific number, which, although not stamped on the parts, must be used when ordering the combination.

Each number always indicates the SAME PART in whatever list it appears, or for whatever machine.

The letters after some of the numbers indicate the style of finish only, as follows:

- A-Hardened, Polished, Nickel Plated and Buffed
- B-Polished, Nickel Plated and Buffed
- C-Hardened Only
- D-Polished Only
- E-Soft, Not Polished
- F-Hardened and Polished
- F.J-Hardened, Polished and Nickel Plated
- G-Bright Rumbled and Nickel Plated
- H-Blued
- J-Nickel Plated Only
- K-Hardened and Nickel Plated
- L-Brass Plated
- M-Oxidized
- N-Japanned, Dull
- P-Japanned, Bright
- R-Merlized
- S-Cadmium Plating
- T-Copper Plated
- T.A-Hardened, Polished, Copper and Nickel Plated and Buffed
- T.B-Copper and Nickel Plated and Polished
- T.J-Copper and Nickel Plated Only
- T.K-Hardened, Copper and Nickel Plated
- T.L-Copper and Brass Plated
- T.M-Copper Plated and Oxidized
- U-Zinc Plated
- V-Silver Plated
- W-Polished and Nickel Plated
- X-Black Oxide, for Iron and Steel
- X.C-Hardened and Black Oxide, for Iron or Steel
- Y-Black Nickel Plated Only
- Z-Chromium Plated
- Z.A-Hardened, Polished, Nickel Plated, Buffed and Chromium Plated
- Z.B-Polished, Nickel Plated, Buffed and Chromium Plated
- Z.C-Hardened and Chromium Plated
- Z.J-Nickel and Chromium Plated

These letters MUST BE USED when they appear in the list; and AFTER the number as in the list.

In this series:

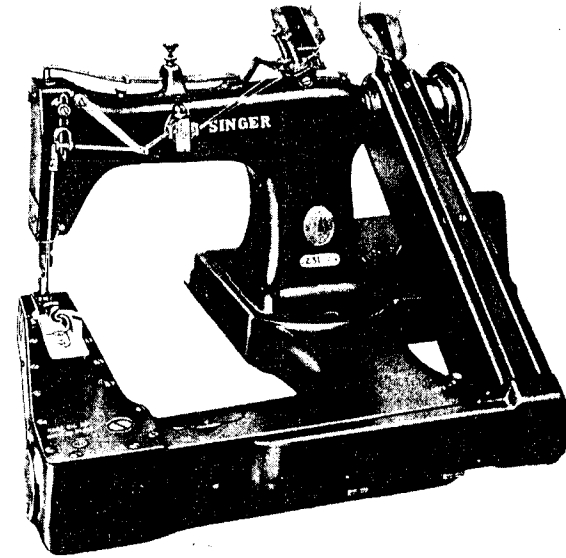
- 1 to 1500, 50001 to 51500 and 140001 to 142000 are Screw Numbers
- 1501 to 1800 and 51501 to 51800 are Nut Numbers
- 1801 to 2000 and 51801 to 52000 are Roller Numbers
- 2001 to 50000 and 52001 to 140000 and 142001 to 190000 are Sewing Machine Parts, 190001 and upward are numbers of Electrical Parts.

The figures in the second column refer only to the plates, illustrating the parts, and are NOT TO BE USED in ordering.

Parts marked with an asterisk (\*) are furnished only when repairs are made at factory.

When ordering parts which differ as to Gauge (the distance between seams) the Gauge, as well as the Number must be given on order.

## LIST OF PARTS COMPLETE FOR



### MACHINE No. 231-7

For Lap Seam Felling Work Shirts, Overalls, Trousers, etc., of medium weight materials. The machine has Two needles and two loopers. Feed off the arm two-thread chain-stitch. Range of gauges  $\frac{3}{16}$  inch to  $\frac{3}{8}$  inch, in steps of  $\frac{1}{32}$  inch. The standard gauges are  $\frac{3}{16}$  inch,  $\frac{1}{4}$  inch and  $\frac{5}{16}$  inch. Gauges in the range but not standard, can be furnished if required. Upper Thread Nipper and Slack Thread Controller. Drop Feed. Arm and bed rotary shafts are equipped with ball bearings. An oiling system automatically oils all the principal bearings and moving parts of the feed and looper mechanism. The needle bar driving mechanism is automatically oiled by an oil cup (sight feed) located on the balance wheel end of the arm rotary shaft. Needle bar stroke  $1 \frac{3}{16}$  inch. Length of stitch 6 to 18 to the inch. Speed 3800 R. P. M.

No.	Plate	Name
*139282	-----	Arm with 15404 and two 15405.....
8582	23078	" Dowel Pin.....
11119	23076	" Oil Tube with 52045 (for oiling Tension Needle Thread Nipper).....

No.	Plate	Name
52045	23076	Arm Oil Tube Packing (wick).....
139283	23076	" Rotary Shaft.....
139284	-----	" " " 139283 with 139228 and 139308.....
150483	23076	Arm Rotary Shaft Ball Bearing (back)....
139003	23076	" " " " " " Case
139004	23076	" " " " " " " "
		Nut.....
50422C	23076	Arm Rotary Shaft Ball Bearing (back) Case Set Screw.....
68350	23076	Arm Rotary Shaft Ball Bearing (back) Oil Cup.....
131319	23076	Arm Rotary Shaft Ball Bearing (back) Oil Cup Oil Pad (braided cotton).....
139005	23076	Arm Rotary Shaft Ball Bearing (back) Spacing Collar.....
139006	23076	Arm Rotary Shaft Ball Bearing (front)...
68350	23076	" " " " " " Oil Cup.....
131319	23076	Arm Rotary Shaft Ball Bearing (front) Oil Cup Oil Pad (braided cotton)....
139007	23076	Arm Rotary Shaft Ball Bearing (front) Oil Retainer (back).....
139008	23076	Arm Rotary Shaft Ball Bearing (front) Oil Retainer (front).....
139199	23076	Arm Rotary Shaft Crank with two each 1036C and 1149C.....
139228	-----	Arm Rotary Shaft Crank 139199 with 139103.....
1149C	23076	Arm Rotary Shaft Crank Set Screw.....
51185F	23076	" " " Screw.....
139010	23076	" " " Sprocket Wheel with two each 201254C and 202253.....
201254C	23076	Arm Rotary Shaft Sprocket Wheel Set Screw.....
202253	23076	Arm Rotary Shaft Sprocket Wheel Spring Flange.....
116E	23078	Arm Screw.....
139011	23076	Balance Wheel, 2 in. pulley, with two 51283C.....
51283C	23076	Balance Wheel Set Screw.....
*139249	-----	Bed.....
139251	23079	Bed Cover with 139253 and two 50411E....
139252	23079	" " Gasket (cork).....
139253	23079	" " " Clamping Plate.....
50411E	23079	" " " " " Screw...
50608R	23079	" " Hole Plug Screw.....
139017	23079	" " " " " Washer.....
50004C	23079	" " Screw.....
139337	23078	" Extension.....

No.	Plate	Name
783E	23078	Bed Extension Screw.....
50608R	23076	" Oil Drain Plug Screw.....
139017	23076	" " " " " Washer.....
139022	23079	" " Gauge.....
139025	23076	" Rotary Shaft.....
139026	23076	" " " Ball Bearing (intermedi- ate).....
139028	23076	Bed Rotary Shaft Ball Bearing (inter- mediate) Sleeve with two 462C.....
462C	23076	Bed Rotary Shaft Ball Bearing (inter- mediate) Sleeve Set Screw.....
132231	23076	Bed Rotary Shaft Ball Bearing (left)....
139030	23076	" " " " " " Cover
139031	23076	" " " " " " " "
		Gasket.....
202R	23076	Bed Rotary Shaft Ball Bearing (left) Cover Screw.....
150483	23076	Bed Rotary Shaft Ball Bearing (right)...
139032	23076	" " " " " " Case
139004	23076	" " " " " " " "
		Nut.....
50422C	23076	Bed Rotary Shaft Ball Bearing (right) Case Set Screw.....
68350	23076	Bed Rotary Shaft Ball Bearing (right) Oil Cup.....
131319	23076	Bed Rotary Shaft Ball Bearing (right) Oil Cup Oil Pad (braided cotton)....
139033	23076	Bed Rotary Shaft Ball Bearing (right) Spacing Collar.....
249311	23076	Bed Rotary Shaft Belt.....
139034	23078	" " " " " Guard with two 200363C.....
139035	23078	Bed Rotary Shaft Belt Guard Cover.....
139036	23078	" " " " " " 139035 with 139037.....
139037	23078	Bed Rotary Shaft Belt Guard Cover Gasket (cork).....
200092F	23078	Bed Rotary Shaft Belt Guard Cover Screw.
200363C	23078	" " " " " Set Screw...
1480D	23076	" " " Screw (left).....
50040D	23076	" " " " (right).....
139038	23076	" " " Sprocket Wheel with 202253 and two 201254C.....
201254C	23076	Bed Rotary Shaft Sprocket Wheel Set Screw.....
202253	23076	Bed Rotary Shaft Sprocket Wheel Spring Flange.....
139039	23080	Face Plate (lower half).....
139040	23080	" " " " Gasket (cork)...
391C	23080	" " " " Screw.....

No.	Plate	Name
139041	23080	Face Plate (upper half).....
29234	23080	" " " " Position Plate..
1053E	23080	" " " " " " " "
		Screw.....
51224W	23080	Face Plate (upper half) Thumb Screw....
139043	23080	Feed Bar.....
139256	23080	" " Hinge Pin (eccentric).....
443C	23080	" " " " Set Screw.....
1520J	23080	" " " " " " Lock Nut...
139046	23080	" " " " Slide Block.....
139388	23082	Feed Dog with row of teeth between the needles, 16 teeth (12 teeth to the inch) for 3/16 in. and 7/32 in. gauges, for 139389, for Work Shirts.
139049	23083	Feed Dog with row of teeth between the needles, 19 teeth (14 teeth to the inch) for 1/4 in. to 3/8 in. gauges, for 139186, for Work Shirts.....
139382	23083	Feed Dog with row of teeth between the needles, 14 teeth (10 teeth to the inch) for 1/4 in. to 3/8 in. gauges, for 139385, for Light Weight Over- alls.....
139414	23084	Feed Dog with row of teeth between the needles, 11 teeth (8 teeth to the inch) for 1/4 in. to 3/8 in. gauges, for 139385, for Heavy Weight Over- alls.....
139415	23084	Feed Dog with row of teeth between the needles, 17 teeth (12 teeth to the inch) for 1/4 in. to 3/8 in. gauges, for 139385, for Light Weight Over- alls.....
1255E	23082	Feed Dog Screw.....
51061C	23080	" Eccentric Body Set Screw.....
7071	23080	" " Clamping Washer.....
217J	23080	" " " " Screw....
139052	23080	Feed Eccentric (adjustable) complete, Nos. 217J, 7071, 50328C and two 51061C.....
139053	23080	Feed Eccentric Slide Block.....
139054	23080	" Lifting Eccentric Forked Connection
157J	23080	" " " " " "
		Screw.....
139055	23080	Feed Lifting Eccentric Forked Connection Slide Block.....
50328C	23080	Feed Regulating Screw.....

No.	Plate	Name	
139056	23082	Looper (back).....	
		Note: When ordering Loopers, state gauge required.	
139057	23082	Looper (front).....	
139058	23080	" Avoiding Eccentric with two 50150C.....	
139059	23080	Looper Avoiding Eccentric Forked Connec- tion.....	
139060	23080	Looper Avoiding Eccentric Forked Connec- tion Bracket with 456C.....	
	122E	23080	Looper Avoiding Eccentric Forked Connec- tion Bracket Screw.....
139257	23080	Looper Avoiding Eccentric Forked Connec- tion Crank (forked) with 1324C.....	
	1324C	23080	Looper Avoiding Eccentric Forked Connec- tion Crank Clamping Screw.....
139055	23080	Looper Avoiding Eccentric Forked Connec- tion Slide Block.....	
50150C	23080	Looper Avoiding Eccentric Set Screw....	
51485E	23080	" Clamping Screw.....	
139062	23080	" Driving Arm with 1047C.....	
139063	-----	" " " 139062 with 139066 and 139070.....	
139064	23080	Looper Driving Arm Connecting Link.....	
139065	23080	" " " " " Hinge Pin.....	
	1047C	23080	Looper Driving Arm Connecting Link Hinge Pin Set Screw.....
139066	23080	Looper Driving Arm Connection with four 175E.....	
	175E	23080	Looper Driving Arm Connection Cap (low- er) Screw.....
	175E	23080	Looper Driving Arm Connection Cap (upper) Screw.....
139069	23080	Looper Driving Arm Connection Crank with 1057E.....	
139070	23080	Looper Driving Arm Connection Crank Ball Screw Stud.....	
	1520J	23080	Looper Driving Arm Connection Crank Ball Screw Stud Nut.....
128551	23080	Looper Driving Arm Connection Crank Ball Screw Stud Nut Lock Washer.....	
	1057E	23080	Looper Driving Arm Connection Crank Clamping Screw.....
139352	23080	Looper Driving Arm Hinge Stud.....	
443C	23080	" " " " " Set Screw.	
139072	23080	" Eccentric and Feed Lifting Eccen- tric with two 1259C.....	
	1259C	23080	Looper Eccentric and Feed Lifting Eccen- tric Set Screw.....
139073	23080	Looper Eccentric Connection with 1047C..	

No.	Plate	Name
139074	23080	Looper Eccentric Connection Slide Block.
139075	23080	" " " " " "
		Screw Stud.....
139076	23080	Looper Eccentric Connection Slide Block
		Screw Stud Collar with two 1253C....
1253C	23080	Looper Eccentric Connection Slide Block
		Screw Stud Collar Set Screw.....
456C	23080	Looper Eccentric Connection Slide Block
		Screw Stud Set Screw.....
139411	23080	Looper Eccentric Connection Slide Block
		Screw Stud Washer (leather).....
139262	23079	Looper Gate (left) for Throat Plates 3/4
		in. wide.....
139264	23083	Looper Gate (left) for Throat Plates 7/8
		in. wide.....
139269	23079	Looper Gate (right) for Throat Plates
		3/4 in. wide.....
139271	23083	Looper Gate (right) for Throat Plates
		7/8 in. wide.....
139272	23079	Looper Gate Retaining Spring.....
190J	23079	" " " " Screw.....
139093	23080	" Holder with 172E, 26276 and 51485E
172E	23080	" " Clamping Screw.....
139094	23080	" " Shaft.....
139095	23080	" " " Bushing (back).....
435C	23080	" " " " " Set
		Screw.....
139096	23080	Looper Holder Shaft Bushing (front)....
435C	23080	" " " " " Set
		Screw.....
139097	23080	Looper Holder Shaft Collar with 1454E...
1454E	23080	" " " " Clamping Screw
26276	23080	" Position Pin.....
139273	23080	" Thread Guide.....
206J	23080	" " " Screw.....
139099	23080	Needle Bar (hollow).....
139100	----	Needle Bar complete, Nos. 139099 and
		139116.....
139101	23080	Needle Bar Bushing (lower).....
1133E	23080	" " " " Set Screw....
139102	23080	" " Connecting Link.....
139103	----	" " " " 139102 with
		139105 and 139108.....
139105	23076	Needle Bar Connecting Link Hinge Stud...
139239	23076	" " " " " " Oil
		Pad (braided cotton).....
1036C	23076	Needle Bar Connecting Link Hinge Stud
		Set Screw.....

No.	Plate	Name
139229	23080	Needle Bar Connecting Link Spacing Wash- er (thickness .004", .008" or .012")
		Note: When ordering No. 139229, state thickness re- quired.
139108	23080	Needle Bar Connecting Stud with 175E....
175E	23080	" " " " Clamping Screw
139110	23080	" " " " Oil Pad (wick)
139111	23080	" " " " Slide Block...
139112	23080	" " " " " "
		Guide.....
1057C	23080	Needle Bar Connecting Stud Slide Block
		Guide Screw.....
59456	23080	Needle Bar Connecting Stud Slide Block
		Guide Screw Washer.....
139113	23080	Needle Bar Guide.....
52146	23080	" " " Oil Pad (inside) braided cotton.....
139114	23080	Needle Bar Guide Oil Pad (outside) felt.
1133E	23080	" " " Set Screw.....
139115	23080	" " Thread Guide.....
330W	23080	" " " " Screw.....
59019	23080	" " " " Washer....
139116	23080	" Clamp with two 1498F.....
139117	23080	" Guard, for 3/32 in. to 3/16 in. gauges.....
139118	23082	Needle Guard, for 7/32 in. to 9/32 in. gauges.....
139119	23083	Needle Guard, for 5/16 in. gauge.....
139195	23083	" " " 11/32 in. to 3/8 in. gauges.....
		Note: When ordering Needle Guards, state gauge re- quired.
139120	23080	Needle Guard Holder.....
453C	23080	" " " Set Screw.....
1167E	23080	" " Screw.....
1498F	23080	" Set Screw.....
139121	23076	Oil Cup Body.....
139122	23076	" " " Cap (transparent).....
139123	23076	" " " " Gasket (cork).....
139124	23076	" " " " Retainer.....
131C	23076	" " " " Screw.....
50617B	23076	" " " Oil Plug Screw.....
139125	23076	" " " " " Washer.....
139126	23076	Oil Cup complete, for oiling Needle Bar Connecting Link, Nos. 50617B, 139121 to 139125 and four 131C.....
139127	23076	Oil Cup Gasket (soft leather).....
139128	23080	Presser Bar with 25303.....
25303	23080	" " Ball, size 1/4 in.....
139410	23080	" " Bushing (lower).....

No.	Plate	Name
1133E	23080	Presser Bar Bushing (lower) Set Screw...
38456	23080	" " " (upper).....
1133E	23080	" " " " Set Screw...
139130	23080	" " Lifting Bracket with 1057E..
1057E	23080	" " " " Clamping Screw
139131	23085	" " " " Lifter.....
807D	23085	" " " " " Hinge Screw.....
139132	23085	Presser Bar Lifting Lever.....
802D	23085	" " " " Hinge Screw...
139133	23085	" " " " Spring.....
131198	23085	" " Spring (auxiliary).....
38467	23085	" " " (flat).....
38468	23085	" " " Stud.....
139218	23082	" Foot Plate.....
139219	23082	" " " Hinge Stud.....
665J	23082	" " " " Position Screw.....
139220	23082	Presser Foot Shank.....
139221	23082	" " Yielding Heel.....
139222	23082	" " " " Connection...
18055	23082	" " " " " Hinge Pin.....
9610	23082	Presser Foot Yielding Heel Connection Spring.....
18055	23082	Presser Foot Yielding Heel Hinge Pin....
139223	23082	Presser Foot (triple hinged) complete for 3/16 in. to 1/4 in. gauges, Nos. 9610, 139218, 139220 to 139222 and two each 665J, 18055 and 139219.....
139383	23083	Presser Foot Plate.....
128390	23083	" " " Hinge Stud.....
665J	23083	" " " " " Position Screw.....
131705	23083	Presser Foot Shank.....
131706	23083	" " Yielding Heel.....
131707	23083	" " " " Connection...
18055	23083	" " " " " Hinge Pin.....
131534	23083	Presser Foot Yielding Heel Connection Spring.....
18055	23083	Presser Foot Yielding Heel Hinge Pin....
139420	23083	Presser Foot (triple hinged) complete, for 1/4 in. to 3/8 in. gauges, for overall work and shirt work, Nos. 131534, 131705 to 131707, 139383 and two each 665J, 18055 and 128390.
Note: When ordering Presser Feet, state gauge re- quired.		
190J	23082	Presser Foot Screw.....
574W	23085	Pressure Regulating Thumb Screw.....

No.	Plate	Name
1539W	23085	Pressure Regulating Thumb Screw Lock Nut
139390	23085	Slack Thread Regulator.....
139300	23085	" " " " Connecting Link Connecting Stud with 453C.....
453C	23085	Slack Thread Regulator Connecting Link Connecting Stud Set Screw.....
139299	23085	Slack Thread Regulator Holder.....
131405	23085	" " " " Crank with 171E.....
1423J	23085	Slack Thread Regulator Holder Crank Cap Screw.....
171E	23085	Slack Thread Regulator Holder Crank Clamping Screw.....
131406	23085	Slack Thread Regulator Holder Crank Con- necting Link.....
217J	23085	Slack Thread Regulator Screw.....
139275	23085	Tension (looper thread) Body and Thread Guide with 42727.....
430C	23085	Tension (looper thread) Body Set Screw..
51486C	23085	" " " Regulating Screw
1423J	23085	" " " " " " Cap Screw.....
139140	23085	Tension (looper thread) Regulating Screw Nut with 42639.....
42639	23085	Tension (looper thread) Regulating Screw Nut Position Pin.....
59534	23085	Tension (looper thread) Spring.....
139276	23085	" " " Tension Plate...
42727	23085	" " " " " Po- sition Pin.....
139278	23085	Tension (looper thread) complete, Nos. 1423J, 51486C, 59534, 139140, 139275 and three 139276.....
54070	23085	Tension (needle thread) Bracket.....
376J	23085	" " " " Screw...
2102	23085	" " " Disc.....
139307	23085	" " " Nipper Body and Thread Guide with 13538.....
1149C	23085	Tension (needle thread) Nipper Body Set Screw.....
139308	23076	Tension (needle thread) Nipper Cam with two 456C.....
456C	23076	Tension (needle thread) Nipper Cam Set Screw.....
139309	23085	Tension (needle thread) Nipper Stud....
139310	----	" " " " " 139309 with 5684 and 139311.....
13218	23085	Tension (needle thread) Nipper Stud Spring.....
139311	23085	Tension (needle thread) Nipper Stud Wearing Sleeve.....



No.	Plate	Name
5684	23085	Tension (needle thread) Nipper Stud Wearing Sleeve Pin.....
1698R	23085	Tension (needle thread) Nipper Stud Nut.
59456	23085	" " " " " Washer
139276	23085	" " " " Tension Plate.....
13538	23085	Tension (needle thread) Nipper Tension Plate Position Pin.....
139373	23085	Tension (needle thread) Nipper complete, Nos. 1698R,13218,59456,139307,139310 and three 139276.....
51570C	23085	Tension (needle thread) Regulating Thumb Nut.....
32572	23085	Tension (needle thread) Releasing Disc..
54988	23085	" " " " Pin...
54071	23085	" " " " Shaft.
54872	23085	" " " " " Crank with 624C.....
139143	23085	Tension (needle thread) Releasing Shaft Crank Connecting Link.....
110C	23085	Tension (needle thread) Releasing Shaft Crank Connecting Link Hinge Screw...
624C	23085	Tension (needle thread) Releasing Shaft Crank Set Screw.....
316C	23085	Tension (needle thread) Releasing Shaft Stop Screw.....
1547J	23085	Tension (needle thread) Releasing Shaft Stop Screw Nut.....
50326C	23085	Tension (needle thread) Screw Stud.....
59539	-----	" " " " " 50326C with 51570C.....
131741	23085	Tension (needle thread) Spring.....
59537	23085	" " " " Bushing (large).....
59538	23085	Tension (needle thread) Spring Bushing (small).....
131696	23085	Tension (needle thread) Thread Guide (double).....
139144	23076	Thread (looper) Take-up with two 1266C..
139145	23076	" " " " Cover.....
139146	23076	" " " " Hinge Pin.
139147	23076	" " " " Lock Spring
51282J	23076	" " " " " " Screw.....
1250C	23076	Thread (looper) Take-up Cover Position Screw Stud.....
1266C	23076	Thread (looper) Take-up Set Screw.....
139148	23076	" " " " Stripper.....
139149	23076	" " " " Plate..
139279	23076	" " " " " Bracket.....

No.	Plate	Name
139280	23076	Thread (looper) Take-up Stripper Plate Bracket 139279 with 219J, 237J,240J, 7071,51282J,139145 to 139149,139152 to 139157 and two each 203J, 207J, 665J and 17022.....
175E	23076	Thread (looper) Take-up Stripper Plate Bracket Screw.....
207J	23076	Thread (looper) Take-up Stripper Plate Screw.....
139152	23076	Thread (looper) Take-up Stripper Plate Thread Guard.....
665J	23076	Thread (looper) Take-up Stripper Plate Thread Guard Screw.....
203J	23076	Thread (looper) Take-up Stripper Screw..
17022	23076	" " " " " Washer.....
139153	23076	Thread (looper) Take-up Thread Guard (fiberglass).....
139154	23076	Thread (looper) Take-up Thread Guide (left).....
237J	23076	Thread (looper) Take-up Thread Guide (left) Screw.....
139155	23076	Thread (looper) Take-up Thread Guide (right).....
219J	23076	Thread (looper) Take-up Thread Guide (right) Screw.....
7071	23076	Thread (looper) Take-up Thread Guide (right) Screw Washer.....
139156	23076	Thread (looper) Take-up Thread Separator
139157	23076	" " " " " Thread Retainer.....
240J	23076	Thread (looper) Take-up Thread Separator Thread Retainer Screw.....
139158	23085	Thread (looper) Thread Guide (left)....
229J	23085	" " " " " Screw
139158	23085	" " " " " (right)....
229J	23085	" " " " " Screw
139159	23085	" " " " " Bracket....
176J	23085	" " " " " Screw
139160	23085	" " " " " Sup-port.....
202J	23085	Thread (looper) Thread Guide Bracket Support Screw (lower).....
237J	23085	Thread (looper) Thread Guide Bracket Support Screw (upper).....
139162	23085	Thread (looper) Thread Tube (belt guard) Bushing.....
203J	23085	Thread (looper) Thread Tube (belt guard) Seat Screw.....
139164	23085	Thread (looper) Thread Tube (belt guard) with four 139162.....

No.	Plate	Name
139167	23085	Thread (looper) Thread Tube (front of bed) Bushing.....
139168	23085	Thread (looper) Thread Tube (front of bed) with 18191 and four 139167.....
139169	23085	Thread (looper) Thread Tube (front of bed) Cover.....
139170	23085	Thread (looper) Thread Tube (front of bed) Cover 139169 with 139171 and two 229J.....
139171	23085	Thread (looper) Thread Tube (front of bed) Cover Catch.....
229J	23085	Thread (looper) Thread Tube (front of bed) Cover Catch Screw.....
139172	23085	Thread (looper) Thread Tube (front of bed) Cover Hinge Plate.....
176J	23085	Thread (looper) Thread Tube (front of bed) Cover Hinge Plate Screw.....
12162	23085	Thread (looper) Thread Tube (front of bed) Cover Hinge Pin.....
139173	23085	Thread (looper) Thread Tube (front of bed) Cover Lock Spring.....
18191	23085	Thread (looper) Thread Tube (front of bed) Cover Lock Spring Position Pin.
139174	23085	Thread (looper) Thread Tube (front of bed) Cover Lock Spring Reinforcing Plate.....
202J	23085	Thread (looper) Thread Tube (front of bed) Cover Lock Spring Screw.....
139281	23080	Thread (looper) Thread Tube (side of bed).....
139177	23085	Thread (needle) Eyelet.....
207J	23085	" " " Screw.....
139391	23085	" " Take-up with 202E.....
202E	23085	" " " Clamping Screw..
54095	23085	" " " Plate.....
68164	23085	" " " " Spring....
1449J	23085	" " " " " Screw
139392	23085	Thread (needle) Take-up complete, Nos. 1449J, 54095, 68164 and 139391.....
139393	23085	Thread (needle) Take-up (auxiliary)....
131496	23085	" " " " " Clamp
997J	23085	" " " " " " Screw.....
139158	23085	Thread (needle) Thread Guide (left)....
229J	23085	" " " " " " Screw
139158	23085	" " " " " (right)....
229J	23085	" " " " " " Screw
139180	23085	" " " " " Bracket....
139416	23080	" Cutter (knife).....
139417	23080	" " " " Guard.....

No.	Plate	Name
50318W	23080	Thread Cutter Screw.....
139186	23083	Throat Plate, for 1/4 in. to 3/8 in. gauges, for 139049.....
139385	23083	Throat Plate, for 1/4 in. to 3/8 in. gauges, for 139382, 139414 and 139415
139389	23082	Throat Plate, for 3/16 in. and 7/32 in. gauges, for 139388.....
Note: When ordering Throat Plates, state gauge required.		
691F	23082	Throat Plate Screw.....
*15404	-----	Trade Mark.....
15405	-----	" " Rivet.....

Genuine Singer Needles should be used in Singer Machines.  
These Needles and their Containers are marked with the Company's Trade Mark "SIMANCO." 1

Needles in Containers marked "For Singer Machines" are not Singer made needles. 2

LIST OF PARTS COMPLETE  
FOR  
**MACHINE No. 231-8**

For Lap Seam Felling Work Shirts, Overalls, Trousers, etc., of medium and medium heavy weight materials. The machine has Two needles and two loopers. Feed off the arm two-thread chain-stitch. Range of gauges  $\frac{3}{16}$  inch to  $\frac{3}{8}$  inch, in steps of  $\frac{1}{32}$  inch. The standard gauges are  $\frac{3}{16}$  inch,  $\frac{1}{4}$  inch and  $\frac{5}{16}$  inch. Gauges in the range but not standard, can be furnished if required. Upper Thread Nipper and Slack Thread Controller. Drop Feed. Arm and bed rotary shafts are equipped with ball bearings. An oiling system automatically oils all the principal bearings and moving parts of the feed and looper mechanism. The needle bar driving mechanism is automatically oiled by an oil cup (sight feed) located on the balance wheel end of the arm rotary shaft. Needle bar stroke  $1\frac{5}{16}$  inch. Length of stitch 6 to 18 to the inch. Speed 3600 R. P. M.

NOTE: THIS MACHINE IS THE SAME AS THE 231-7 MACHINE WITH THE FOLLOWING EXCEPTIONS:

No.	Plate	Name
139374	-----	Arm Rotary Shaft 139283 with 139308 and 139376, in place of 139284.....
139375	23077	Arm Rotary Shaft Crank with 1036C, 1259C and two 1149C, in place of 139199...
139376	-----	Arm Rotary Shaft Crank 139375 with 139103, in place of 139228.....
139418	23077	Balance Wheel, 3 in. pulley, with two 51283C, in place of 139011.....
139377	23081	Needle Bar (hollow) in place of 139099..
139373	-----	Needle Bar complete, Nos. 139116 and 139377, in place of 139100.....
139379	23081	Needle Bar Bushing (lower) in place of 139101.....
1259C	23077	Needle Bar Connecting Link Hinge Stud Set Screw (short).....
139412	23081	Needle Bar Guide, in place of 139113....

## ACCESSORIES

No.	Plate	Name
120344	23086	Oiler (copper plated) with 120345.....
120345	23086	" Spout, 4 1/2 in. long.....
120440	23086	Screw Driver (large).....
121108	23086	" " (small).....
120341	23086	Tweezers (curved).....
23535	23086	Wrench.....

## BELT GUARDS

No.	Plate	Name
139398	23087	Belt Guard with two 146R, for use with Individual Motors and Low Shaft Power Table.....
139217	23087	Belt Guard with two wood screws $\frac{3}{4}$ in. No. 9 R.H., for use with Singer Universal Safety Power Table.....
152004	23087	Belt Guard with two wood screws 1 in. No. 10 R.H.M.F.O. and A. for Series S 39 S 49, S 59 and S 69 Electric Transmitters.....
146R	23087	Belt Guard Screw.....

## FOOT LIFTER AND STARTING TREADLE PARTS\*

FOR INDIVIDUAL MOTORS

No.	Plate	Name
6439	23088	Foot Lifter Chain, 36 in. to 45 in. with 56864 and 56865.....
Note: When ordering No. 6439, state length required.		
4879	23088	Foot Lifter Chain Connecting Link.....
56864	23088	" " " Hook (large).....
56865	23088	" " " " (small).....
150212	23088	" " Treadle.....
150487	23088	Starting Treadle with two 140215C.....
140215C	23088	" " Set Screw.....
150488	23088	" " Shaft.....
150489	23088	" " " Arm with two 140215C.....

## FOOT LIFTER AND STARTING TREADLE PARTS

No.	Plate	Name
140215C	23088	Starting Treadle Shaft Arm Set Screw....
46681	-----	" " " Bracket.....
60502	23088	" " " " 46681 with two wood screws 1 in. No. 14.....
150216	23088	Starting Treadle Shaft Collar with two 445C.....
445C	23088	Starting Treadle Shaft Collar Set Screw.
150490	23088	" " Spacing Collar.....
150491	-----	Starting and Foot Lifter Treadle com- plete, Nos. 4879,6439,150212,150216, 150487 to 150490 and two 60502.....

## FOOT LIFTER AND STARTING TREADLE PARTS

## FOR UNIVERSAL SAFETY POWER TABLE

No.	Plate	Name
67819	23088	Treadle Pitman Rod (lower).....
67820	23088	" " " (upper).....
80223	23088	" " " Clamp with 361C.....
361C	23088	" " " Set Screw.....
150208	23088	" " " Spring.....
2762	23088	" " " Collar with 362C.....
362C	23088	Treadle Pitman Rod Spring Collar Set Screw.....
23250	23088	Treadle Pitman Rod Spring Washer.....
126684	23088	Treadle Pitman Rod complete, Nos. 2762, 67819,67820,80223 and two each 23250 and 150208.....
150497	23088	Starting and Foot Lifter Treadle with Pitman complete, Nos. 126684 and 150491.....

## FOOT LIFTER AND STARTING TREADLE PARTS

## FOR LOW SHAFT POWER TABLE

## FOR UNDER DRIVER NO. 150499

No.	Plate	Name
27639	23089	Treadle Pitman Rod.....
80223	23089	" " " Clamp with 361C.....

## FOOT LIFTER AND STARTING TREADLE PARTS

No.	Plate	Name
361C	23089	Treadle Pitman Rod Clamp Set Screw.....
60626	23089	Treadle Pitman Rod complete, Nos. 80223 and two 27639.....
150498	23089	Starting and Foot Lifter Treadle with Pitman complete, Nos. 60626 and 150491.....

## FRONT PLANKS

No.	Plate	Name
135060	-----	Front Plank, 1 5/8 in. thick, 19 in. wide, 46 1/2 in. long, for Series 1500, 1900 and 2900 Motors, for Uni- versal Electric Transmitter Tables..
135061	-----	Front Plank, 1 5/8 in. thick, 19 in. wide, 48 in. long, for Series 1500, 1900 and 2900 Motors, for Electric Transmitter Tables (cast iron legs)
135062	-----	Front Plank, 1 5/8 in. thick, 19 in. wide, 46 1/2 in. long, for Series 1700 Motors, for Universal Electric Transmitter Tables.....
135063	-----	Front Plank, 1 5/8 in. thick, 19 in. wide, 48 in. long, for Series 1700 Motors, for Electric Transmitter Tables (cast iron legs).....
135064	-----	Front Plank, 1 5/8 in. thick, 19 in. wide, 46 1/2 in. long, for Series S 39, S 49, S 59 and S 69 Electric Transmitters, for Universal Electric Transmitter Tables.....
135065	-----	Front Plank, 1 5/8 in. thick, 19 in. wide, 48 in. long, for Series S 39, S 49, S 59 and S 69 Electric Trans- mitters, for Electric Transmitter Tables (cast iron legs).....
135098	-----	Front Plank, 1 5/8 in. thick, 19 in. wide, 46 1/2 in. long, for Universal Safety Power Table.....
135068	-----	Front Plank, 1 5/8 in. thick, 19 in. wide, 46 1/2 in. long, for Universal Low Shaft Power Table.....
135069	-----	Front Plank, 1 5/8 in. thick, 19 in. wide, 48 in. long, for Old Style Low Shaft Power Table.....

**IDLERS**  
**IDLER**  
(ADJACENT TO BALANCE WHEEL)

No.	Plate	Name
150480	23090	Bracket with 1448C.....
150481	23090	Pulley.....
150482	23090	" Shaft.....
150483	23090	" " Ball Bearing.....
150484	23090	" " " " Cover.....
150485	23090	" " " " " Gasket (cork).....
330R	23090	Pulley Shaft Ball Bearing Cover Screw...
144D	23090	" " Cap Screw.....
130328	23090	" " Oil Cup.....
1448C	23090	" " Set Screw.....
150496	23090	Pulley and Shaft complete, Nos. 144D, 150481 to 150485 and four 330R.....
150486	23090	Idler complete, Nos. 130328, 150480, 150496 and two 51183R.....
51183R	23090	Idler Screw.....

**IDLER**  
FOR UNDER THE TABLE  
FOR SINGER UNIVERSAL SAFETY POWER TABLE

No.	Plate	Name
150528	23090	Idler Base with 356C.....
150481	23090	" Pulley.....
150482	23090	" " Shaft.....
150483	23090	" " " Ball Bearing.....
150484	23090	" " " " " Cover...
150485	23090	" " " " " " Gas- ket (cork).....
330R	23090	Idler Pulley Shaft Ball Bearing Cover Screw.....
150529	23090	Idler Pulley Shaft Bracket (lower) with 168C and 692C.....
692C	23090	Idler Pulley Shaft Bracket (lower) Clamping Screw.....

No.	Plate	Name
150530	23090	Idler Pulley Shaft Bracket (upper) with 168C and 692C.....
692C	23090	Idler Pulley Shaft Bracket (upper) Clamping Screw.....
150531	23090	Idler Pulley Shaft Bracket Shaft.....
356C	23090	" " " " " Set Screw
144D	23090	" " " Cap Screw.....
168C	23090	" " " Set Screw.....
150496	23090	Idler Pulley and Shaft complete, Nos. 144D, 150481 to 150485 and four 330R
150532	23090	Idler complete, Nos. 150528 to 150531, two 150496 and three wood screws 1 1/4 in. No. 12 F.H.....
150533	23090	Idler Guard with two wood screws 3/4 in. No. 9 R.H., for 150532.....

**LAP SEAM FELLERS**

No.	Plate	Name
121628	23091	Lap Seam Feller (adjustable) on Shank, for medium heavy and heavy weight material.....
121629	23091	Lap Seam Feller on Shank with Yielding Lower Scroll, for medium heavy and heavy weight material.....
121449	23091	Lap Seam Feller Clamping Plate.....
1443B	23091	" " " Screw.....
139366	23091	" " " Slide.....

**MACHINE CUSHIONS**

No.	Plate	Name
139190	23086	Machine Cushion (round rubber).....
139191	23086	" Mounting Cushion (moulded rubber)
51069R	23086	" " " Bolt with 51581R
51581R	23086	" " " " Nut.....
2807	23086	" " " " " Washer.
146R	23086	" Screw, for mounting machine to table.....

## THREAD UNWINDER

### FOR FOUR CONES

No.	Plate	Name
150364	23092	Base with two 437C.....
150365	23092	Rod.....
437C	23092	" Set Screw.....
150366	23092	Thread Cone Holder.....
164J	23092	" " " Screw.....
19020	23092	" " " " Washer.....
150367	23092	" " " Support.....
51082R	23092	" " " " Screw with 51581R.....
51581R	-----	Thread Cone Holder Support Screw Nut....
150368	23092	" " " Steady Wire.....
150369	23092	"* Guide.....
178J	23092	" " " Screw.....
150370	23092	Thread Unwinder complete, for inverted cones, Nos. 178J, 51082R, 150364, 150365, 150367, 150369, three wood screws, 1 1/2 in. No. 16 F.H. and four each 164J, 19020, 150366 and 150368.....

## THREAD UNWINDER SPOOL RESTS

### FOR USE WHEN SPOOLS ARE USED

### IN PLACE OF CONES OF THREAD

### FOR USE WITH THREAD UNWINDER NO. 150370

No.	Plate	Name
150647	23092	Spool Rest with 178J.....
150203	23092	" " Cushion (felt).....
150649	23092	" " Rod.....
178J	23092	" " " Set Screw.....
178J	23092	" " " Set Screw.....
150662	23092	Spool Rest complete (for four spools) Nos. 178J, 150649 and four each 150203 and 150647.....

## NUMERICAL LIST OF PARTS

## NUMERICAL LIST OF PARTS

No.	Plate	Name
110C	23085	Tension (needle thread) Releasing Shaft Crank Connecting Link Hinge Screw...
116E	23078	Arm Screw.....
122E	23080	Looper Avoiding Eccentric Forked Connection Bracket Screw.....
131C	23076	Oil Cup Body Cap Retainer Screw for 139126.....
144D	23090	Idler Pulley Shaft Cap Screw for 150496.
146R	23087	Belt Guard Screw for 139398.....
146R	23086	Machine Screw for mounting machine to table.....
157J	23080	Feed Lifting Eccentric Forked Connection Screw.....
164J	23092	Thread Unwinder Thread Cone Holder Screw for 150370.....
168C	23090	Idler Pulley Shaft Set Screw for 150529 and 150530.....
171E	23085	Slack Thread Regulator Holder Crank Clamping Screw for 131405.....
172E	23080	Looper Holder Clamping Screw for 139093.
175E	23080	Looper Driving Arm Connection Cap (lower) Screw for 139066.....
175E	23080	Looper Driving Arm Connection Cap (upper) Screw for 139066.....
175E	23080	Needle Bar Connecting Stud Clamping Screw for 139108.....
175E	23076	Thread (looper) Take-up Stripper Plate Bracket Screw.....
176J	23085	Thread (looper) Thread Guide Bracket Screw.....
176J	23085	Thread (looper) Thread Tube (front of bed) Cover Hinge Plate Screw.....
178J	23092	Thread Unwinder Thread Guide Screw for 150370.....
178J	23092	Thread Unwinder Spool Rest Rod Set Screw for 150662.....
178J	23092	Thread Unwinder Spool Rest Set Screw for 150647.....
190J	23079	Looper Gate Retaining Spring Screw.....
190J	23082	Presser Foot Screw.....
202R	23076	Bed Rotary Shaft Ball Bearing (left) Cover Screw.....
202J	23085	Thread (looper) Thread Guide Bracket Support Screw (lower).....
202J	23085	Thread (looper) Thread Tube (front of bed) Cover Lock Spring Screw.....
202E	23085	Thread (needle) Take-up Clamping Screw for 139391.....

## NUMERICAL LIST OF PARTS

No.	Plate	Name
203J	23076	Thread (looper) Take-up Stripper Screw for 139280.....
203J	23085	Thread (looper) Thread Tube (belt guard) Seat Screw.....
206J	23080	Looper Thread Guide Screw.....
207J	23076	Thread (looper) Take-up Stripper Plate Screw for 139280.....
207J	23085	Thread (needle) Eyelet Screw.....
217J	23080	Feed Eccentric Clamping Washer Screw for 139052.....
217J	23085	Slack Thread Regulator Screw.....
219J	23076	Thread (looper) Take-up Thread Guide (right) Screw for 139280.....
229J	23085	Thread (looper) Thread Guide (left) Screw.....
229J	23085	Thread (looper) Thread Guide (right) Screw.....
229J	23085	Thread (looper) Thread Tube (front of bed) Cover Catch Screw for 139170...
229J	23085	Thread (needle) Thread Guide (left) Screw.....
229J	23085	Thread (needle) Thread Guide (right) Screw.....
237J	23076	Thread (looper) Take-up Thread Guide (left) Screw for 139280.....
237J	23085	Thread (looper) Thread Guide Bracket Support Screw (upper).....
240J	23076	Thread (looper) Take-up Thread Separator Thread Retainer Screw for 139280....
316C	23085	Tension (needle thread) Releasing Shaft Stop Screw.....
330R	23090	Idler Pulley Shaft Ball Bearing Cover Screw for 150496.....
330W	23080	Needle Bar Thread Guide Screw.....
356C	23090	Idler Pulley Shaft Bracket Shaft Set Screw for 150528.....
361C	23088	Treadle Pitman Rod Clamp Set Screw for 80223.....
362C	23088	Treadle Pitman Rod Spring Collar Set Screw for 2762.....
376J	23085	Tension (needle thread) Bracket Screw...
391C	23080	Face Plate (lower half) Screw.....
430C	23085	Tension (looper thread) Body Set Screw..
435C	23080	Looper Holder Shaft Bushing (back) Set Screw.....
435C	23080	Looper Holder Shaft Bushing (front) Set Screw.....
437C	23092	Thread Unwinder Rod Set Screw for 150364
443C	23080	Feed Bar Hinge Pin Set Screw.....
443C	23080	Looper Driving Arm Hinge Stud Set Screw.

## NUMERICAL LIST OF PARTS

No.	Plate	Name
445C	23088	Starting Treadle Shaft Collar Set Screw for 150216.....
453C	23080	Needle Guard Holder Set Screw.....
453C	23085	Slack Thread Regulator Connecting Link Connecting Stud Set Screw for 139300
456C	23080	Looper Eccentric Connection Slide Block Screw Stud Set Screw for 139060.....
456C	23076	Tension (needle thread) Nipper Cam Set Screw for 139308.....
462C	23076	Bed Rotary Shaft Ball Bearing (intermediate) Sleeve Set Screw for 139028....
574W	23085	Pressure Regulating Thumb Screw.....
624C	23085	Tension (needle thread) Releasing Shaft Crank Set Screw for 54872.....
665J	23082	Presser Foot Plate Hinge Stud Position Screw for 139223 and 139420.....
665J	23076	Thread (looper) Take-up Stripper Plate Thread Guard Screw for 139280.....
691F	23082	Throat Plate Screw.....
692C	23090	Idler Pulley Shaft Bracket (lower) Clamping Screw for 150529.....
692C	23090	Idler Pulley Shaft Bracket (upper) Clamping Screw for 150530.....
783E	23078	Bed Extension Screw.....
802D	23085	Presser Bar Lifting Lever Hinge Screw...
807D	23085	" " " Bracket Lifter Hinge Screw.....
997J	23085	Thread (needle) Take-up (auxiliary) Clamp Screw.....
1036C	23076	Needle Bar Connecting Link Hinge Stud Set Screw for 139199 and 139375.....
1047C	23080	Looper Driving Arm Connecting Link Hinge Pin Set Screw for 139082 and 139073.
1053E	23080	Face Plate (upper half) Position Plate Screw.....
1057E	23080	Looper Driving Arm Connection Crank Clamping Screw for 139069.....
1057C	23080	Needle Bar Connecting Stud Slide Block Guide Screw.....
1057E	23080	Presser Bar Lifting Bracket Clamping Screw for 139130.....
1133E	23080	Needle Bar Bushing (lower) Set Screw....
1133E	23080	" " Guide Set Screw.....
1133E	23080	Presser Bar Bushing (lower) Set Screw...
1133E	23080	" " " (upper) Set Screw...
1149C	23076	Arm Rotary Shaft Crank Set Screw for 139199 and 139375.....
1149C	23085	Tension (needle thread) Nipper Body Set Screw.....
1167E	23080	Needle Guard Screw.....



## NUMERICAL LIST OF PARTS

No.	Plate	Name
1250C	23076	Thread (looper) Take-up Cover Position Screw Stud.....
1253C	23080	Looper Eccentric Connection Slide Block Screw Stud Collar Set Screw for 139076.....
1255E	23082	Feed Dog Screw.....
1259C	23080	Looper Eccentric and Feed Lifting Eccentric Set Screw for 139072.....
1259C	23077	Needle Bar Connecting Link Hinge Stud Set Screw (short) for 139375.....
1266C	23076	Thread (looper) Take-up Set Screw for 139144.....
1324C	23080	Looper Avoiding Eccentric Forked Connection Crank Clamping Screw for 139257
1423J	23085	Slack Thread Regulator Holder Crank Cap Screw.....
1423J	23085	Tension (looper thread) Regulating Screw Cap Screw for 139278.....
1443B	23091	Lap Seam Feller Screw.....
1448C	23090	Idler Pulley Shaft Set Screw for 150480.
1449J	23085	Thread (needle) Take-up Plate Spring Screw for 139392.....
1454E	23080	Looper Holder Shaft Collar Clamping Screw for 139097.....
1480D	23076	Bed Rotary Shaft Screw (left).....
1498F	23080	Needle Set Screw for 139116.....
1520J	23080	Feed Bar Hinge Pin Set Screw Lock Nut...
1520J	23080	Looper Driving Arm Connection Crank Ball Screw Stud Nut.....
1539W	23085	Pressure Regulating Thumb Screw Lock Nut
1547J	23085	Tension (needle thread) Releasing Shaft Stop Screw Nut.....
1698R	23085	Tension (needle thread) Nipper Stud Nut for 139373.....
2102	23085	Tension (needle thread) Disc.....
2762	23088	Treadle Pitman Rod Spring Collar with 362C, for 126684.....
2807	23086	Machine Mounting Cushion Bolt Nut Washer
4879	23088	Foot Lifter Chain Connecting Link for 150491.....
5684	23085	Tension (needle thread) Nipper Stud Wearing Sleeve Pin for 139310.....
6439	23088	Foot Lifter Chain, 36 in. to 45 in. with 56864 and 56865, for 150491.....
7071	23080	Feed Eccentric Clamping Washer for 139052.....
7071	23076	Thread (looper) Take-up Thread Guide (right) Screw Washer for 139280.....
8582	23078	Arm Dowel Pin.....
9610	23082	Presser Foot Yielding Heel Connection Spring for 139223.....

## NUMERICAL LIST OF PARTS

No.	Plate	Name
11119	23076	Arm Oil Tube with 52045 (for oiling Tension Needle Thread Nipper).....
12162	23085	Thread (looper) Thread Tube (front of bed) Cover Hinge Pin.....
13218	23085	Tension (needle thread) Nipper Stud Spring for 139373.....
13538	23085	Tension (needle thread) Nipper Tension Plate Position Pin for 139307.....
*15404	----	Trade Mark for 139282.....
15405	----	" " Rivet for 139282.....
17022	23076	Thread (looper) Take-up Stripper Screw Washer for 139280.....
18055	23082	Presser Foot Yielding Heel Connection Hinge Pin for 139223 and 139420.....
18055	23082	Presser Foot Yielding Heel Hinge Pin for 139223 and 139420.....
18191	23085	Thread (looper) Thread Tube (front of bed) Cover Lock Spring Position Pin for 139168.....
19020	23092	Thread Unwinder Thread Cone Holder Screw Washer for 150370.....
23250	23088	Treadle Pitman Rod Spring Washer for 126684.....
23535	23086	Wrench (Accessories).....
25303	23080	Presser Bar Ball, size 1/4 in. for 139128.....
26276	23080	Looper Position Pin for 139093.....
27639	23089	Treadle Pitman Rod for 60626.....
29234	23080	Face Plate (upper half) Position Plate..
32572	23085	Tension (needle thread) Releasing Disc..
38456	23080	Presser Bar Bushing (upper).....
38467	23085	" " Spring (flat).....
38468	23085	" " Stud.....
42639	23085	Tension (looper thread) Regulating Screw Nut Position Pin for 139140.....
42727	23085	Tension (looper thread) Tension Plate Position Pin for 139275.....
46681	----	Starting Treadle Shaft Bracket for 60502
50004C	23079	Bed Cover Screw.....
50040D	23076	" Rotary Shaft Screw (right).....
50150C	23080	Looper Avoiding Eccentric Set Screw for 139058.....
50318W	23080	Thread Cutter Screw.....
50326C	23085	Tension (needle thread) Screw Stud for 59539.....
50328C	23080	Feed Regulating Screw for 139052.....
50411E	23079	Bed Cover Gasket Clamping Plate Screw for 139251.....
50422C	23076	Arm Rotary Shaft Ball Bearing (back) Case Set Screw.....

No.	Plate	Name
50422C	23076	Bed Rotary Shaft Ball Bearing (right) Case Set Screw.....
50608R	23079	Bed Cover Hole Plug Screw.....
50608R	23076	" Oil Drain Plug Screw.....
50617B	23076	Oil Cup Body Oil Plug Screw for 139126..
51061C	23080	Feed Eccentric Body Set Screw for 139052
51069R	23086	Machine Mounting Cushion Bolt with 51581R.....
51082R	23092	Thread Unwinder Thread Cone Holder Sup- port Screw with 51581R, for 150370
51183R	23090	Idler Screw for 150486.....
51185F	23076	Arm Rotary Shaft Screw.....
51224W	23080	Face Plate (upper half) Thumb Screw....
51282J	23076	Thread (looper) Take-up Cover Lock Spring Screw for 139280.....
51283C	23076	Balance Wheel Set Screw for 139011 and 139418.....
51485E	23080	Looper Clamping Screw for 139093.....
51486C	23085	Tension (looper thread) Regulating Screw for 139278.....
51570C	23085	Tension (needle thread) Regulating Thumb Nut for 59539.....
51581R	23086	Machine Mounting Cushion Bolt Nut for 51069R.....
51581R	-----	Thread Unwinder Thread Cone Holder Sup- port Screw Nut for 51082R.....
52045	23076	Arm Oil Tube Packing (wick) for 11119...
52146	23080	Needle Bar Guide Oil Pad (inside) braided cotton.....
54070	23085	Tension (needle thread) Bracket.....
54071	23085	" " " Releasing Shaft.
54095	23085	Thread (needle) Take-up Plate for 139392
54872	23085	Tension (needle thread) Releasing Shaft Crank with 624C.....
54988	23085	Tension (needle thread) Releasing Pin...
56864	23088	Foot Lifter Chain Hook (large) for 6439.
56865	23088	" " " " (small) for 6439.
59019	23080	Needle Bar Thread Guide Screw Washer....
59456	23080	" " Connecting Stud Slide Block Guide Screw Washer.....
59456	23085	Tension (needle thread) Nipper Stud Washer for 139373.....
59534	23085	Tension (looper thread) Spring for 139278.....
59537	23085	Tension (needle thread) Spring Bushing (large).....
59538	23085	Tension (needle thread) Spring Bushing (small).....
59539	-----	Tension (needle thread) Screw Stud 50326C with 51570C.....

No.	Plate	Name
60502	23088	Starting Treadle Shaft Bracket 46681 with two wood screws 1 in.No.14, for 150491.....
60626	23089	Treadle Pitman Rod complete for 150498, Nos. 80223 and two 27639.....
67819	23088	Treadle Pitman Rod (lower) for 126684...
67820	23088	" " " (upper) for 126684...
68164	23085	Thread (needle) Take-up Plate Spring for 139392.....
68350	23076	Arm Rotary Shaft Ball Bearing (back) Oil Cup.....
68350	23076	Arm Rotary Shaft Ball Bearing (front) Oil Cup.....
68350	23076	Bed Rotary Shaft Ball Bearing (right) Oil Cup.....
80223	23088	Treadle Pitman Rod Clamp with 361C, for 60626 and 126684.....
120341	23086	Tweezers (curved) Accessories.....
120344	23086	Oiler (copper plated) with 120345 (Ac- cessories).....
120345	23086	Oiler Spout, 4 1/2 in. long, for 120344.
120440	23086	Screw Driver (large) Accessories.....
121108	23086	" " (small) Accessories.....
121449	23091	Lap Seam Feller Clamping Plate.....
121628	23091	" " " (adjustable) on Shank for medium heavy and heavy weight material.....
121629	23091	Lap Seam Feller on Shank with Yielding Lower Scroll for medium heavy and heavy weight material.....
126684	23088	Treadle Pitman Rod complete for 150497, Nos. 2762,67819,67820,80223 and two each 23250 and 150208.....
128390	23083	Presser Foot Plate Hinge Stud for 139420
128551	23080	Looper Driving Arm Connection Crank Ball Screw Stud Nut Lock Washer.....
130328	23090	Idler Pulley Shaft Oil Cup for 150486...
131198	23085	Presser Bar Spring (auxiliary).....
131319	23076	Arm Rotary Shaft Ball Bearing (back) Oil Cup Oil Pad (braided cotton).....
131319	23076	Arm Rotary Shaft Ball Bearing (front) Oil Cup Oil Pad (braided cotton)....
131319	23076	Bed Rotary Shaft Ball Bearing (right) Oil Cup Oil Pad (braided cotton)....
131405	23085	Slack Thread Regulator Holder Crank with 171E.....
131406	23085	Slack Thread Regulator Holder Crank Con- necting Link.....
131496	23085	Thread (needle) Take-up (auxiliary) Clamp.....

No.	Plate	Name
131534	23083	Presser Foot Yielding Heel Connection Spring for 139420.....
131696	23085	Tension (needle thread) Thread Guide (double).....
131705	23083	Presser Foot Shank for 139420.....
131706	23083	" " Yielding Heel for 139420...
131707	23083	" " " " Connection for 139420.....
131741	23085	Tension (needle thread) Spring.....
132231	23076	Bed Rotary Shaft Ball Bearing (left)....
135060	-----	Front Plank, 1 5/8 in. thick, 19 in. wide, 46 1/2 in. long, for Series 1500, 1900 and 2900 Motors, for Universal Electric Transmitter Tables..
135061	-----	Front Plank, 1 5/8 in. thick, 19 in. wide, 48 in. long, for Series 1500, 1900 and 2900 Motors, for Electric Transmitter Tables (cast iron legs).
135062	-----	Front Plank, 1 5/8 in. thick, 19 in. wide, 46 1/2 in. long, for Series 1700 Motors, for Universal Electric Transmitter Tables.....
135063	-----	Front Plank, 1 5/8 in. thick, 19 in. wide, 48 in. long, for Series 1700 Motors, for Electric Transmitter Tables (cast iron legs).....
135064	-----	Front Plank, 1 5/8 in. thick, 19 in. wide, 46 1/2 in. long, for Series S 39, S 49, S 59 and S 69 Electric Transmitters, for Universal Electric Transmitter Tables.....
135065	-----	Front Plank, 1 5/8 in. thick, 19 in. wide, 48 in. long, for Series S 39, S 49, S 59 and S 69 Electric Transmitters, for Electric Transmitter Tables (cast iron legs).....
135068	-----	Front Plank, 1 5/8 in. thick, 19 in. wide, 46 1/2 in. long, for Universal Low Shaft Power Table.....
135069	-----	Front Plank, 1 5/8 in. thick, 19 in. wide, 48 in. long, for Old Style Low Shaft Power Table.....
135098	-----	Front Plank, 1 5/8 in. thick, 19 in. wide, 46 1/2 in. long, for Universal Safety Power Table.....
139003	23076	Arm Rotary Shaft Ball Bearing (back) Case.....
139004	23076	Arm Rotary Shaft Ball Bearing (back) Case Nut.....
139004	23076	Bed Rotary Shaft Ball Bearing (right) Case Nut.....

No.	Plate	Name
139005	23076	Arm Rotary Shaft Ball Bearing (back) Spacing Collar.....
139006	23076	Arm Rotary Shaft Ball Bearing (front)...
139007	23076	" " " " Oil Retainer (back).....
139008	23076	Arm Rotary Shaft Ball Bearing (front) Oil Retainer (front).....
139010	23076	Arm Rotary Shaft Sprocket Wheel with two each 201254C and 202253.....
139011	23076	Balance Wheel, 2 in. pulley, with two 51283C, for 231-7 Machine.....
139017	23079	Bed Cover Hole Plug Screw Washer.....
139017	23076	" Oil Drain Plug Screw Washer.....
139022	23079	" " Gauge.....
139025	23076	" Rotary Shaft.....
139026	23076	" " " Ball Bearing (intermediate).....
139028	23076	Bed Rotary Shaft Ball Bearing (intermediate) Sleeve with two 462C.....
139030	23076	Bed Rotary Shaft Ball Bearing (left) Cover.....
139031	23076	Bed Rotary Shaft Ball Bearing (left) Cover Gasket.....
139032	23076	Bed Rotary Shaft Ball Bearing (right) Case.....
139033	23076	Bed Rotary Shaft Ball Bearing (right) Spacing Collar.....
139034	23078	Bed Rotary Shaft Belt Guard with two 200363C.....
139035	23078	Bed Rotary Shaft Belt Guard Cover for 139036.....
139036	23078	Bed Rotary Shaft Belt Guard Cover 139035 with 139037.....
139037	23078	Bed Rotary Shaft Belt Guard Cover Gasket (cork) for 139036.....
139038	23076	Bed Rotary Shaft Sprocket Wheel with 202253 and two 201254C.....
139039	23080	Face Plate (lower half).....
139040	23080	" " " " Gasket (cork)...
139041	23080	" " (upper half).....
139043	23080	Feed Bar.....
139046	23080	" " Hinge Pin Slide Block.....
139049	23083	Feed Dog with row of teeth between the needles, 19 teeth (14 teeth to the inch) for 1/4 in. to 3/8 in. gauges, for 139186, for Work Shirts.....
139052	23080	Feed Eccentric (adjustable) complete, Nos. 217J, 7071, 50328C and two 51061C
139053	23080	Feed Eccentric Slide Block.....
139054	23080	" Lifting Eccentric Forked Connection

No.	Plate	Name
139055	23080	Feed Lifting Eccentric Forked Connection Slide Block.....
139055	23080	Looper Avoiding Eccentric Forked Connection Slide Block.....
139056	23082	Looper (back).....
139057	23082	" (front).....
139058	23080	" Avoiding Eccentric with two 50150C
139059	23080	" " " Forked Connection
139060	23080	" " " " " "
		Bracket with 456C.....
139062	23080	Looper Driving Arm with 1047C, for 139063.....
139063	-----	Looper Driving Arm 139062 with 139066 and 139070.....
139064	23080	Looper Driving Arm Connecting Link.....
139065	23080	" " " " " Hinge Pin.....
139066	23080	Looper Driving Arm Connection with four 175E, for 139063.....
139069	23080	Looper Driving Arm Connection Crank with 1057E.....
139070	23080	Looper Driving Arm Connection Crank Ball Screw Stud for 139063.....
139072	23080	Looper Eccentric and Feed Lifting Eccentric with two 1259C.....
139073	23080	Looper Eccentric Connection with 1047C..
139074	23080	" " " Slide Block,
139075	23080	" " " " "
		Screw Stud.....
139076	23080	Looper Eccentric Connection Slide Block Screw Stud Collar with two 1253C....
139093	23080	Looper Holder with 172E, 26276 and 51485E
139094	23080	" " Shaft.....
139095	23080	" " " Bushing (back).....
139096	23080	" " " " (front).....
139097	23080	" " " Collar with 1454E...
139099	23080	Needle Bar (hollow) for 139100.....
139100	-----	Needle Bar complete for 231-7 Machine, Nos. 139099 and 139116.....
139101	23080	Needle Bar Bushing (lower) for 231-7 Machine.....
139102	23080	Needle Bar Connecting Link for 139103...
139103	-----	" " " " 139102 with 139105 and 139108, for 139228 and 139376.....
139105	23076	Needle Bar Connecting Link Hinge Stud for 139103.....
139108	23080	Needle Bar Connecting Stud with 175E, for 139103.....
139110	23080	Needle Bar Connecting Stud Oil Pad (wick).....

No.	Plate	Name
139111	23080	Needle Bar Connecting Stud Slide Block..
139112	23080	" " " " " "
		Guide.....
139113	23080	Needle Bar Guide for 231-7 Machine.....
139114	23080	" " " Oil Pad (outside) felt,
139115	23080	" " Thread Guide.....
139116	23080	" Clamp with two 1498F, for 139100 and 139378.....
139117	23080	Needle Guard for 3/32 in. to 3/16 in. gauges.....
139118	23082	Needle Guard for 7/32 in. to 9/32 in. gauges.....
139119	23083	Needle Guard for 5/16 in. gauge.....
139120	23080	" " Holder.....
139121	23076	Oil Cup Body for 139126.....
139122	23076	" " " Cap (transparent) for 139126
139123	23076	" " " " Gasket (cork) for 139126
139124	23076	" " " " Retainer for 139126.....
139125	23076	" " " Oil Plug Screw Washer for 139126.....
139126	23076	Oil Cup complete for oiling Needle Bar Connecting Link, Nos. 50617B, 139121 to 139125 and four 131C.....
139127	23076	Oil Cup Gasket (soft leather).....
139128	23080	Presser Bar with 25303.....
139130	23080	" " Lifting Bracket with 1057E..
139131	23085	" " " " Lifter.....
139132	23085	" " " Lever.....
139133	23085	" " " " Spring.....
139140	23085	Tension (looper thread) Regulating Screw Nut with 42639, for 139278.....
139143	23085	Tension (needle thread) Releasing Shaft Crank Connecting Link.....
139144	23076	Thread (looper) Take-up with two 1266C..
139145	23076	" " " Cover for 139280
139146	23076	" " " " Hinge Pin for 139280.....
139147	23076	Thread (looper) Take-up Cover Lock Spring for 139280.....
139148	23076	Thread (looper) Take-up Stripper for 139280.....
139149	23076	Thread (looper) Take-up Stripper Plate for 139280.....
139152	23076	Thread (looper) Take-up Stripper Plate Thread Guard for 139280.....
139153	23076	Thread (looper) Take-up Thread Guard (fibre) for 139280.....
139154	23076	Thread (looper) Take-up Thread Guide (left) for 139280.....
139155	23076	Thread (looper) Take-up Thread Guide (right) for 139280.....

No.	Plate	Name
139156	23076	Thread (looper) Take-up Thread Separator for 139280.....
139157	23076	Thread (looper) Take-up Thread Separator Thread Retainer for 139280.....
139158	23085	Thread (looper) Thread Guide (left)....
139158	23085	" " " " (right)....
139158	23085	" (needle) Thread Guide (left)....
139158	23085	" " " " (right)....
139159	23085	" (looper) Thread Guide Bracket....
139160	23085	" " " " " Sup-port.....
139162	23085	Thread (looper) Thread Tube (belt guard) Bushing for 139164.....
139164	23085	Thread (looper) Thread Tube (belt guard) with four 139162.....
139167	23085	Thread (looper) Thread Tube (front of bed) Bushing for 139168.....
139168	23085	Thread (looper) Thread Tube (front of bed) with 18191 and four 139167....
139169	23085	Thread (looper) Thread Tube (front of bed) Cover for 139170.....
139170	23085	Thread (looper) Thread Tube (front of bed) Cover 139169 with 139171 and two 229J.....
139171	23085	Thread (looper) Thread Tube (front of bed) Cover Catch for 139170.....
139172	23085	Thread (looper) Thread Tube (front of bed) Cover Hinge Plate.....
139173	23085	Thread (looper) Thread Tube (front of bed) Cover Lock Spring.....
139174	23085	Thread (looper) Thread Tube (front of bed) Cover Lock Spring Reinforcing Plate.....
139177	23085	Thread (needle) Eyelet.....
139180	23085	" " Thread Guide Bracket....
139186	23083	Throat Plate for 1/4 in. to 3/8 in. gauges, for 139049.....
139190	23086	Machine Cushion (round rubber).....
139191	23086	" Mounting Cushion (moulded rubber)
139195	23083	Needle Guard for 11/32 in. to 3/8 in. gauges.....
139199	23076	Arm Rotary Shaft Crank with two each 1036C and 1149C, for 139228.....
139217	23087	Belt Guard with two wood screws 3/4 in. No. 9 R.H., for use with Singer Universal Safety Power Table.....
139218	23082	Presser Foot Plate for 139223.....
139219	23082	" " " Hinge Stud for 139223
139220	23082	" " Shank for 139223.....
139221	23082	" " Yielding Heel for 139223...

No.	Plate	Name
139222	23082	Presser Foot Yielding Heel Connection for 139223.....
139223	23082	Presser Foot (triple hinged) complete, for 3/16 in. to 1/4 in. gauges, Nos. 9610, 139218, 139220 to 139222 and two each 665J, 18055 and 139219.....
139228	-----	Arm Rotary Shaft Crank 139199 with 139103, for 139284.....
139229	23080	Needle Bar Connecting Link Spacing Washer (thickness .004", .008" or .012")
139239	23076	Needle Bar Connecting Link Hinge Stud Oil Pad (braided cotton).....
*139249	-----	Bed.....
139251	23079	" Cover with 139253 and two 50411E....
139252	23079	" " Gasket (cork).....
139253	23079	" " " Clamping Plate for 139251
139256	23080	Feed Bar Hinge Pin (eccentric).....
139257	23080	Looper Avoiding Eccentric Forked Connection Crank (forked) with 1324C.....
139262	23079	Looper Gate (left) for Throat Plates 3/4 in. wide.....
139264	23083	Looper Gate (left) for Throat Plates 7/8 in. wide.....
139269	23079	Looper Gate (right) for Throat Plates 3/4 in. wide.....
139271	23083	Looper Gate (right) for Throat Plates 7/8 in. wide.....
139272	23079	Looper Gate Retaining Spring.....
139273	23080	" Thread Guide.....
139275	23085	Tension (looper thread) Body and Thread Guide with 42727, for 139278.....
139276	23085	Tension (looper thread) Tension Plate for 139278.....
139276	23085	Tension (needle thread) Nipper Tension Plate for 139373.....
139278	23085	Tension (looper thread) complete, Nos. 1423J, 51486C, 59534, 139140, 139275 and three 139276.....
139279	23076	Thread (looper) Take-up Stripper Plate Bracket for 139280.....
139280	23076	Thread (looper) Take-up Stripper Plate Bracket 139279 with 219J, 237J, 240J, 7071, 51282J, 139145 to 139149, 139152 to 139157 and two each 203J, 207J, 665J and 17022.....

No.	Plate	Name
139281	23080	Thread (looper) Thread Tube (side of bed).....
*139282	-----	Arm with 15404 and two 15405.....
139283	23076	" Rotary Shaft for 139284 and 139374..
139284	-----	" " " 139283 with 139228 and 139308 for 231-7 Machine.....
139299	23085	Slack Thread Regulator Holder.....
139300	23085	" " " Connecting Link Connecting Stud with 453C.....
139307	23085	Tension (needle thread) Nipper Body and Thread Guide with 13538 for 139373..
139308	23076	Tension (needle thread) Nipper Cam with two 456C, for 139284 and 139374.....
139309	23085	Tension (needle thread) Nipper Stud for 139310.....
139310	-----	Tension (needle thread) Nipper Stud 139309 with 5684 and 139311, for 139373.....
139311	23085	Tension (needle thread) Nipper Stud Wearing Sleeve for 139310.....
139337	23078	Bed Extension.....
139352	23080	Looper Driving Arm Hinge Stud.....
139366	23091	Lap Seam Feller Slide.....
139373	23085	Tension (needle thread) Nipper complete, Nos. 1698R, 13218, 59456, 139307, 139310 and three 139276.....
139374	-----	Arm Rotary Shaft 139283 with 139308 and 139376, for 231-8 Machine.....
139375	23077	Arm Rotary Shaft Crank with 1036C, 1259C and two 1149C, for 139376.....
139376	-----	Arm Rotary Shaft Crank 139375 with 139103, for 139374.....
139377	23081	Needle Bar (hollow) for 139378.....
139378	-----	Needle Bar complete for 231-8 Machine, Nos. 139116 and 139377.....
139379	23081	Needle Bar Bushing (lower) for 231-8 Machine.....
139382	23083	Feed Dog with row of teeth between the needles, 14 teeth (10 teeth to the inch) for 1/4 in. to 3/8 in. gauges, for 139385, for Light Weight Overalls.....
139383	23083	Presser Foot Plate for 139420.....
139385	23083	Throat Plate for 1/4 in. to 3/8 in. gauges, for 139382, 139414 and 139415
139388	23082	Feed Dog with row of teeth between the needles, 16 teeth (12 teeth to the inch) for 3/16 in. and 7/32 in. gauges, for 139389, for Work Shirts.

No.	Plate	Name
139389	23082	Throat Plate for 3/16 in. and 7/32 in. gauges, for 139388.....
139390	23085	Slack Thread Regulator.....
139391	23085	Thread (needle) Take-up with 202E, for 139392.....
139392	23085	Thread (needle) Take-up complete, Nos. 1449J, 54095, 68164 and 139391.....
139393	23085	Thread (needle) Take-up (auxiliary)....
139398	23087	Belt Guard with two 146R, for use with Individual Motors and Low Shaft Power Table.....
139410	23080	Presser Bar Bushing (lower).....
139411	23080	Looper Eccentric Connection Slide Block Screw Stud Washer (leather).....
139412	23081	Needle Bar Guide for 231-8 Machine.....
139414	23084	Feed Dog with row of teeth between the needles, 11 teeth (8 teeth to the inch) for 1/4 in. to 3/8 in. gauges, for 139385, for Heavy Weight Overalls.....
139415	23084	Feed Dog with row of teeth between the needles, 17 teeth (12 teeth to the inch) for 1/4 in. to 3/8 in. gauges, for 139385, for Light Weight Overalls.....
139416	23080	Thread Cutter (knife).....
139417	23080	" " " Guard.....
139418	23077	Balance Wheel, 3 in. pulley, with two 51283C, for 231-8 Machine.....
139420	23083	Presser Foot (triple hinged) complete for 1/4 in. to 3/8 in. gauges for overall work and shirt work, Nos. 131534, 131705 to 131707, 139383 and two each 665J, 13055 and 128390.....
140215C	23088	Starting Treadle Set Screw for 150487...
140215C	23088	" " Shaft Arm Set Screw for 150489.....
150203	23092	Thread Unwinder Spool Rest Cushion (felt) for 150662.....
150208	23088	Treadle Pitman Rod Spring for 126684....
150212	23088	Foot Lifter Treadle for 150491.....
150216	23088	Starting Treadle Shaft Collar with two 445C, for 150491.....
150364	23092	Thread Unwinder Base with two 437C, for 150370.....
150365	23092	Thread Unwinder Rod for 150370.....
150366	23092	" " Thread Cone Holder for 150370.....
150367	23092	Thread Unwinder Thread Cone Holder Support for 150370.....

No.	Plate	Name
150368	23092	Thread Unwinder Thread Cone Steady Wire for 150370.....
150369	23092	Thread Unwinder Thread Guide for 150370.
150370	23092	Thread Unwinder complete for inverted cones, Nos. 178J, 51082R, 150364, 150365, 150367, 150369, three wood screws 1 1/2 in. No. 16 F.H. and four each 164J, 19020, 150366 and 150368.....
150480	23090	Idler Bracket with 1448C, for 150486....
150481	23090	" Pulley for 150496.....
150482	23090	" " Shaft for 150496.....
150483	23076	Arm Rotary Shaft Ball Bearing (back)....
150483	23076	Bed Rotary Shaft Ball Bearing (right)...
150483	23090	Idler Pulley Shaft Ball Bearing for 150496.....
150484	23090	Idler Pulley Shaft Ball Bearing Cover for 150496.....
150485	23090	Idler Pulley Shaft Ball Bearing Cover Gasket (cork) for 150496.....
150486	23090	Idler complete (adjacent to Balance Wheel) Nos. 130328, 150480, 150496 and two 51183R.....
150487	23088	Starting Treadle with two 140215C, for 150491.....
150488	23088	Starting Treadle Shaft for 150491.....
150489	23088	" " " Arm with two 140215C, for 150491.....
150490	23088	Starting Treadle Spacing Collar for 150491.....
150491	-----	Starting and Foot Lifter Treadle complete for Individual Motors, for 150497 and 150498, Nos. 4879, 6439, 150212, 150216, 150487 to 150490 and two 60502.....
150496	23090	Idler Pulley and Shaft complete for 150486 and 150532, Nos. 144D, 150481 to 150485 and four 330R.....
150497	23088	Starting and Foot Lifter Treadle with Pitman complete for Universal Safety Power Table, Nos. 126684 and 150491.
150498	23089	Starting and Foot Lifter Treadle with Pitman complete for Low Shaft Power Table for Under Driver No. 150499, Nos. 60626 and 150491.....
150528	23090	Idler Base with 356C, for 150532.....
150529	23090	" Pulley Shaft Bracket (lower) with 168C and 692C, for 150532.....
150530	23090	Idler Pulley Shaft Bracket (upper) with 168C and 692C, for 150532.....

No.	Plate	Name
150531	23090	Idler Pulley Shaft Bracket Shaft for 150532.....
150532	23090	Idler complete for Under The Table, for Singer Universal Safety Power Table, Nos. 150528 to 150531, two 150496 and three wood screws 1 1/4 in. No. 12 F.H.....
150533	23090	Idler Guard with two wood screws 3/4 in. No. 9 R.H., for 150532.....
150647	23092	Thread Unwinder Spool Rest with 178J, for 150662.....
150649	23092	Thread Unwinder Spool Rest Rod for 150662.....
150662	23092	Thread Unwinder Spool Rest complete (for four spools) Nos. 178J, 150649 and four each 150203 and 150647.....
152004	23087	Belt Guard with two wood screws 1 in. No. 10 R.H.M.F.O. and A. for Series S 39, S 49, S 59 and S 69 Electric Transmitters.....
200092F	23078	Bed Rotary Shaft Belt Guard Cover Screw.
200363C	23078	" " " " " Set Screw for 139034.....
201254C	23076	Arm Rotary Shaft Sprocket Wheel Set Screw for 139010.....
201254C	23076	Bed Rotary Shaft Sprocket Wheel Set Screw for 139038.....
202253	23076	Arm Rotary Shaft Sprocket Wheel Spring Flange for 139010.....
202253	23076	Bed Rotary Shaft Sprocket Wheel Spring Flange for 139038.....
249311	23076	Bed Rotary Shaft Belt.....





231-8

20253

139126



139126 512850



20253

139126

139126

139126

139126

139126

139126 512850

506173 139125

139126 512850

139126 512850

139126 512850

139126 512850

139126 512850

139126 512850

139126 512850

139126 512850

139126 512850

210411

139126 512850

139126 512850

139126 512850

139126 512850

139126 512850

139126 512850

139126 512850

139126 512850

139126 512850

139126 512850

139126 512850

139126 512850

139126 512850

139126 512850

139126 512850

139126 512850

139126 512850

139126 512850

139126 512850

139126 512850

139126 512850

139126 512850

139126 512850

139126 512850

139126 512850

139126 512850

139126 512850

139126 512850

139126 512850

139126 512850

139126 512850

139126 512850

139126 512850

139126 512850

139126 512850

139126 512850

139126 512850

139126 512850

139126 512850

139126 512850

139126 512850

139126 512850

139126 512850

139126 512850

139126 512850

139126 512850

139126 512850

139126 512850

139126 512850

139126 512850

139126 512850

139126 512850

139126 512850

139126 512850

139126 512850

139126 512850

139126 512850

139126 512850

139126 512850

139126 512850

139126 512850

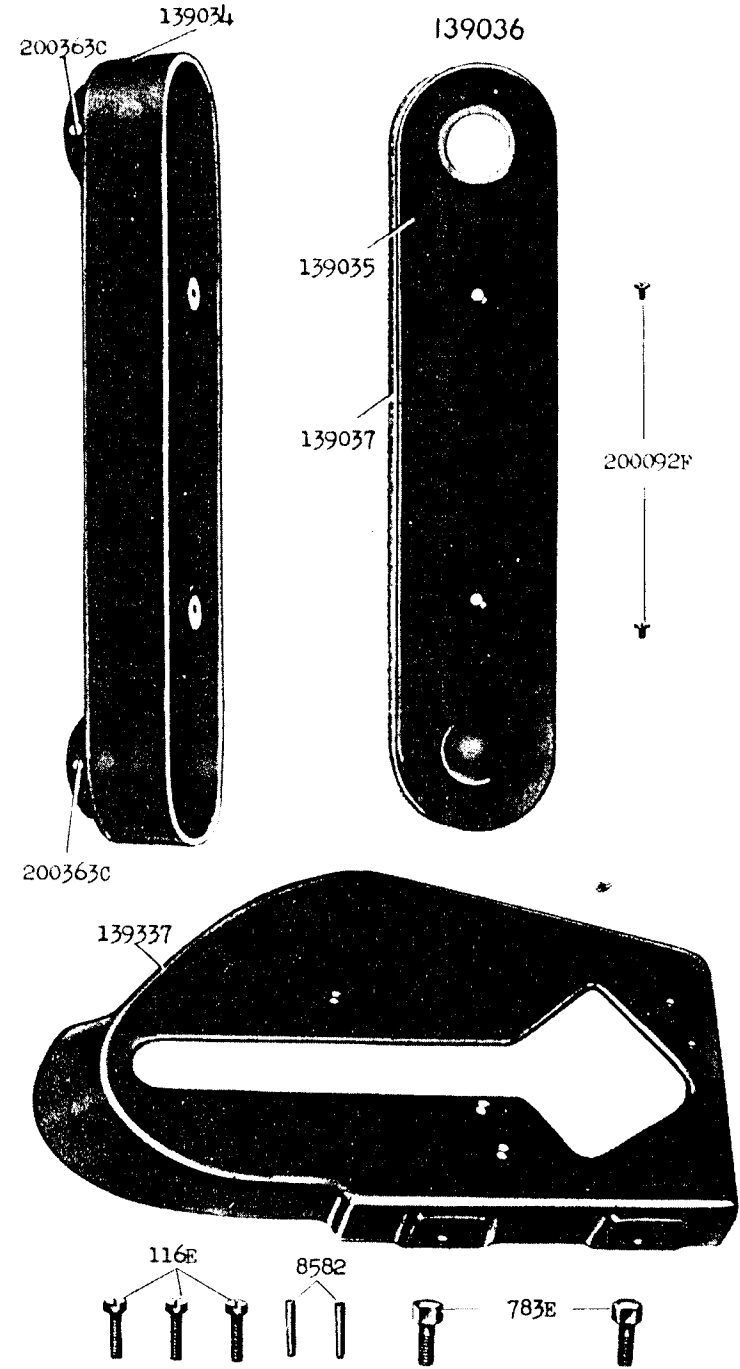
139126 512850

139126 512850

139126 512850

139126 512850

23078 - 1/4



139034

139036

200363C

139035

139037

200092F

200363C

139337

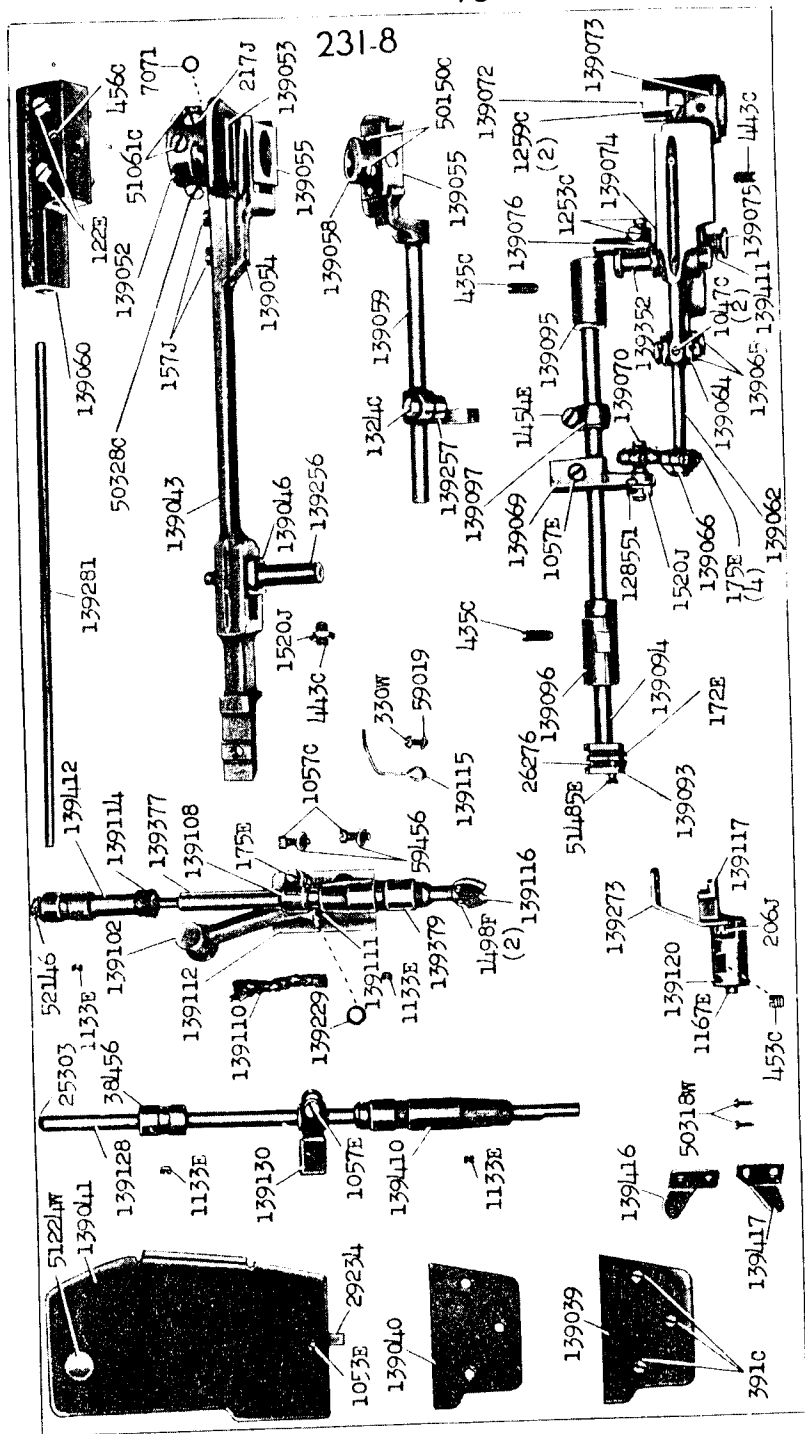
116E

8582

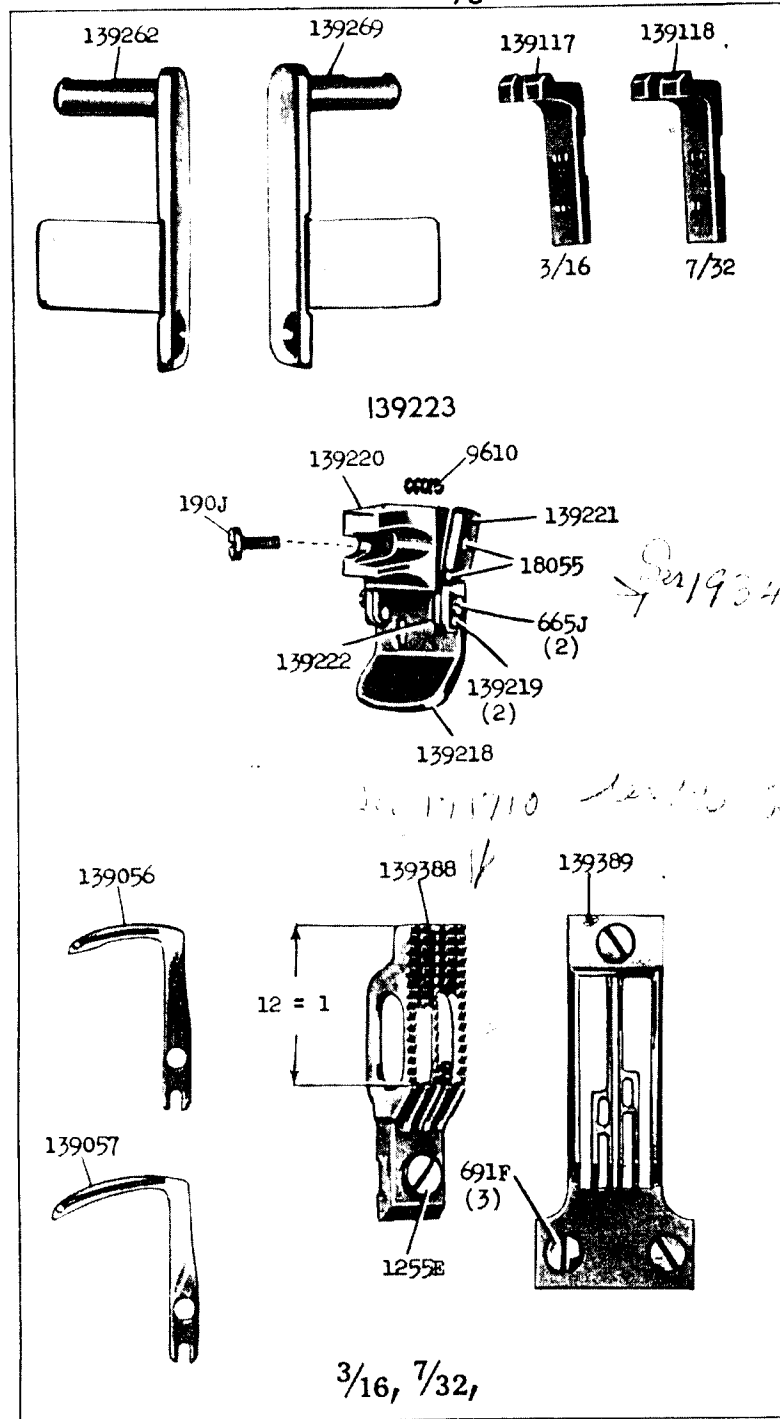
783E



23081 - 1/3

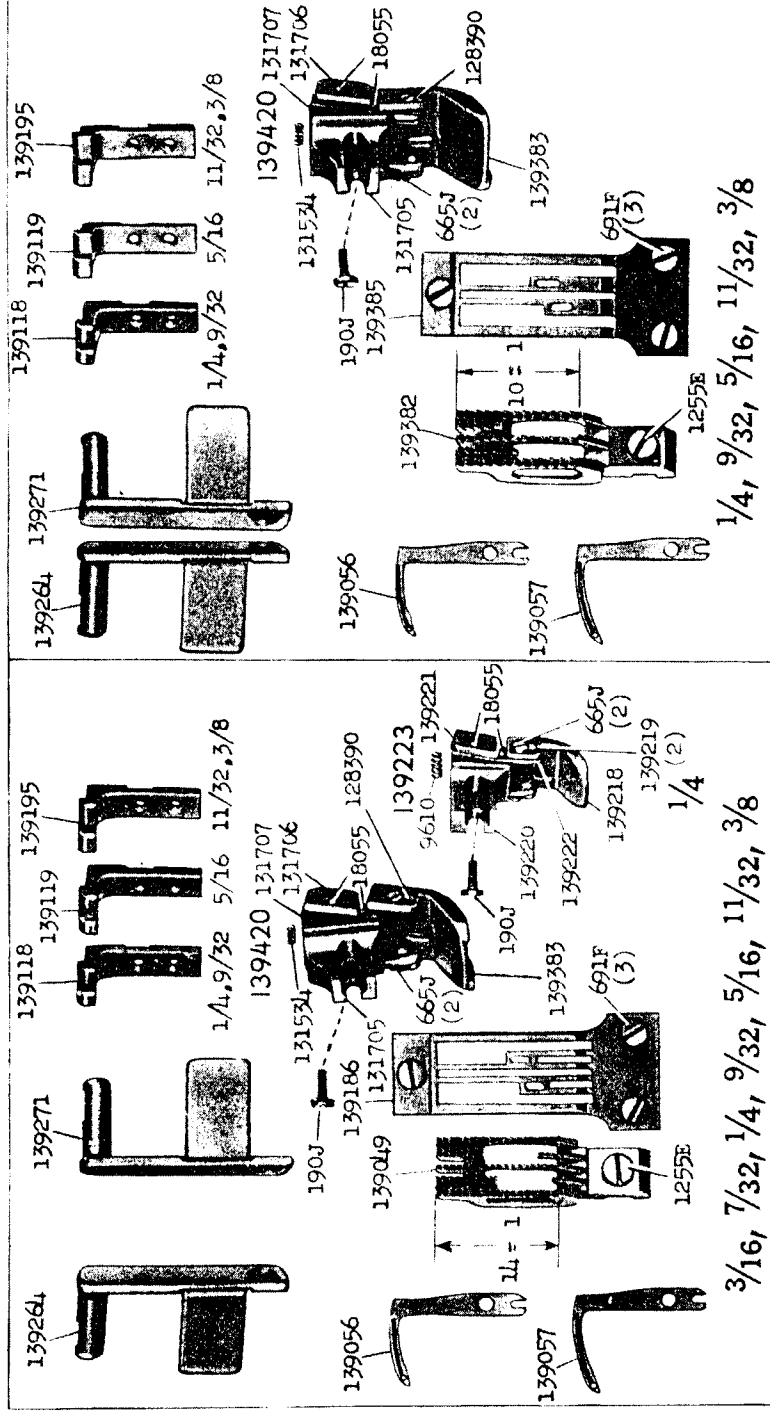


23082 - 2/3

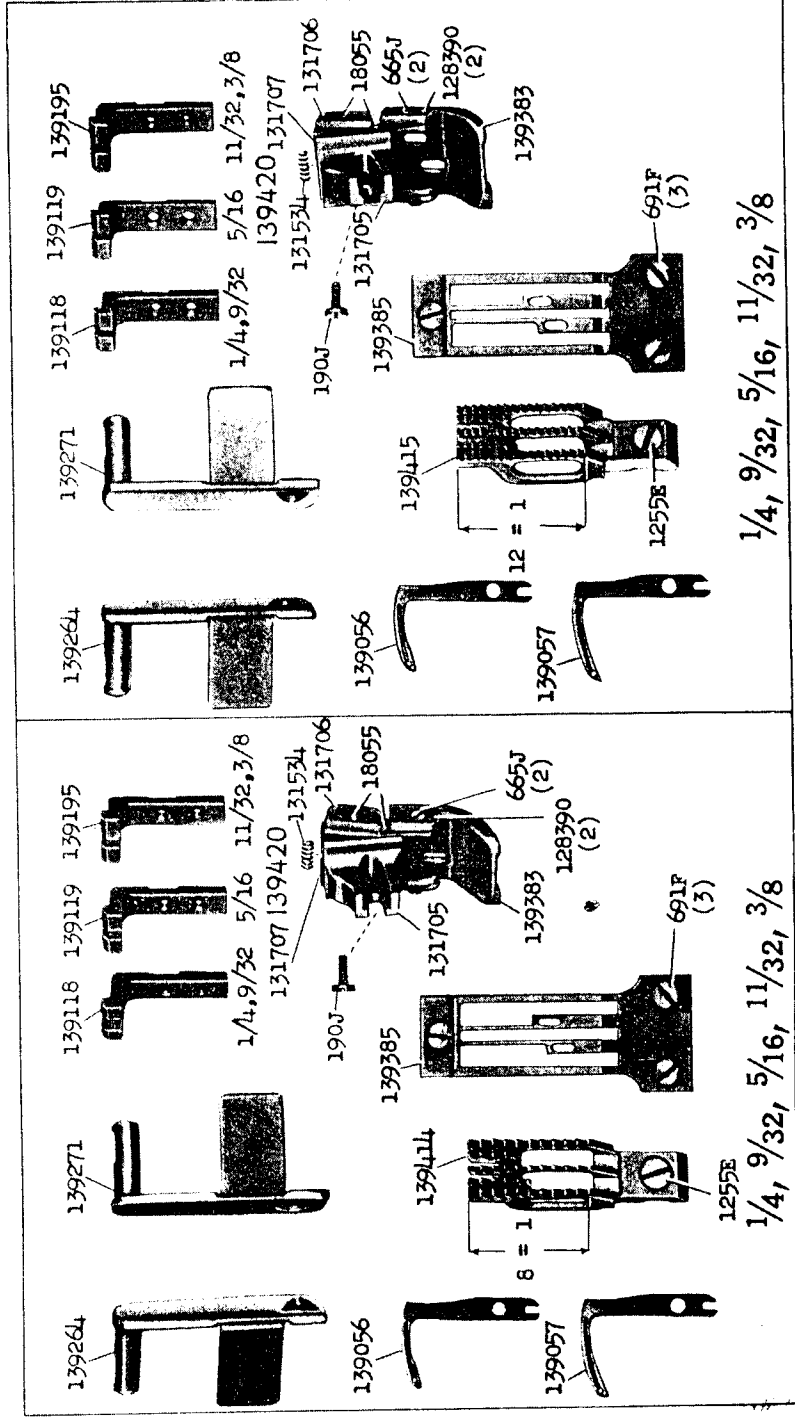


3/16, 7/32,

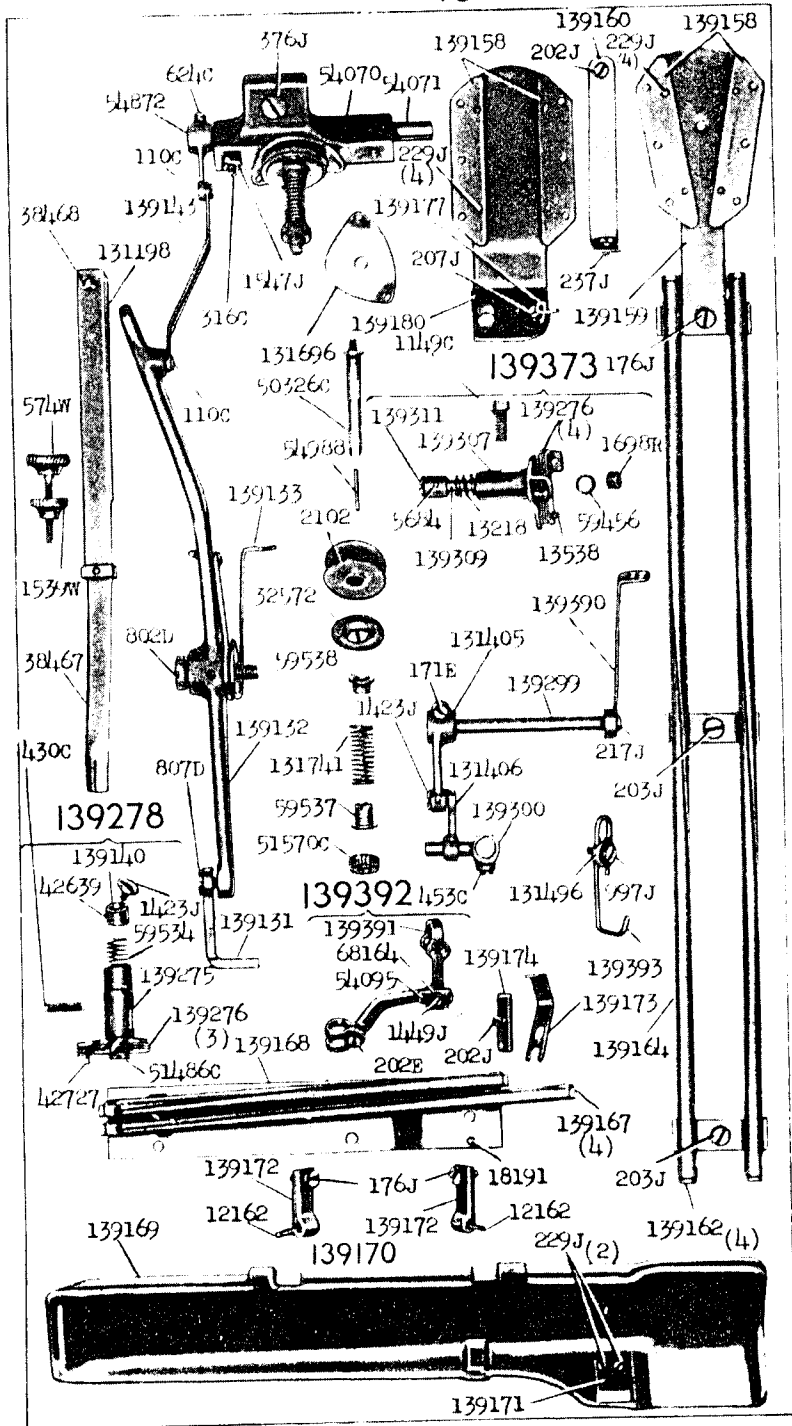
23083 - 1/2



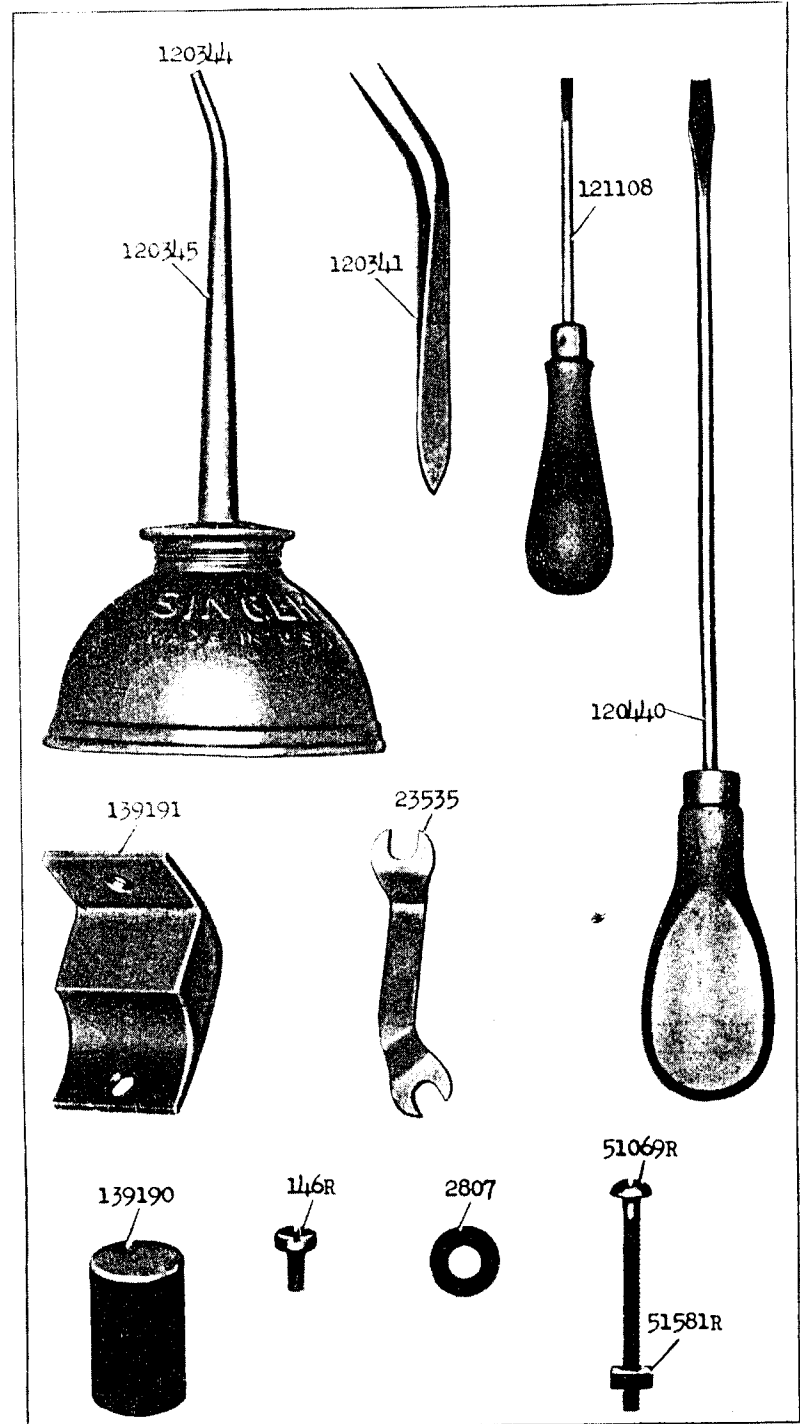
23084 - 1/2



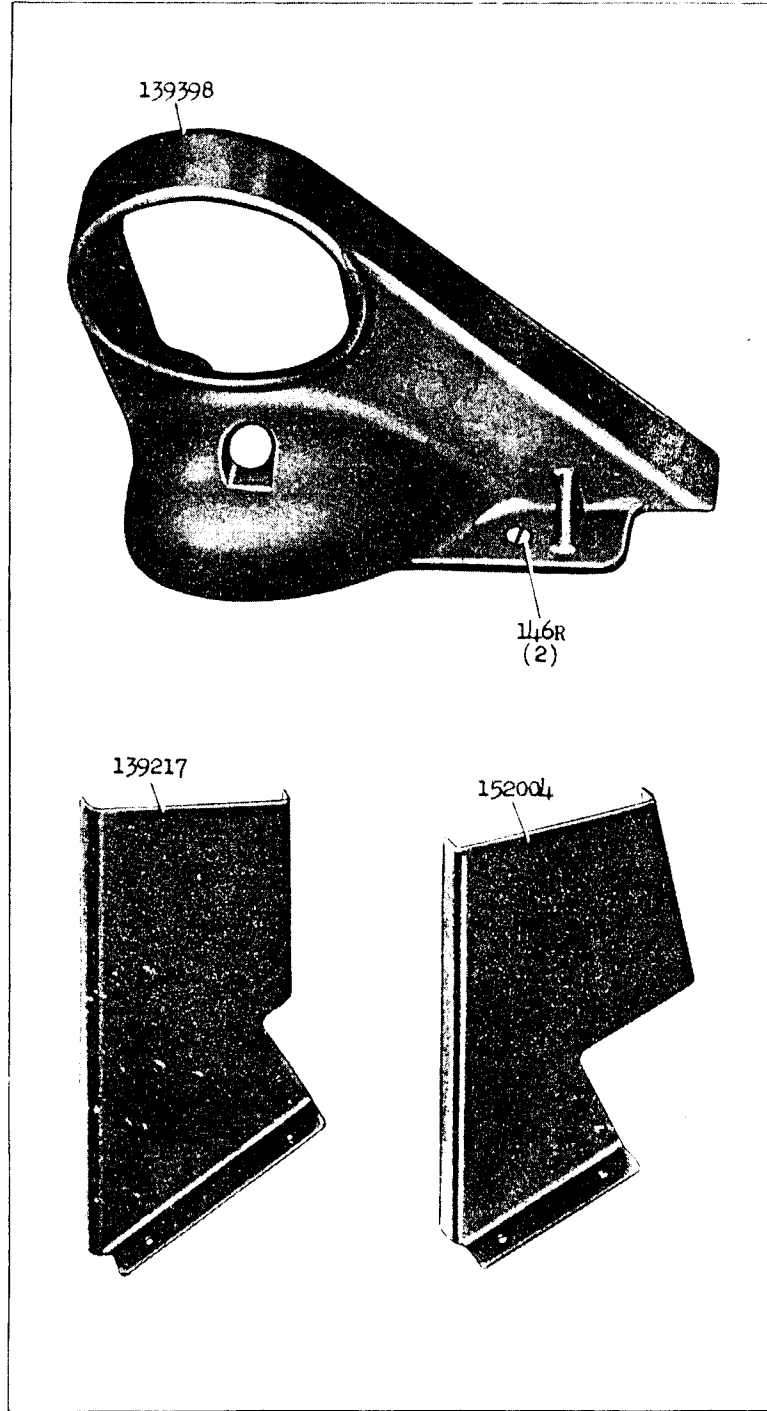
23085 - 1/3



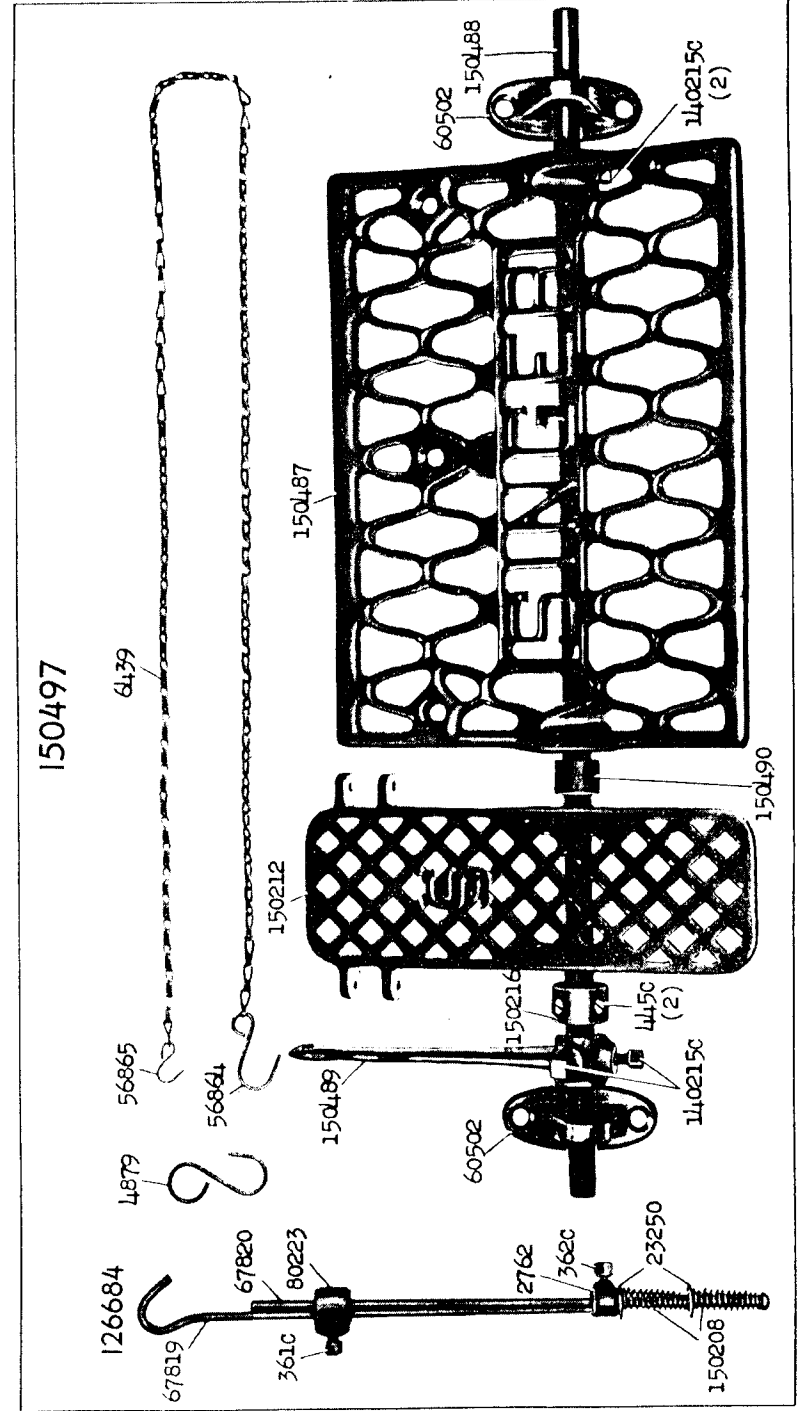
23086 - 1/2



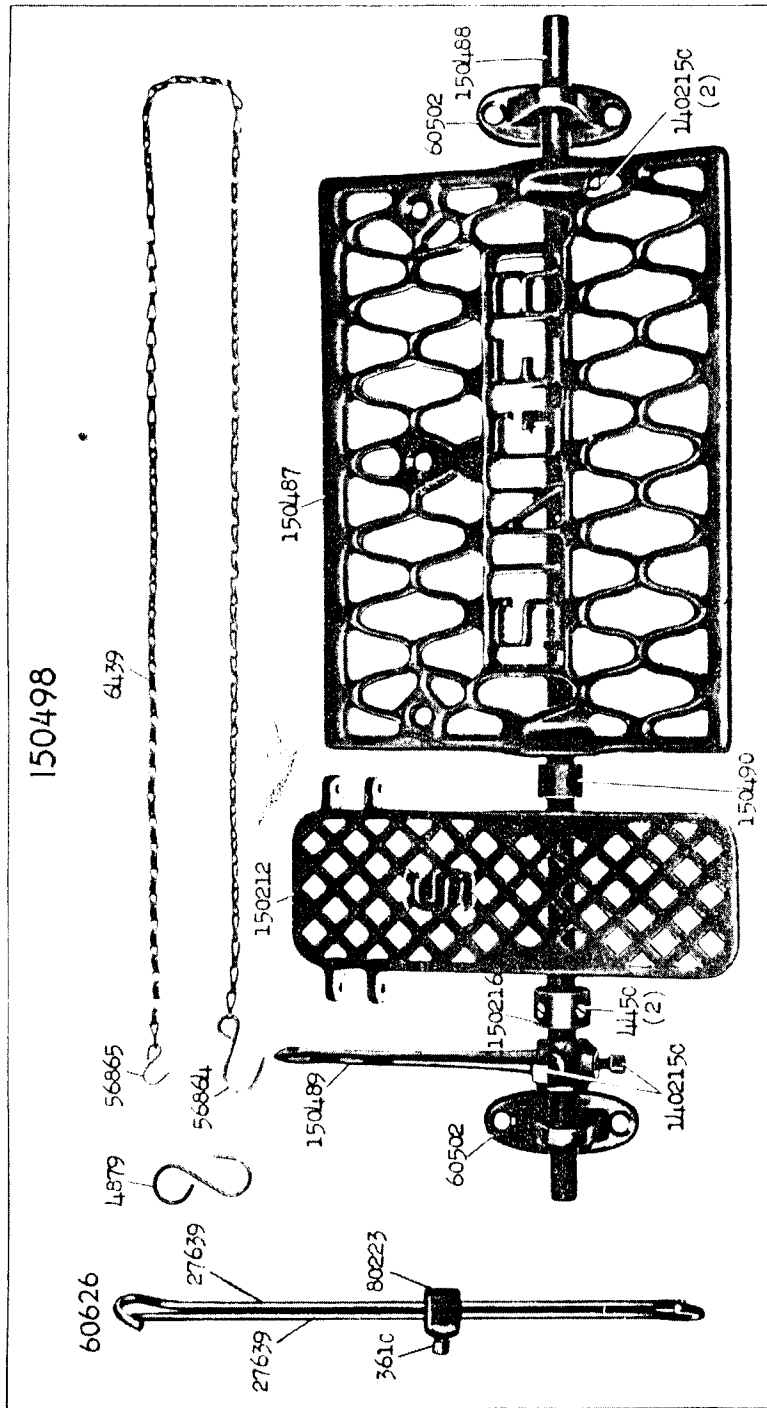
23087 - 1/4



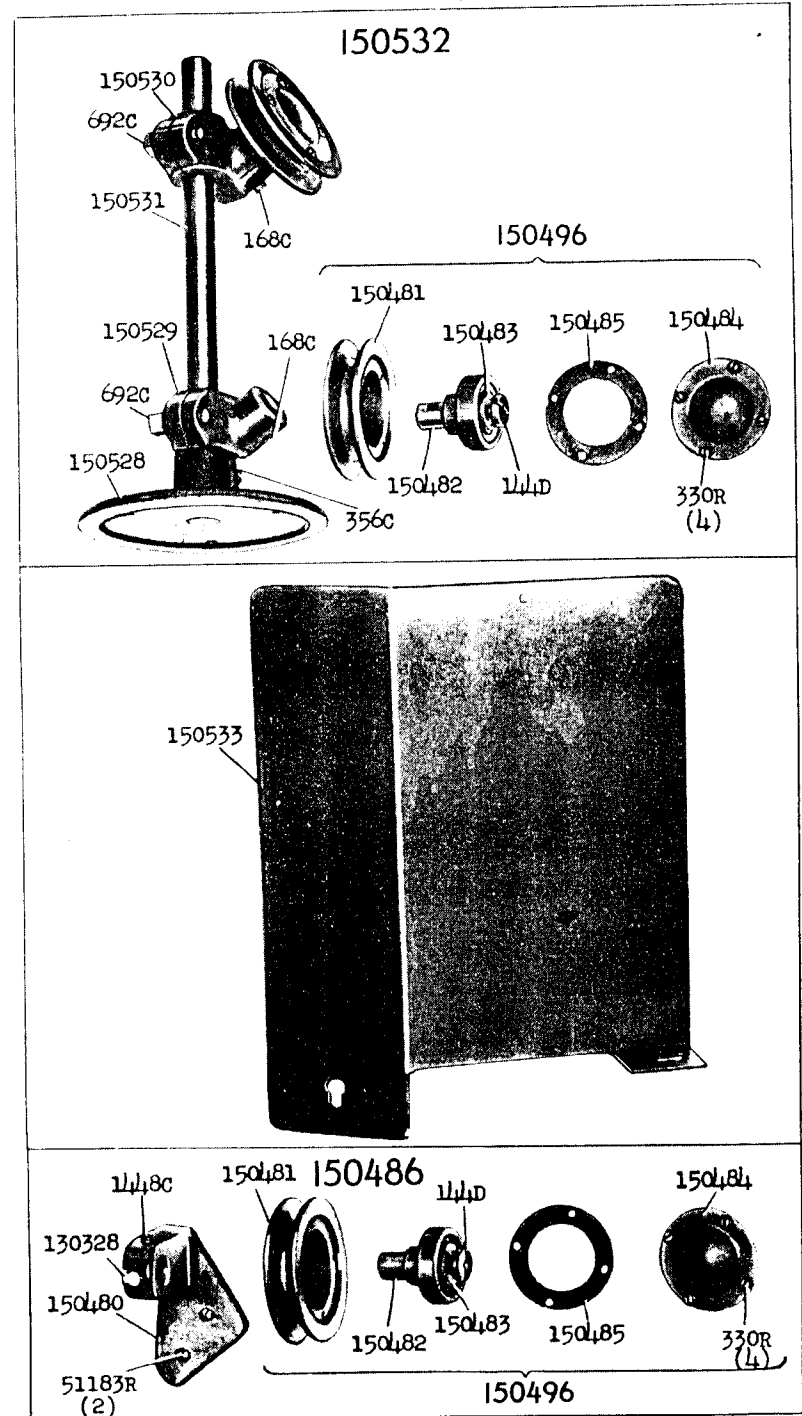
23088 - 1/4



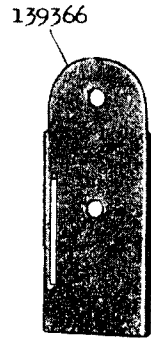
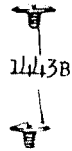
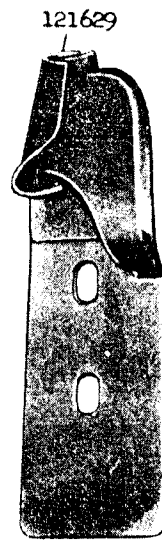
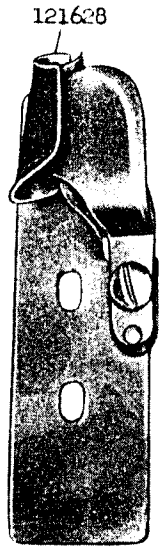
23089 - 1/4



23090 - 1/4

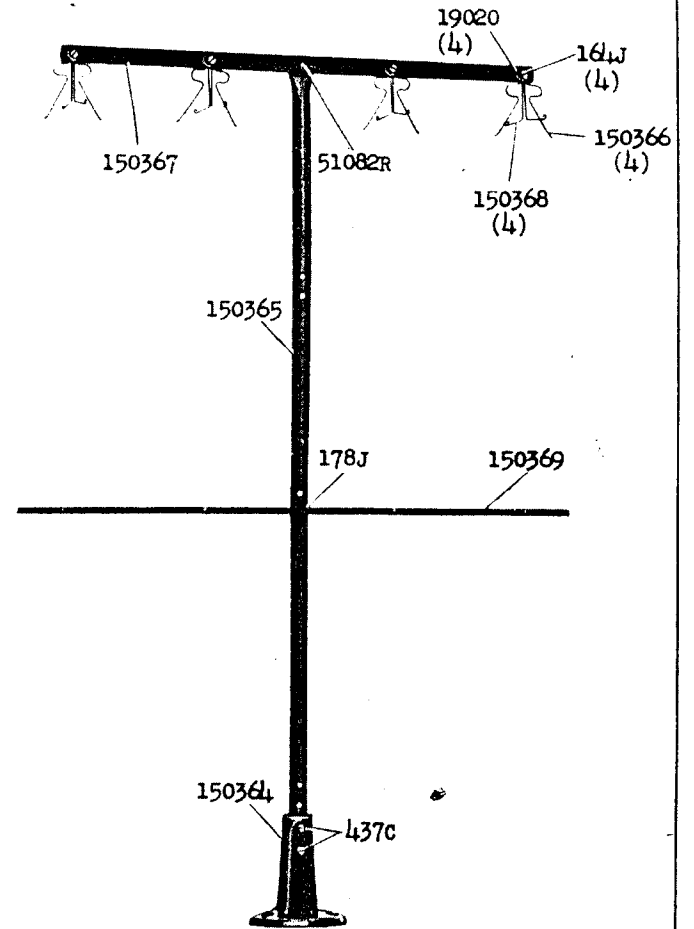


23091 - 2/3



23092 - 1/6

150370



150662

