

SINGER
300W101, 201, 401

USE SINGER* OILS and LUBRICANTS

They insure freedom from lubricating trouble and give longer life to sewing equipment

The following are the correct lubricants for this machine:

TYPE B — MANUFACTURING MACHINE OIL, HEAVY GRADE

When an oil is desired which will produce a minimum of stain on fabrics, even after a long period of storage, use:

TYPE D — MANUFACTURING MACHINE OIL, HEAVY GRADE

OTHER SINGER* LUBRICANTS

TYPE E — THREAD LUBRICANT

For lubricating the needle thread of sewing machines for stitching fabrics or leather where a thread lubricant is required.

TYPE F — MOTOR OIL

For oil lubricated motors and plain bearings in power tables and transmitters.

NOTE: All of the above oils are available in 1 quart, 1 gallon and 5 gallon cans.

GEAR LUBRICANT

This specially prepared grease is recommended for gear lubrication on manufacturing sewing machines.

BALL BEARING LUBRICANT

This pure grease is specially designed for the lubrication of ball bearings and ball thrust bearings of motors and electric transmitters, ball bearing hangers of power tables, etc. **Furnished in 1 lb. and 4 lb. tins.**

Form 2901w
Rev. (1261)

INSTRUCTIONS

FOR USING AND ADJUSTING

SINGER*

SEWING MACHINES

300w101, 300w201 and 300w401

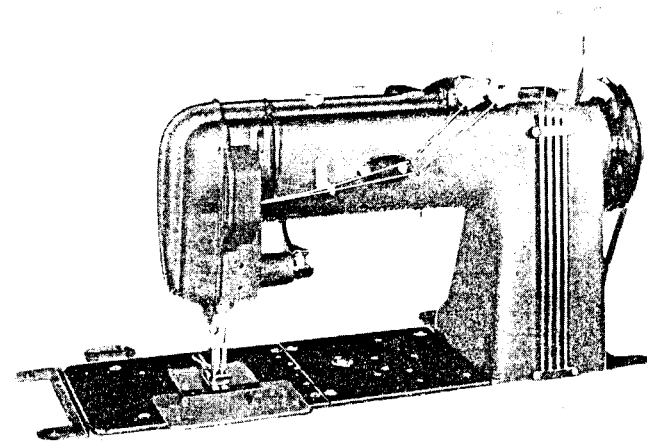

Special attention is called to the lubricating instructions on pages 6 and 7.

THE SINGER MANUFACTURING COMPANY

DESCRIPTION

Machine 300w101 has one needle and one looper and makes a single row of two-thread chain stitching.

Machine 300w201 has two needles and two loopers for simultaneously making two parallel rows of two-thread chain stitching. The needles are set abreast and the distance between them may be from $\frac{3}{16}$ inch to 2 inches, in steps of $\frac{1}{32}$ inch, as ordered.

Machine 300w401 is the same as 300w201 except that it has four needles and four loopers. The distance between outside needles may be from $\frac{3}{4}$ inch to 2 inches. The minimum distance between any two needles is $\frac{3}{16}$ inch.

These machines are especially adapted for attaching bibs to overalls, banding dungarees and work pants, elastic banding of shorts and swim trunks, stitching canvas goods, seat covers, and similar work in medium and heavy fabric.

A compound feed, consisting of a needle feed and a drop feed, carries the work forward in unison, insuring positive and even feeding of two or more plies of material.

An automatic oiling system delivers the required amount of oil to all of the principal bearings.

SPEED

The maximum speed recommended for these machines is 4500 R.P.M., depending upon the nature of the work. For the first few days, the speed of the machines should not exceed 4000 revolutions per minute, after which they can be driven at their maximum speed. The top of the machine pulley turns over toward the operator.

CAUTION: Before starting the machine, it must be thoroughly oiled as instructed on pages 6 and 7.

TO SET UP MACHINE

Assemble the iron work, legs, brackets, treadles, etc., as shown in Fig. 2.

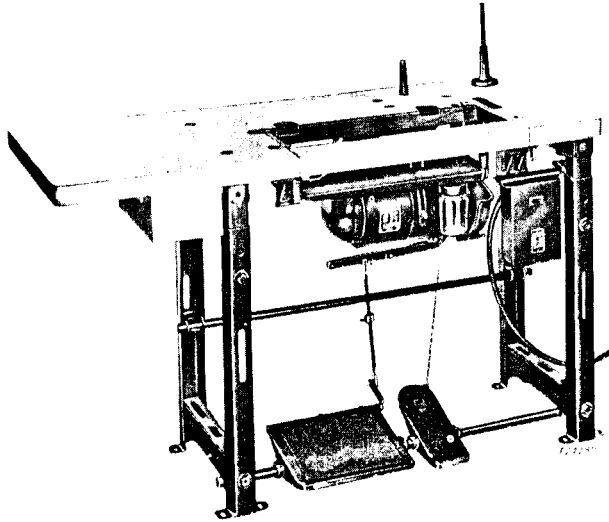

Fig. 2. Stand, Table and Electric Transmitter Assembled for Operation of Class 300w Machine
Assemble thread unwinder as shown in Fig. 3.

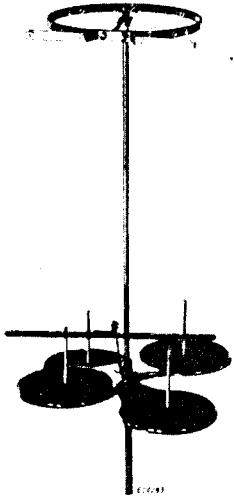

Fig. 3. Thread Unwinder Assembled

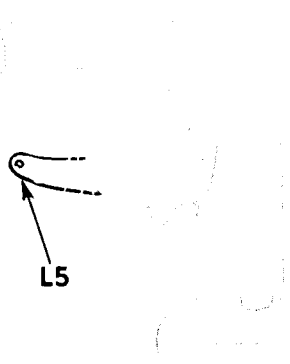

Fig. 4. Foot Lifter Lever

Connect foot lifter treadle to foot lifter lever L5, Fig. 4, at back of machine by means of chain furnished for purpose.

Assemble oil pan A to hangers B and insert in table as shown in Fig. 5. Attach oil jar to oil pan as shown in Fig. 2. Place four rubber bushings C in hanger holes as shown in Fig. 5.

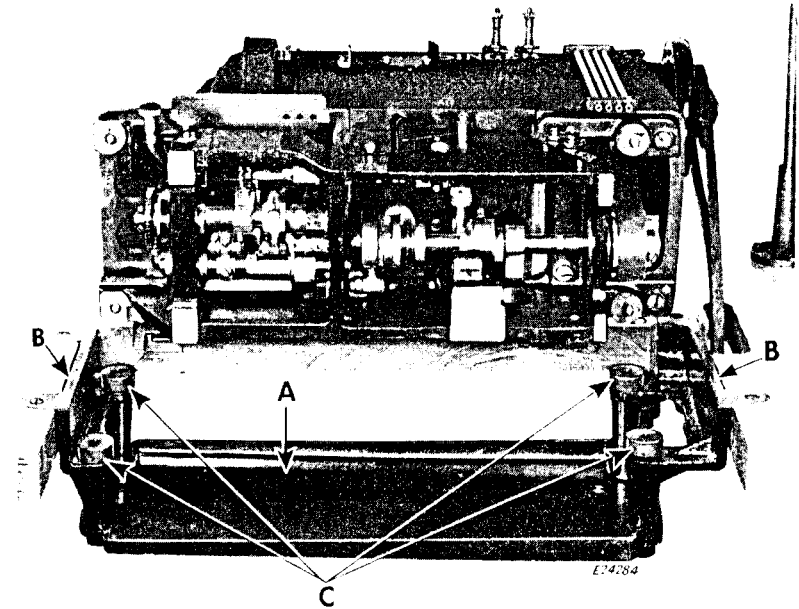

Fig. 5. Setting Up the Machine

TO OIL THE MACHINE

The machine has an efficient automatic oiling system comprising a hollow arm shaft and a hollow bed shaft which act as oil reservoirs and deliver the required amount of oil to all of the principal bearings when the machine is in operation. The oil is distributed to the various bearings by centrifugal force through small jets in the shafts so that only clean oil reaches the bearing surfaces. Oil holes are provided for hand oiling of parts in movable contact which are not oiled from the reservoirs.

CAUTION: Use "TYPE B" or "TYPE D" OIL sold by Singer Sewing Machine Company. For description of these oils see inside front cover of this book.

THE MACHINE MUST BE OILED AS INSTRUCTED BELOW AND ON THE FOLLOWING PAGE. FAILURE TO DO THIS WILL RESULT IN DAMAGE TO THE MACHINE.

Note: It is not necessary to remove the work plate for the first servicing or subsequent oiling of the machine. For this purpose, merely swing out the face plate and remove bed slide plate.

USE ONLY THE PRESSURE OIL CAN NO. 228491 FURNISHED WITH THE MACHINE, AS SHOWN IN FIG. 6.

TO OIL ARM SHAFT

1. To fill arm shaft reservoir, insert spout of pressure oil can in hole **D**, Fig. 6, and inject oil until oil appears around washer **E**, Fig. 7.

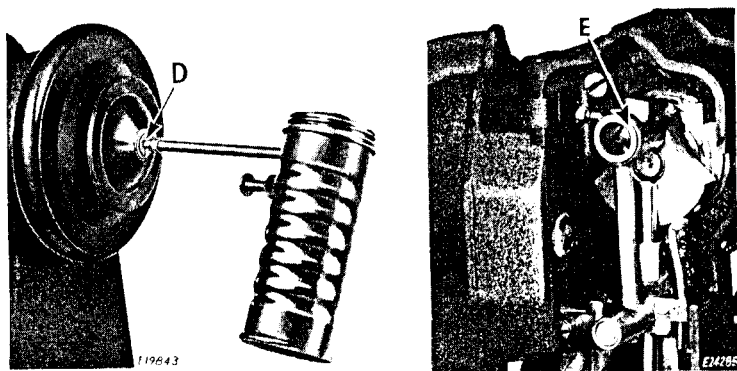
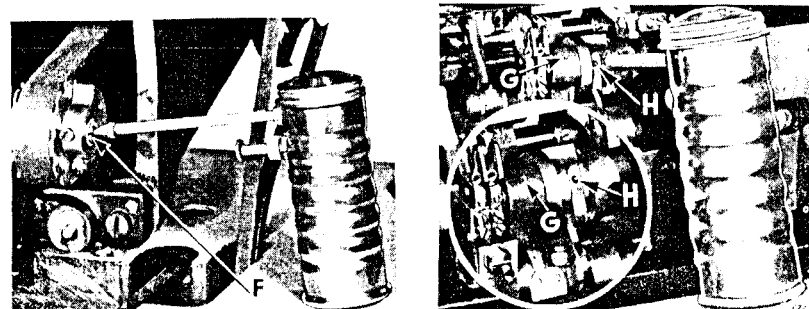

Fig. 6. Oil Hole for Arm Shaft
Oil Reservoir

Fig. 7

TO OIL BED SHAFT



Figs. 8 and 9. Oiling Bed Shaft

2. To fill bed shaft reservoir, open table section and tip machine back on its hinges, insert spout of pressure oil can in hole **F**, Fig. 8, and inject oil until oil appears at hole **G**, Fig. 9.

Return machine to its original position. Push spring cover **H**, Fig. 9 to the left and insert spout of pressure oil can in hole and inject oil until oil appears at hole **G**, Fig. 9.

CAUTION: Be sure to move spring cover **H**, Fig. 9, back to its original position to close oil hole before running machine.

3. Apply oil to work plate oil holes and arm oil holes. Oil needle bar bearings and connections, needle bar rock frame bearings, looper rocker sleeve, presser lifting mechanism and looper pull-out rack.

A MACHINE IN DAILY USE MUST BE OILED AS FOLLOWS:

Fill arm shaft oil reservoir **D**, Fig. 6 (approximately 6 shots of oil).

Fill bed shaft oil reservoir **G**, Fig. 9 (approximately 6 shots of oil).

Once a day Apply oil to all holes in work plate.

Oil needle bar bearings and connections and needle bar rock frame bearings.

Oil looper rocker sleeve.

Oil feed lifting rock shaft bearings in back of arm.

Occasionally oil tension release mechanism and looper pull-out rack.

TO THREAD THE LOOPERS

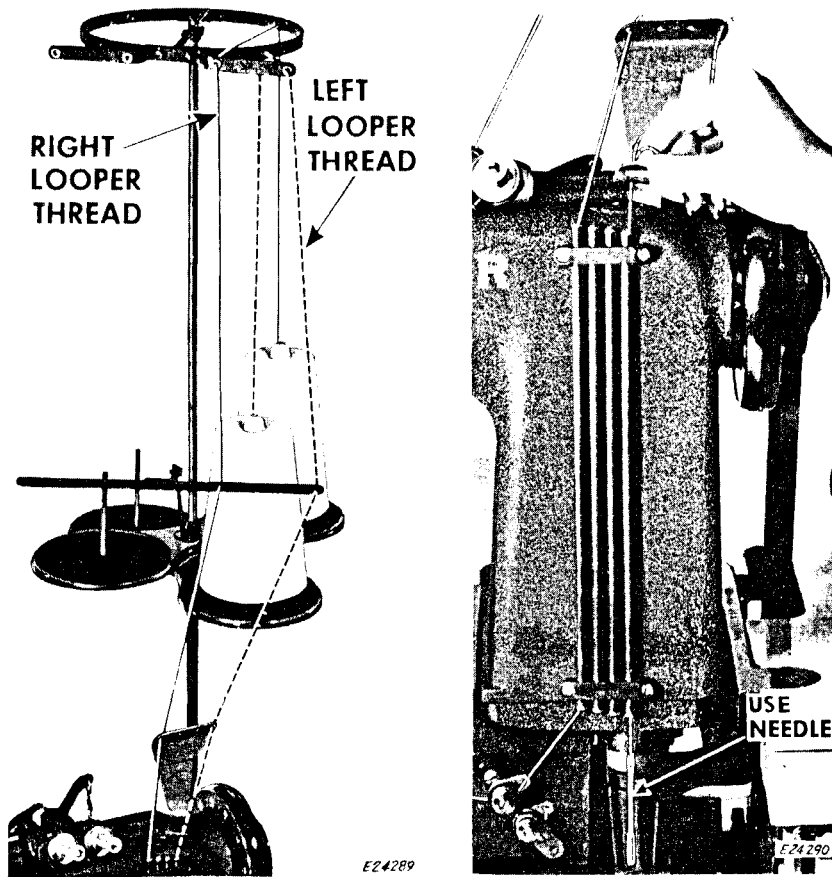

Fig. 10. Looper Threading

Fig. 11. Looper Threading

Open front table section and turn machine pulley over toward you until needle bar is at its highest position.

Move loopers out of sewing position by pulling rod **L5**, **Fig. 12**, out 1/4 inch and gear rack button **J**, **Fig. 12**, as far as it will go. This will make threading easier and prevent accidental operation of machine before loopers are returned to sewing position.

To thread loopers, pass threads through threading points in the order shown in **Figs. 10 to 14**. Dotted line indicates thread for left looper.

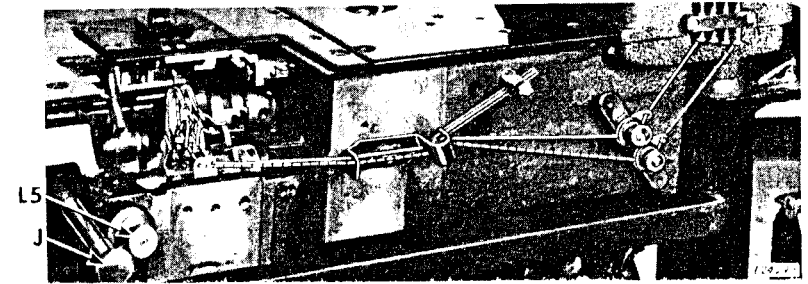

Fig. 12. Looper Threading



Figs. 13 and 14. Threading Looper

For threading loopers, use tweezers No. 228451, as shown in **Figs. 13 and 14**.

TO THREAD THE NEEDLES

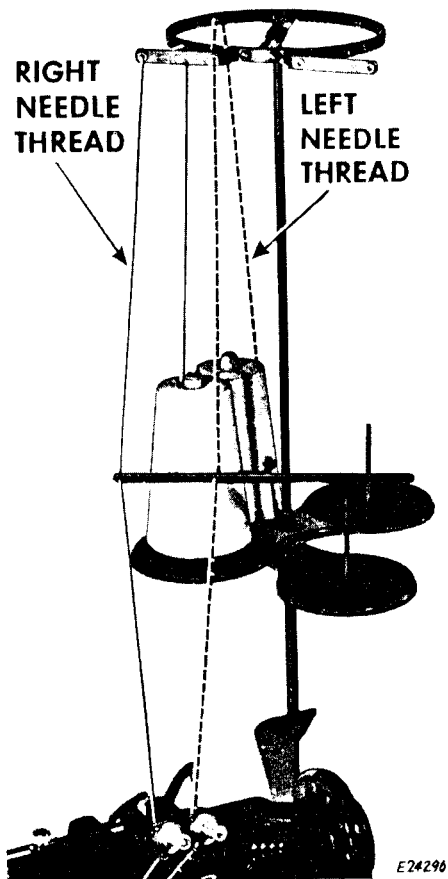

Fig. 15. Needle Threading

Turn machine pulley over toward you until needle bar is at its highest position.

To thread needles, pass thread through threading points in the order shown in Figs. 15 and 16. Dotted line indicates thread for left hand needle.

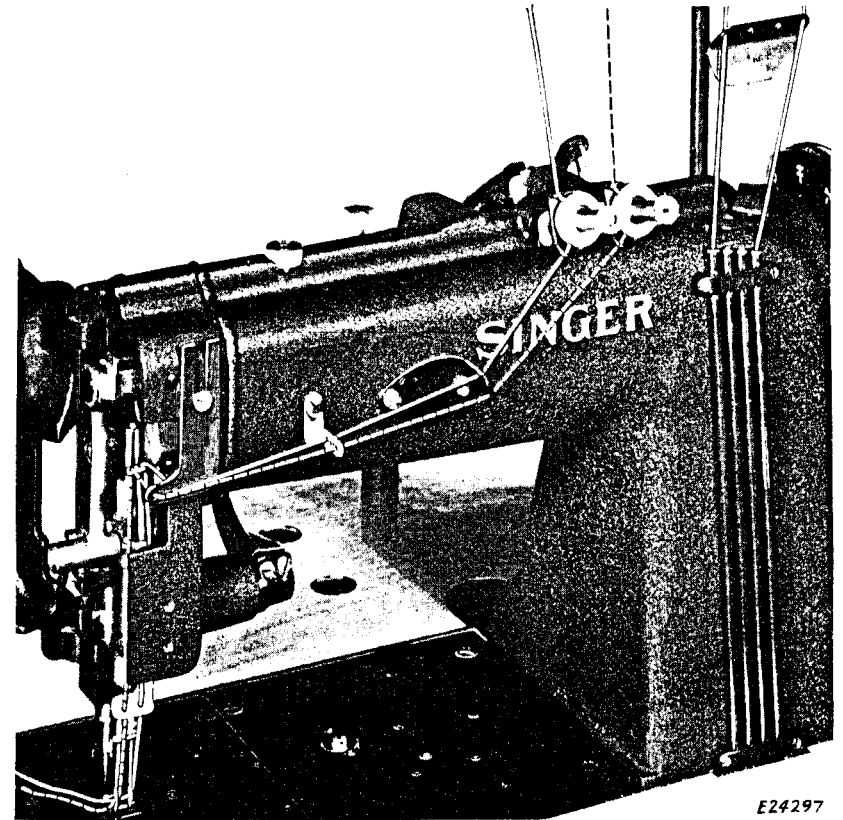

Fig. 16. Needle Threading

Draw about two inches of thread through eye of each needle with which to start sewing.

TO SET THE NEEDLES

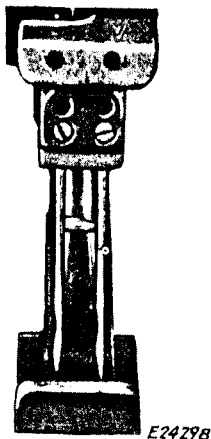

Fig. 17. Setting Needles

Insert the needles up into the needle clamp as far as they will go with the scarf of each needle toward the left, as shown in Fig. 17, then securely tighten the needle set screws.

NEEDLES

Needles for Machines of 300w are of Catalog 3260 (62 x 57) and are made in sizes 16, 17, 18, 19, 21, 22, 23 and 24.

Catalog 4112 (62 x 59) in sizes 22, 23 and 24, can also be used in these machines in which case the needle bar must be adjusted as instructed on page 21.

The size of the needle to be used is determined by the size of the thread which must pass freely through the eye of the needle. Rough or uneven thread, or thread which passes with difficulty through the eye of the needle will interfere with the proper operation of the machine.

Orders for needles must specify the quantity required, the size number, and the class and variety numbers separated by the letter X.

The following is an example of an intelligible order:

"100 No. 18, Catalog 3260 (62 x 57) Needles."

The best stitching results will be obtained with needles furnished by Singer Sewing Machine Company.

THREAD

Either left twist or right twist thread can be used in the needles and loopers.

TO REGULATE PRESSURE ON MATERIAL

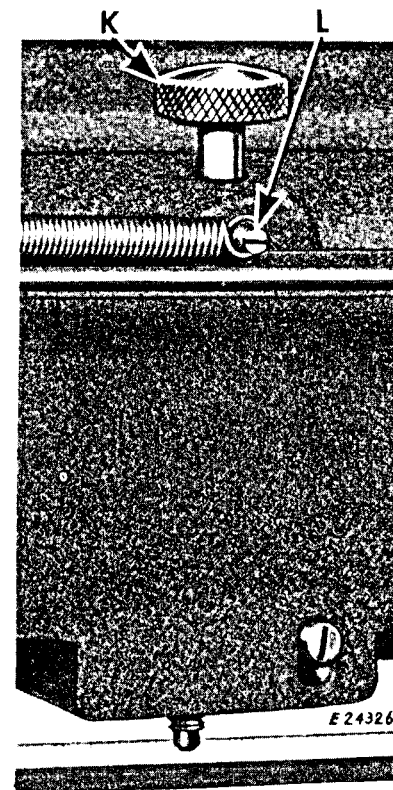

Fig. 18. Presser Bar Spring Pressure Regulator

The pressure of the presser foot on the material is regulated by means of the thumb screw K, Fig. 18, at the rear of the machine. Loosen the lock screw L, Fig. 18 and turn the thumb screw K downward to increase the pressure or upward to decrease the pressure. When the correct feeding pressure is attained, tighten the lock screw L to retain the adjustment.

TO REGULATE TENSIONS

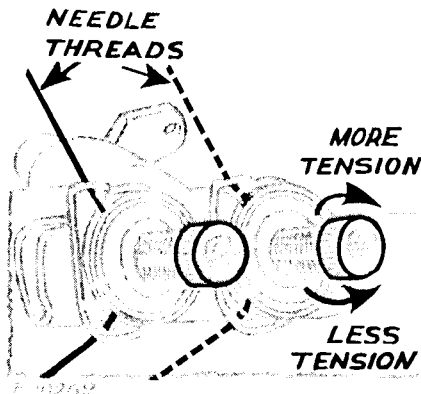

Fig. 19

For average sewing, the tension on the looper threads should be very light.

Tension should be just enough to set the stitch properly in the material.

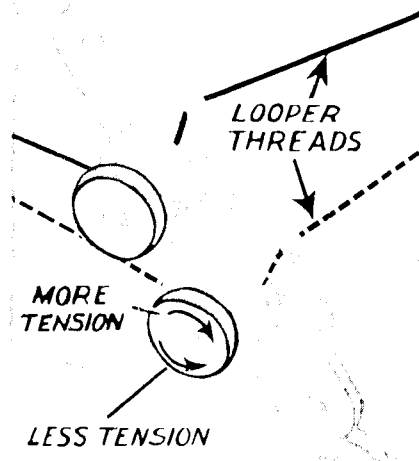

Fig. 20

TO REGULATE THE LENGTH OF STITCH

The letters A to L on the stitch indicator plate M, Fig. 21 denote the various lengths of stitches that can be made, the letter A indicating the longest stitch. The letter opposite the arrow N, Fig. 21 on the front of the arm indicates the length of stitch the machine is ready to make when the plunger O, Fig. 22 and button P, Fig. 22 engage the notches in the feed eccentrics.

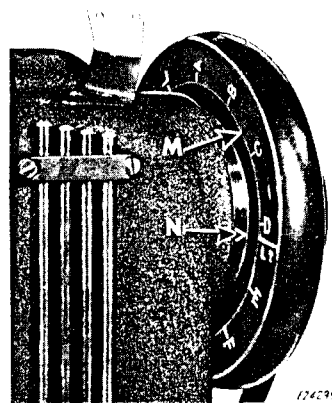
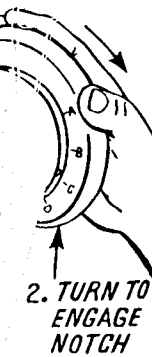
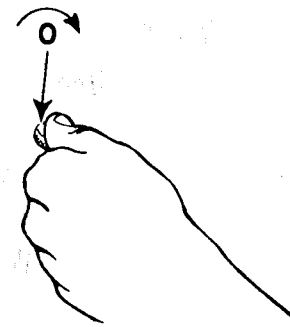

Fig. 21. Stitch Indicator

1. PRESS PLUNGER O
3. WHEN IN NOTCH, TWIST CLOCKWISE ¼ TURN



2. TURN TO ENGAGE NOTCH

4. PRESS TO ENGAGE NOTCH



5. TURN WHEEL

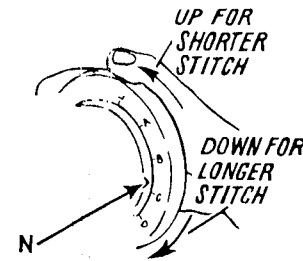

Fig. 22. Adjustments for Changing Length of Stitch

The forward and backward movements of the needles are regulated by the knurled plunger O. The travel of the feed dog is regulated by the button P.

When changing the length of stitch, the following adjustments must be made in UNISON.

Press in plunger O and at the same time turn machine pulley over toward you until plunger O enters a notch in adjustable eccentric on arm shaft, then turn plunger clockwise to lock it in position. Now, press button P and at the same time turn machine pulley over toward you to increase length of stitch or over from you to shorten stitch, until desired letter on stitch indicator is opposite arrow N. Then release button P and TURN plunger O to right or left until it springs outwardly and releases eccentric. The machine is then ready for operation.

CAUTION: NEVER change forward and backward movements of needles without changing the travel of the feed dog.

The needles and feed dog are usually set to act synchronously, but this setting is subject to slight variations depending upon the nature of work being sewn.

NOTE: The instructions on the following pages are for Adjusters and Mechanics only.

TO SET FEED BAR AT THE CORRECT HEIGHT

See that feed lift crank timing screw **Q**, **Fig. 23** engages shaft spot correctly and that slot of feed lift link clamp **R** is properly aligned with rock shaft timing flat. If an adjustment is required, loosen clamp screw **S**, move feed lift link to correct position, see that it is not binding sidewise, then securely tighten clamp screw **S**.

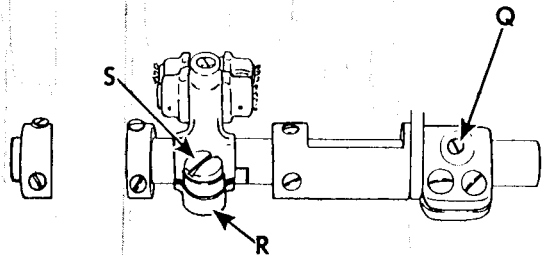

Fig. 23. Adjustment for Setting Feed Bar at Correct Height

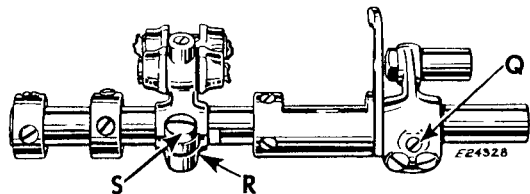

Fig. 24. Feed Lift Crank and Link Assembly

TO SET FEED DOG SIDewise IN RELATION TO NEEDLES

Loosen feed dog screws **T**, **Fig. 25** and move feed dog sidewise on shank until needles will enter center of needle holes, then re-tighten screws.

If additional sidewise adjustment is required, loosen screws **U**, **V**, **W**, and **X**, **Fig. 25**, and feed lifting crank clamping screw **S**, **Fig. 23**, and move feed rocker and feed bar assembly to required position and re-tighten. Be sure link **Z** and strap **A1**, do not bind.

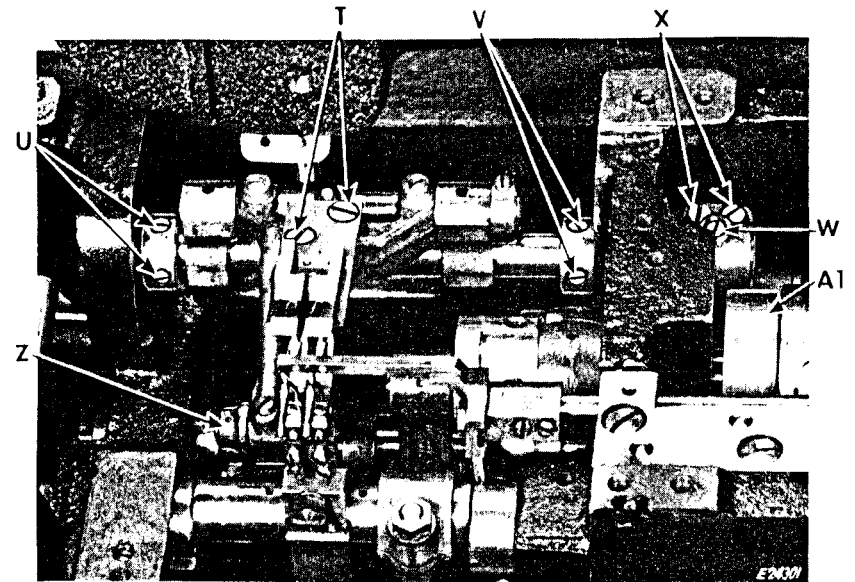

Fig. 25. Adjustments for Setting Feed Dog
Sidewise in Relation to Needles

TO SET FEED DOG FORWARD AND BACKWARD IN RELATION TO SLOTS IN THROAT PLATE

To adjust feed dog in direction of feed after feed dog has been positioned sidewise in relation to needles, set feed eccentric **D2**, Fig. 26 for desired stitch length. Loosen set screw **W**, Fig. 26 and two clamp screws **X**, Fig. 26 in feed driving rock shaft crank and move feed rocker **D3**, Fig. 26 forward or backward until feed dog clears ends of feed slots in throat plate equally at both ends of feed travel. Tighten two clamp screws **X**, Fig. 26, and lock them with set screw **W**, Fig. 26.

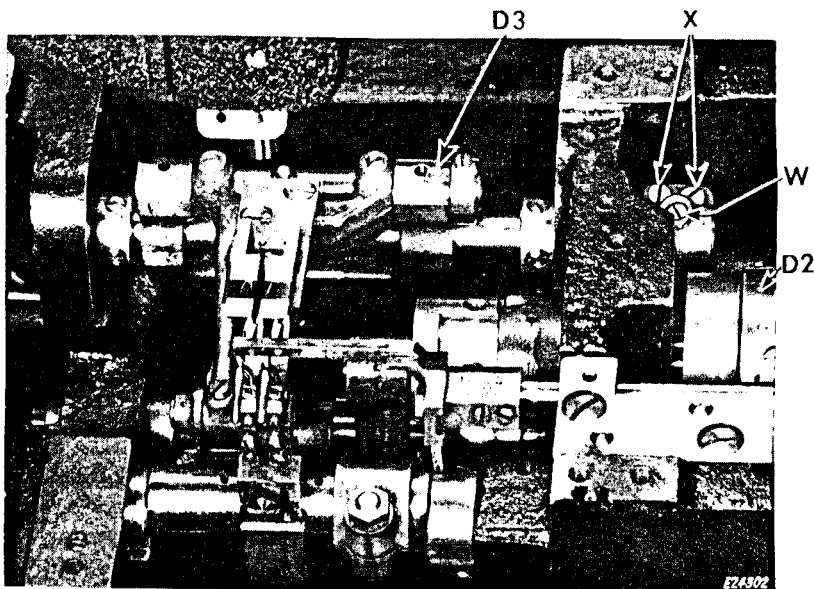

Fig. 26. Adjustments for Setting Feed Dog Forward and Backward
in Relation to Slots in Throat Plate

TO SET FEED DOG AT CORRECT HEIGHT

When feed dog is at its highest position, approximately full depth of teeth should show above the throat plate. To raise or lower feed dog, loosen lock nuts **E2** and **F2**, Fig. 27 and slightly loosen feed dog clamping screw **G2**. To raise feed dog turn jack screw **H2** clockwise, to lower feed dog turn jack screw **H2** counter-clockwise and tap feed dog down. When feed dog is correctly set, securely tighten clamping screw **G2** and lock nuts **E2** and **F2**.

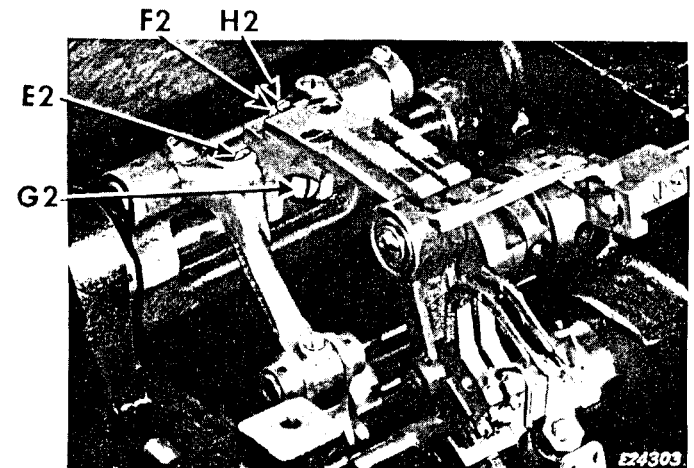

Fig. 27. Adjustments for Setting Feed Dog at Correct Height

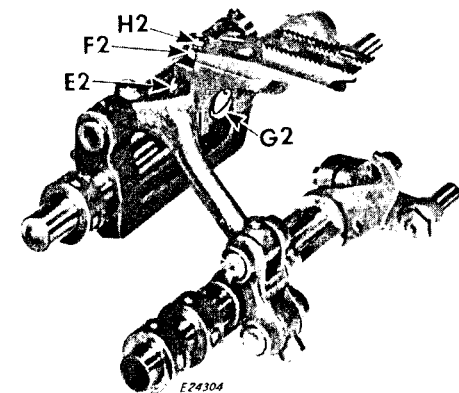

Fig. 28. Adjustments for Setting Feed Dog at Correct Height

TO TIME FEED LIFT ECCENTRIC

The feed lifting eccentric is not spotted. To adjust, insert screw-driver in hole in feed lift strap, slightly loosen screws at **J2**, **Fig. 29** and move feed lift eccentric forward to make feed dog rise earlier, or backward for later. When feed dog is at its highest position, the top of teeth should be parallel with upper surface of throat plate and project full depth of teeth above throat plate, then securely tighten screws at **J2**.

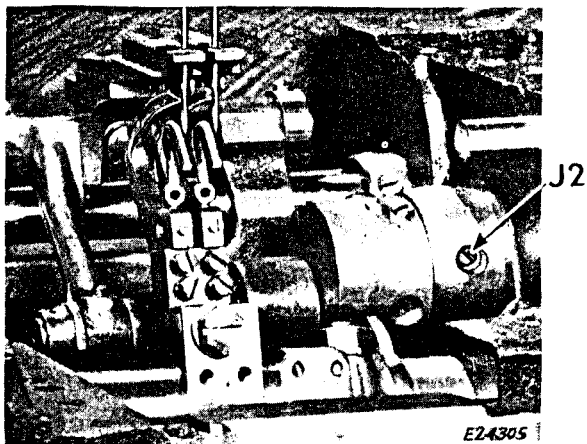

Fig. 29. Adjustment for Timing Feed Lift Eccentric

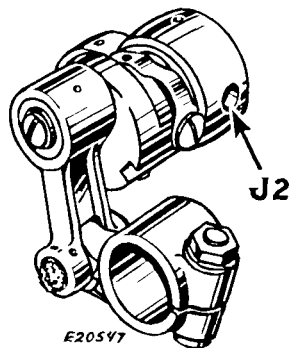

Fig. 30. Feed Lift Eccentric

TO POSITION NEEDLE BAR FORWARD OR BACKWARD IN RELATION TO FEED DOG

Insert 62 x 57 needles (or x 57 for heavy seams) in needle holder as far as they will go, then securely tighten screws. Set stitch regulators **J3** and **K2**, **Fig. 31** to desired stitch length. Press needle bar rock frame **L2** against drive arm, at same time loosening screws **M2** as shown in **Fig. 32**. Continue holding needle bar rock frame while positioning needles in needle holes of feed dog.

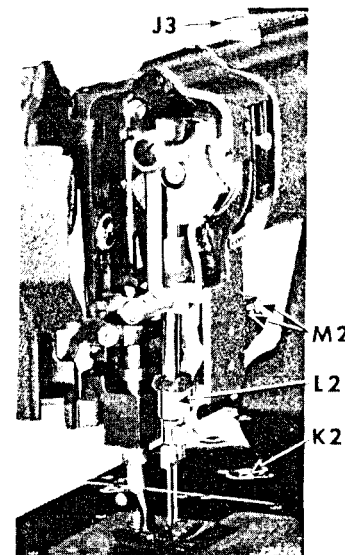

Fig. 31.

Needles should enter needle holes of feed dog toward the front with approximately the same clearance between the front of the needles and the needle holes as at the side.

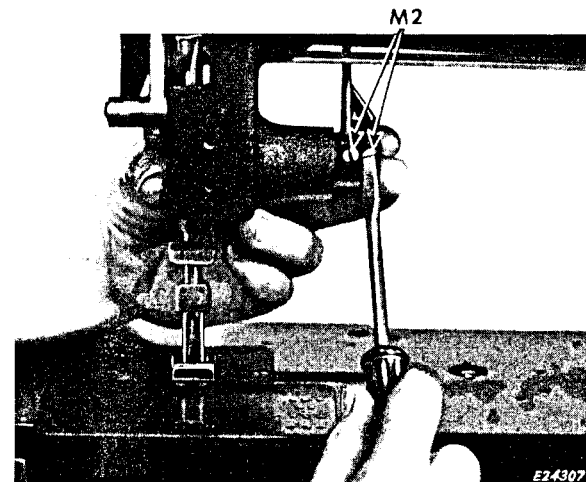

Fig. 32. Adjustments for Positioning Needle Bar Forward and Backward in Relation to Feed Dog

CAUTION: Before releasing pressure on needle bar rock frame against drive arm, tighten screws **M2**.

TO POSITION LOOPERS SIDewise IN RELATION TO THE NEEDLES

Insert loopers in the looper holder as far down as they will go. Position loopers at a slight angle so that the back or heel of the loopers are slightly to the left. Turn machine pulley until the points of the loopers are directly opposite the center of the needles. Loosen screw **02**, **Fig. 33** and tap looper holder **P2** to right or left so the points of the loopers just clear the scarfs of the needles on the forward stroke of the loopers. When in correct position, securely tighten screw **02**.

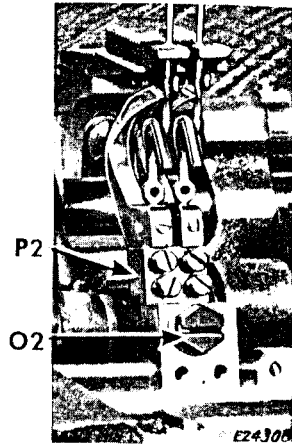

Fig. 33. Adjustments for Positioning Loopers Sidewise in Relation to the Needles

APPROX. 1/16"

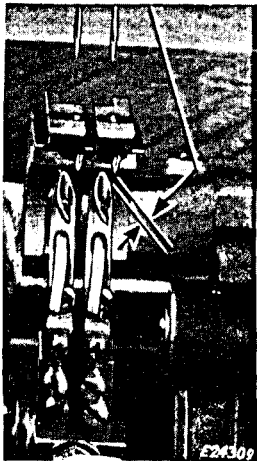

Fig. 34. Showing Correct Clearance between Heel of Looper and Loop Deflector

When loopers are in extreme forward position, check clearance between heel of looper and loop deflector as shown in **Fig. 34**. Approximately 1/16 inch clearance should be allowed.

TO TIME LOOPER DRIVING CRANK

Turn the machine pulley over toward you and at the same time note the distance above the eye of the needle at which the looper point passes the needle on both the forward and backward stroke of the looper.

If the point of the looper passes higher above the eye on the forward stroke than on the backward stroke, loosen looper driving crank set screw **Q2**, **Fig. 35**, next loosen looper crank timing screw **R2** approximately 1/8 turn and tighten timing screw **S2**. Re-check distance that point of looper passes above eye of needle.

Continue to adjust timing screw until point of looper passes the same distance above the eye of needle on both the forward and backward stroke of the looper.

If the point of the looper passes higher on the backward stroke than on the forward stroke, reverse the adjustment described above, i.e., loosen timing screw **S2** and tighten screw **R2** until point of looper passes same distance above eye of needle on both forward and backward stroke of looper.

After crank is correctly timed, securely tighten set screw **Q2**.

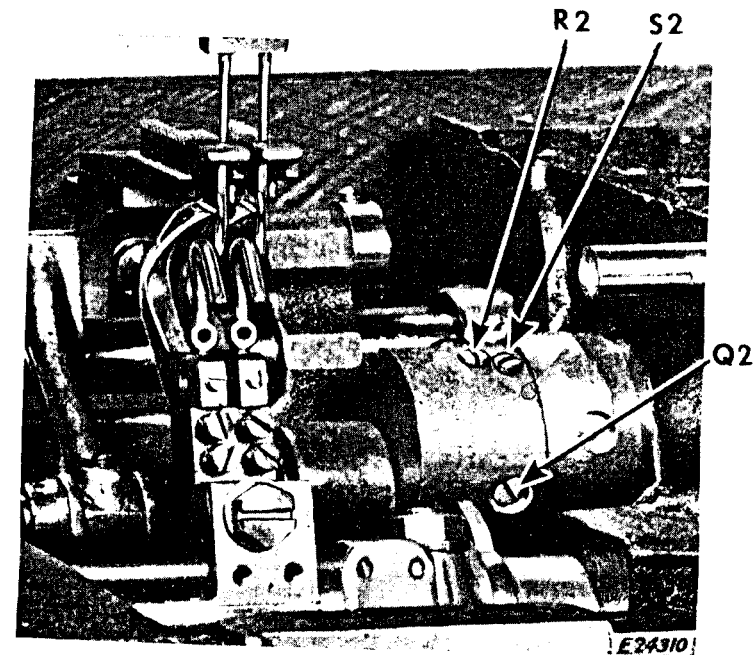

Fig. 35. Adjustments for Timing Looper Driving Shank

TO POSITION LOOPERS FORWARD OR BACKWARD IN RELATION TO NEEDLES, AND TO SET HEIGHT OF NEEDLE BAR

Turn machine pulley until looper timing mark LT on machine pulley is opposite arrow **N**, **Fig. 36**. Loosen looper carrier clamping nut **T2**, **Fig. 37**, and move looper carrier forward or backward until points of looper are directly opposite center of needles, as shown in **Fig. 37**, then securely tighten clamping nut.

While loopers and machine pulley are in this position, loosen needle bar clamping screws **U2**, **Fig. 38** and position needle bar so that points of loopers are at the center of the clearance above the eyes of the needles as shown in **Fig. 37**. Securely tighten clamping screws.

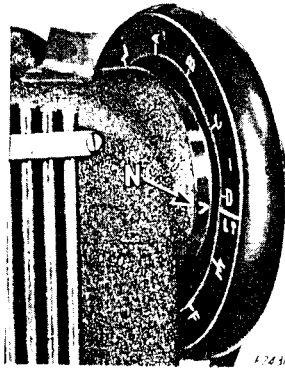

Fig. 36. Looper Timing Mark LT

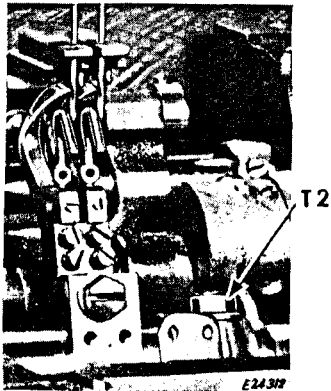

Fig. 37. Adjustments for Positioning Loopers Forward or Backward in Relation to Needles

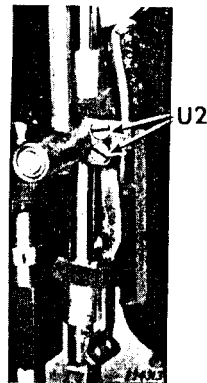

Fig. 38. Adjustments for Setting Height of Needle Bar

TO SET THE NEEDLE GUARDS IN RELATION TO THE NEEDLES

Turn machine pulley until the points of the loopers are about to pass the needles on their forward stroke.

Looper timing mark LT on machine pulley will be about 1/8 inch above arrow. Loosen needle guard set screws **V2**, **Fig. 39** and turn needle guards **W2** as close to the needles as possible without rubbing. Tighten needle guard set screws and check by springing the needles to the left and turning machine pulley to make sure the looper points cannot stroke the needles.

Keep needle guards below the eyes of the needle so they do not interfere with the needle thread when sewing.

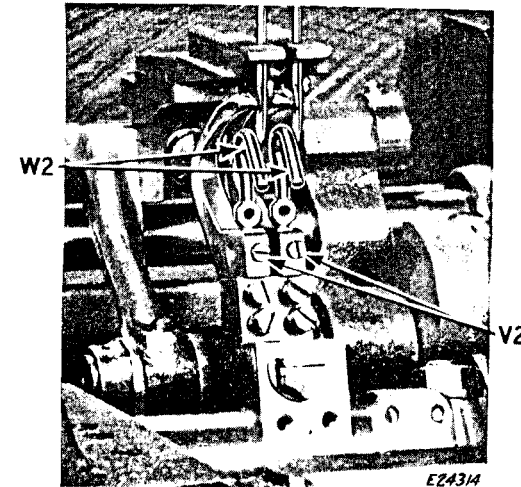

Fig. 39. Adjustments for Setting Needle Guards in Relation to the Needles

TO POSITION LOOP DEFLECTORS IN RELATION TO NEEDLES

To position loop deflectors in relation to needles, open hinged table section and tip machine back on its hinges as shown in Fig. 5, Page 5.

Move loopers out of sewing position as described on Page 8, insert screwdriver through bottom of machine and loosen loop deflector screws X2, Fig. 40 on underside of feed dog and push loop deflectors as far toward the rear of the feed dog as the screw slots will allow. Tighten screws lightly to allow further adjustment. Return loopers to sewing position and turn machine pulley until needles have descended to the bottom of

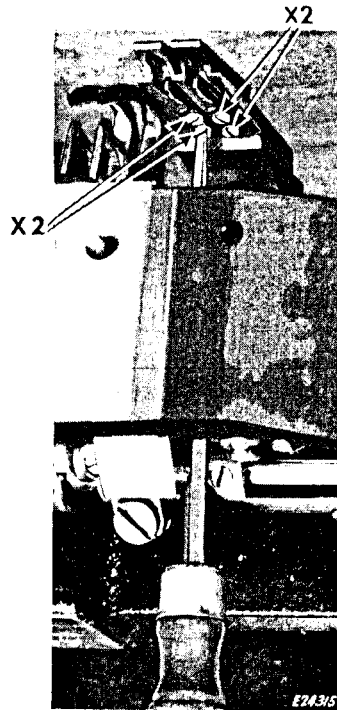

Fig. 40. Adjustments for Positioning Loop Deflectors in Relation to Needles

the needle bar stroke. Tap loop deflectors to the right or left to obtain about 1/32 inch clearance between the right side of the needles and the loop deflectors Fig. 41, throw loopers out of sewing position and tighten loop deflector screws securely.

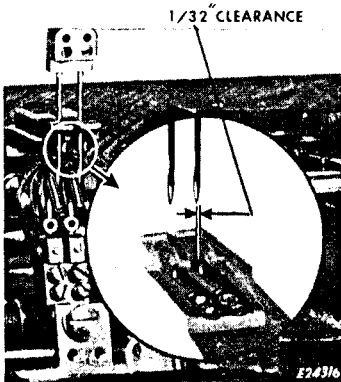

Fig. 41. Showing Correct Clearance between Right Side of Needles and Loop Deflectors

TO REMOVE LOOPER CARRIER ASSEMBLY

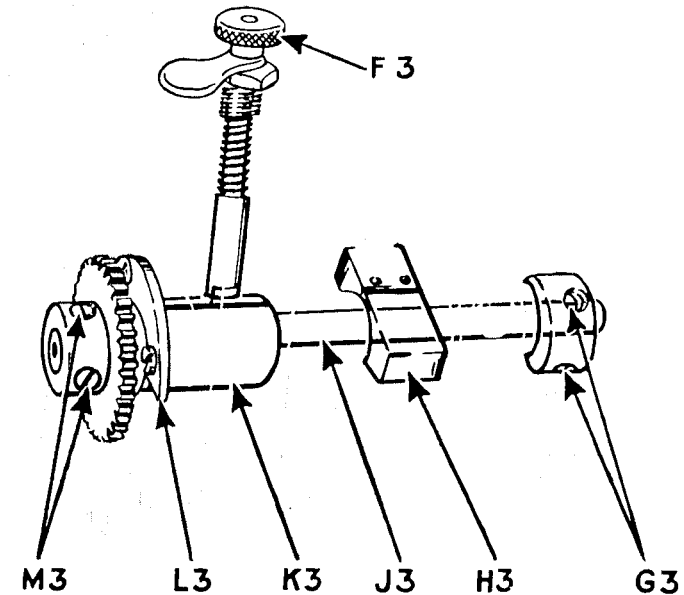

Fig. 42. To Remove Looper Carrier Assembly

Loosen screws M3, Fig. 42 in rack gear, remove gear and thrust plate L3. Loosen screws in right hand looper rocker bushing G3 and pull out left hand looper rocker bushing K3 and shaft, holding latch pin F3 out of engagement while removing bushing K3. The looper rocker H3, and driving member can then be removed.

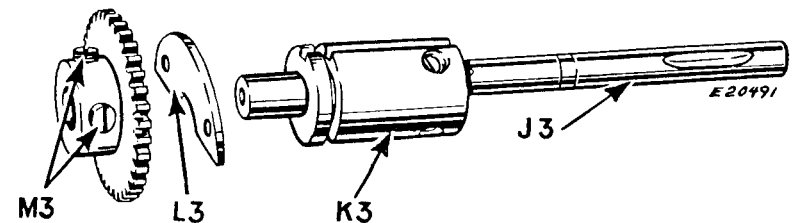

Fig. 43. Looper Carrier Assembly

TO SET SPREADER SIDEWISE IN RELATION TO LOOPERS

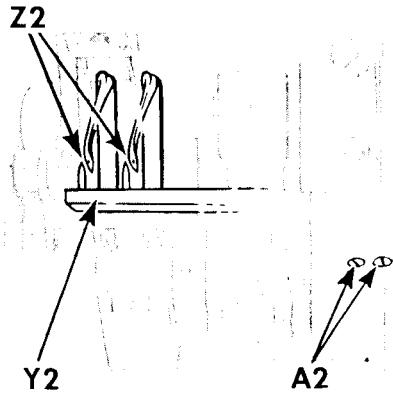

Fig. 44. Spreader Set Sidewise in Correct Relation to Loopers

When loopers are passing spreader points on their forward stroke, spreader Y2, Fig. 44 must clear loopers by a double thickness of ordinary paper at Z2. If spreader is too far away or too close to loopers, loosen two screws A2 in spreader holder and move spreader and holder sidewise in required direction. Be careful not to tip spreader up or down when moving it sidewise, as

this will change loop casting-off position. When spreader is correctly set, tighten screws A2.

TO SET SPREADER FORWARD OR BACKWARD IN RELATION TO NEEDLES

With machine set at desired stitch length, turn machine pulley over toward you until points of needles have descended to the same level as the points of the spreader, as shown in Fig. 45. With needles in this position, distance between needles and spreader points should be approximately 1/16 inch. To make this adjustment, loosen screw B2, Fig. 45 and move spreader Y2 to required position and re-tighten screw B2.

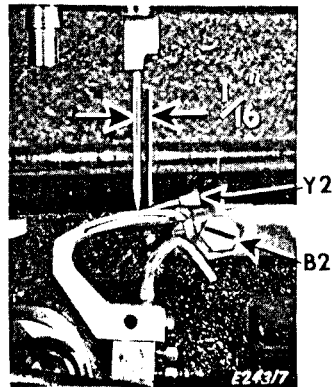

Fig. 45. Adjustments for Setting Spreader Forward or Backward in Relation to Needles

TO SET SPREADER POINTS AT CORRECT HEIGHT IN RELATION TO LOOPERS

Loosen two screws A2, Fig. 46, tilt spreader holder so that points of spreader are exactly opposite top of thread groove at side of loopers while passing on forward stroke of loopers. Tighten screws A2.

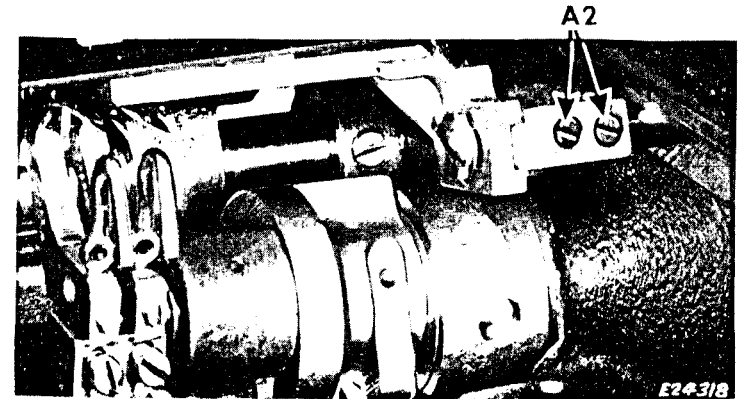
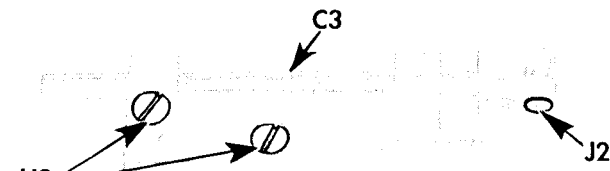

Fig. 46. Adjustments for Setting Spreader Points at Correct Height in Relation to Loopers

TO REMOVE SPREADER SHAFT



1. LOOSEN SCREWS H2
2. REMOVE BRACKET WITH SHAFT C3 AND DRIVE PIN J2

Fig. 47. Spreader Shaft and Bracket

TO CHANGE AMOUNT OF SIDEWISE MOVEMENT OF SPREADER

With the machine tipped back on its hinges, loosen two spreader driving eccentric screws **C2**, Fig. 48 and two spreader driving eccentric flange screws **D2**, Fig. 48, and move eccentric to left to increase movement or to right to decrease movement. When in correct position, tighten screws **C2**, first, then hold flange **E2** against strap **F2** to take out any lost motion, then securely tighten screws **D2**. Maximum spreader movement is normally used. After setting, check machine for any bind.

CAUTION: When increasing sidewise movement, allow sufficient clearance between spreader driving rock shaft **G2** and left side of eccentric ball strap **F2**, so they cannot touch when eccentric ball stud is in its highest position.

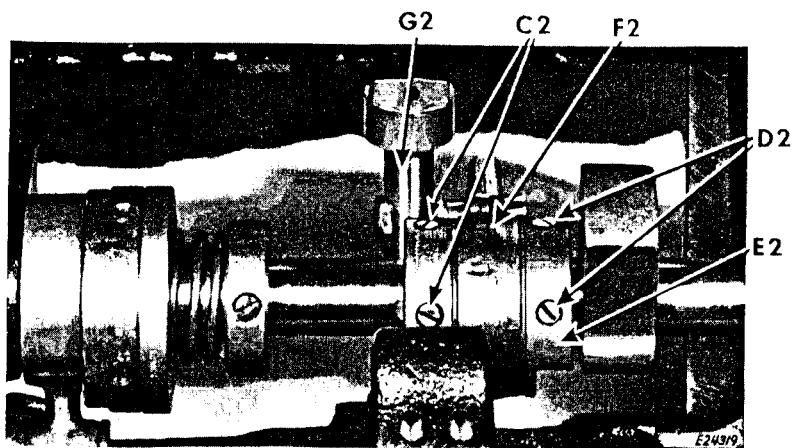

Fig. 48. Adjustments for Changing Amount of Sidewise Movement of Spreader

TO SET THE NEEDLE THREAD TAKE-UP

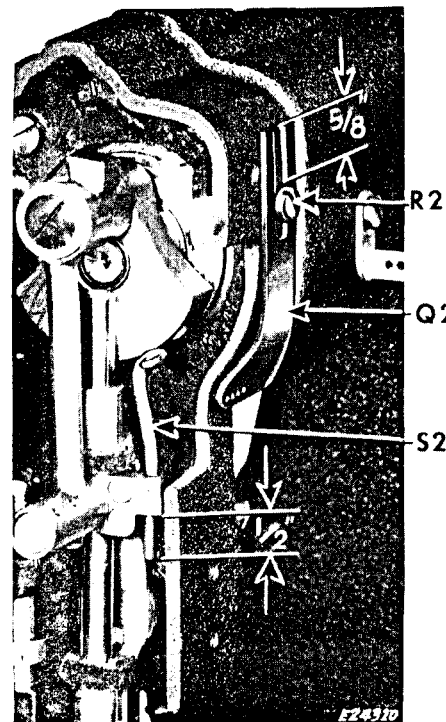

Fig. 49. Adjustments for Setting Needle Thread Take-Up

For average sewing conditions, set needle thread guide **Q2**, Fig. 49 with upper end $\frac{5}{8}$ inch above head of screw **R2**. Set needle thread take-up **S2**, Fig. 49 with lower end $\frac{1}{2}$ inch below bottom of its holder. It is generally advisable to draw the majority of the needle thread through the tension at the top of the needle bar stroke.

To increase the amount of thread drawn at the top of the needle bar stroke, raise thread take-up **S2** or lower thread guide **Q2**. To decrease the amount, reverse the adjustment by either lowering thread take-up **S2** or raising thread guide **Q2**.

TO ADJUST NEEDLE THREAD TENSION RELEASER

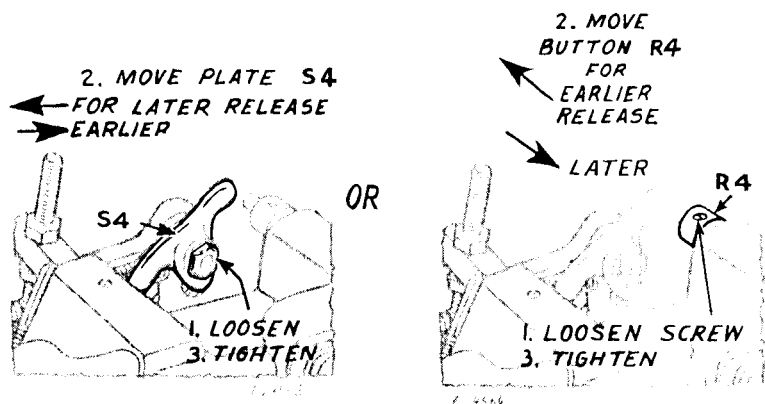

Fig. 50. Adjustments on Needle Thread Tension Releaser

The function of tension releaser is to release tension on needle threads when presser feet are raised. If tension releaser does not release threads when presser foot is raised, or if tension is partially released when presser foot is down, move button **R4**, Fig. 50 in or out on its holding stem to open tension more or less, or if necessary, move tension releaser plate **S4** sidewise to release tension at correct time.

TO ADJUST LOOPER THREAD TAKE-UP

The looper thread take-up has two adjustments, sidewise for handling more or less thread according to the thickness of material and length of stitch, and by tilting the thread guide **V2**, Fig. 51 to change the ratio of looper thread in the finished stitch.

To change the amount of thread handled, loosen screws **X2** and **Y2** and move looper thread guide **V2** and looper thread take-up rod **W2** to the left for more thread or to the right for less. Be sure the end of the take-up rod **W2** passes through the center of the yoke of thread guide **V2**. To change the amount of looper thread in the finished stitch, loosen screw **X2** and lower the yoke or right end of thread guide **V2** for more looper thread or raise the yoke for less thread.

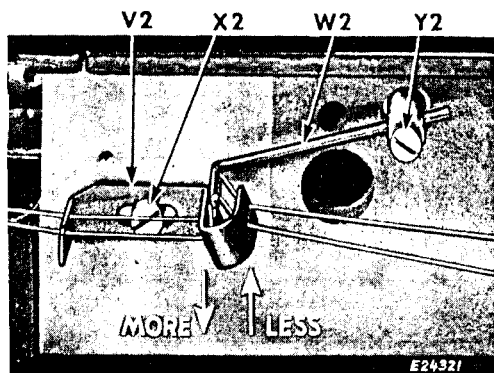

Fig. 51. Adjustments on Looper Thread Take-Up

INSTRUCTIONS FOR ADJUSTING SINGER* MACHINES OF CLASS 300w

EQUIPPED WITH PULLER FEED

TO ADJUST THE PULLER FEED

The puller feed is set at the factory to feed the material slightly faster than the compound feed of the machine so that the pulling action of the feed rolls will produce a slight tension on the material between the compound feed and the puller feed rolls.

The puller feed is actuated by an eccentric on the bed shaft and the amount of its feeding movement is automatically regulated in relation to the compound feed when changing the length of stitch as instructed below:

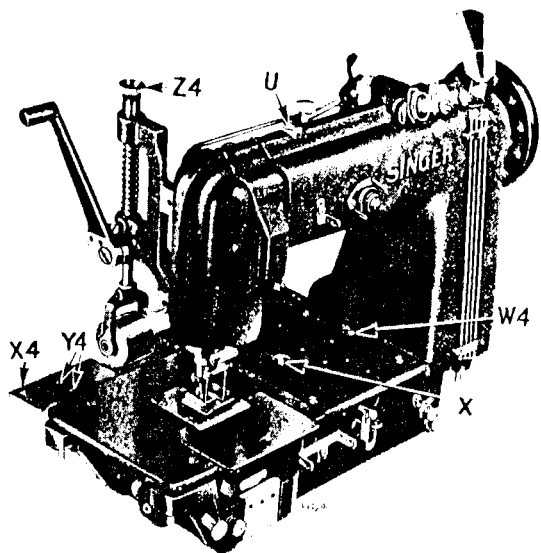

Fig. 33. Adjustments on Puller Feed Machine

Press in the knurled plunger **U**, Fig. 33 at the top of the machine and at the same time turn the machine pulley over toward you until the plunger enters a notch in the adjustable eccentric on the arm shaft, then turn the plunger to the right or left to lock it in position. Now, simultaneously press the buttons **X** and **W4**, Fig. 33 in the bed of the machine and at the same time turn the machine pulley over toward you to increase the length of

(over)

stitch or over from you to shorten the stitch, until the desired letter on the stitch indicator plate is opposite the arrow. Then release the buttons **X** and **W4** and **TURN** the knurled plunger **U** to the right or left until it springs outwardly and releases the eccentric. The machine is then ready for operation.

TO REGULATE THE PRESSURE OF THE UPPER FEED ROLL ON THE MATERIAL

The pressure of the upper feed roll on the material should be only sufficient to enable the feed rolls to pull the material from the compound feed of the machine, keeping it taut without slipping. To increase the pressure of the upper feed roll on the material, turn the thumb screw **Z4**, Fig. 33 over to the right or downwardly. To decrease the pressure on the upper feed roll, turn the thumb screw **Z4** over to the left or upwardly.

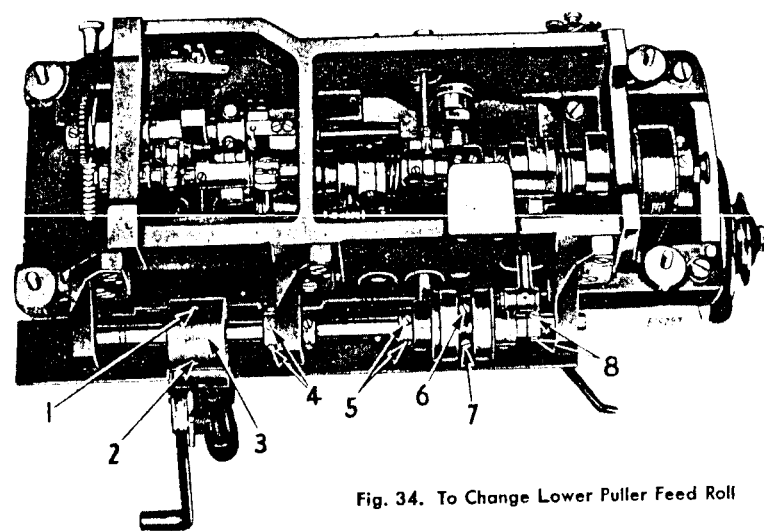

Fig. 34. To Change Lower Puller Feed Roll

TO CHANGE LOWER PULLER FEED ROLL

Remove the two screws **Y4**, Fig. 33 and take off the cover plate **X4**. Next loosen the screws **1**, **2**, **4**, **5**, **6**, **7** and **8**, Fig. 34 and slide the puller feed shaft to the right far enough to allow removal of the feed roll **3**. After the new feed roll has been placed on the shaft and the shaft and collars returned to their original positions, securely tighten all of the screws which were loosened, noting that screw **1** is tightened on a spline in the shaft and that screw **6** is tightened on a flat on the shaft.

THE SINGER MANUFACTURING COMPANY

Copyright, U. S. A., 1949, by The Singer Manufacturing Co.
All Rights Reserved for all Countries