



BEST QUALITY

Union Special[®]
LEWIS • COLUMBIA

INDUSTRIAL
SEWING
MACHINES

PROPERTY OF
DEVELOPMENT/CATALOG DEPT.
Please return to the Catalog Dept.
Date received to file: OCT 06 1992

INSTRUCTIONS
FOR
INSTALLING AND OPERATING
SEWING HEADS IN CLASS 14500
INCLUDING
LIST OF PARTS

CLASS
14500

CATALOG
No. 43
Third
Edition

Union Special MACHINE COMPANY
CHICAGO

14500

Catalog No. 43

INSTRUCTIONS
FOR
INSTALLING AND OPERATING
SEWING HEADS
IN
CLASS 14500

The parts listed in this catalog are
furnished at list prices for repairs only.

Third Edition

Copyright 1939
by
Union Special Machine Co.
Rights Reserved in All Countries

Union Special
MACHINE COMPANY
INDUSTRIAL SEWING MACHINES
CHICAGO

Printed in U.S.A.

November, 1965

FOREWORD

The one dominating idea back of "Union Special" is to build the best industrial sewing machines in the world. The name is a synonym for "Superlative Excellence".

It is our constant aim to furnish carefully prepared information that will enable the customer to secure all possible economies and advantages accruing from the use of Union Specials.

Dimensioned drawings of any of our equipment will be gladly furnished to mill engineers for their convenience in allocating floor space. Our engineers will welcome an opportunity to assist in solving your sewing problems.

In the pages which follow, detailed instructions are given for installing and operating the sewing heads in Class 14500, including a list of parts.

The following catalogs and prints applying to our Filled Bag Closing Machines will be furnished on request:

Catalog No. 29. List of Parts and information relating to the sewing head transmitter on the Fixed Base Machine Style 20100 H, and the Heavy Duty Machines in Class 20500.

Catalog No. 43 D. Instructions for assembling Table Type Machine Style 21800 C and sewing heads in Class 14500.

Catalog No. 43 E. Instructions for assembling Junior Machine Style 20100 D and sewing heads in Class 14500.

Catalog No. 43 F. Instructions for assembling Victor Machines in Class 20200 and sewing heads in Class 14500.

Catalog No. 43 G. Assembly drawing of Junior Machine Style 20100 D, with list of parts (drawing No. 3218 Q).

Catalog No. 43 H. Sub-assembly drawing of Heavy Duty Machines in Class 20500, with list of parts (drawing No. 5090 Q).

Catalog No. 43 J. Assembly drawing of Fixed Base Machine Style 20100 H, with list of parts (drawing No. 3238 Q).

Catalog No. 43 K. Assembly drawing of Table Type Machine Style 21800 C.

Catalog No. 45. List and description of needles.

Form 357. Engineering Department Adjusting Instructions for sewing heads in Class 14500.

Photo prints of parts for Victor Machines in Class 20200.

Union Special Machine Company

Engineering Department

IDENTIFICATION OF SEWING HEADS

A style number is stamped in the name plate attached to each sewing head. Style numbers are classified as standard and special. Those which are standard have one or more letters suffixed but never contain the letter "Z". Example: 14500 H. Style numbers containing the letter "Z" are special. When only minor changes are made in a standard machine a "Z" is merely suffixed to the respective standard style number. Example: 14500 HZ.

STANDARD STYLES OF SEWING HEADS IN CLASS 14500

- 14500 D Sewing Head, for closing bags made from light weight fabric; short length needle Type 124, double locked stitch Type 401, stitch range three to eight to inch, standard lengths four and eight to inch.
- 14500 F Sewing Head, for closing bags made from medium weight fabric; short length needle Type 124, double locked stitch Type 401, stitch range three to eight to inch, standard length four to inch.
- 14500 H Sewing Head, for closing bags made from heavy weight fabric; long length needle Type 144, double locked stitch Type 401, stitch range three to eight to inch, standard length four to inch.
- 14500 R Sewing Head, for closing bags made from heavy weight fabric; long length needle Type 144, double locked stitch Type 401, stitch range three to eight to inch, standard length four to inch, includes a friction drive pulley, suspended support, cable and associated parts, 1/4 H.P., friction drive electric motor.
- 14500 Z A special style, similar to the standard styles in Class 14500, but differing in one or more of its component parts.

APPLICATION OF CATALOG

This catalog applies only to the standard styles of sewing heads as listed. It can also be applied with discretion to the special sewing heads in Class 14500.

INSTALLING

READY TO OPERATE

Before shipment, each sewing head is thoroughly run in, accurately adjusted and carefully inspected. This is evidenced by the test sample left in the machine. Each complete apparatus, with the sewing head operating on fabric, is likewise given a thorough test. Packed by skilled hands, they arrive at their destination ready for service.

OPERATING (Cont'd)

OILING (Cont'd)

The sewing head transmitter on the Fixed Base Machine Style 20100 H and the Heavy Duty styles in Class 20500 is lubricated with solid oil through a hollow shaft from a compression cup, which, once a week should be screwed up until the resistance of the grease is noticeable. If, through lack of attention, the pulleys run hot, the compression cup should be screwed up immediately. Refilling will not be required oftener than once a month. No. 3 Arctic Cup Grease, or its equivalent in consistency will fill the requirements.

CLEANING

Accumulated lint and dust quickly absorb the oil, which makes it necessary to keep the sewing head as clean as possible.

Due to the corrosive action in salt blocks, it is necessary to clean the sewing head each day with compressed air or a steam jet, and subsequently spray the working parts with oil.

In fertilizer plants, the corrosive action is avoided by submerging the sewing head each night in a vessel containing equal parts of kerosene and machine oil.

SETTING THE NEEDLE

It has two grooves; a short groove terminating in a spot milled out adjacent to the eye, and a long groove extending from the shank to the eye. Insert the needle as far up into the needle bar as it will go with the long groove to the right, and so that the eye will be in line with the direction of the stitches. Then tighten the needle clamp nut with the wrench No. 116, furnished for the purpose.

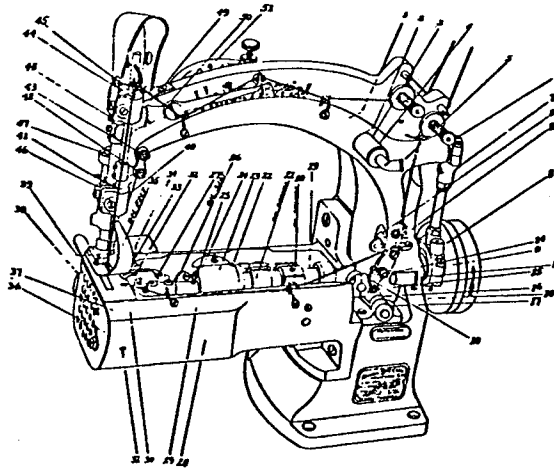

THREADING AND OILING DIAGRAM

OPERATING (Cont'd)

THREADING

Carry the thread upwardly from the cones, through the thread stand eyelets, and then proceed as shown in the diagram. The two threads should not cross each other. Under no circumstances should the thread be turned completely around the tension posts in threading between the tension discs.

SEWING TWINE

The machines require a sewing twine, as twine for wrapping purposes is too uneven.

We set up below the recommended twine sizes for various bag sizes.

Capacity of Bag	Needle Thread Size	Looper Thread Size
25 pounds	12/3	12/3
50 pounds	12/4 or 10/3	12/3
100 pounds	12/4 or 10/3	12/3
200 pounds	12/5 or 10/4	12/4 or 10/3
250 pounds	12/6, 10/5, or 8/4	12/5 or 10/4

REGULATING LENGTH OF STITCH

This is accomplished at the lower end of the main shaft. There three screws in a row will be found with a lock nut below them. The length of stitch is altered by loosening the nut and turning the stitch regulating screw which is the largest of the three. Turning it clockwise lengthens the stitch. To loosen nut, use wrench No. 115 and turn it in the direction the machine runs. Apply the wrench with the left hand and hold the machine pulley with the right hand.

With the Junior Machine Style 20100 D, which is equipped with a floating bag carrier, the stitch length is regulated entirely as described in the previous paragraph.

With the styles in Classes 20100, 20500 and 21800, which are equipped with conveyors, the stitch length on the sewing head must be synchronized with the linear speed of the conveyor.

With the Victor styles in Class 20200, the stitch length must be synchronized with the linear speed of the sewing head.

As all linear speeds are fixed before shipment, variations in the stitch length outside of the standard lengths specified in the definition of each style are secured by substituting a different size pulley rim on the sewing head that will change its R.P.M. Decreasing its R.P.M. will permit its making a longer stitch.

CAUTION

Always tighten the lock nut on the sewing head after any change has been made. Note the effect of turning the stitch regulating screw. If it is turned clockwise too far, the feed dog will strike the ends of the slots in the throat plate. If it is turned counter clockwise too far the sewing head will feed the bag to the right.

The location of the needle rear guard must be readjusted each time the length of stitch is altered.

OPERATING (Cont'd)

SUGGESTIONS

When a machine fails to work satisfactorily, though apparently in good repair, delay can be avoided by checking the following:

- (1) Note carefully whether the machine is threaded in every respect as directed, especially at the tensions, and remove any lint which may have accumulated.
- (2) See that the tension on the needle thread is as tight as is consistent with its strength, and yet avoids puckering the fabric.
- (3) See that the tension on the looper thread is barely sufficient to steady it.
- (4) Try a new needle.
- (5) Clean and oil the machine thoroughly.
- (6) The throat plate needle hole may have become roughened, which will cause breaking of the threads. This can be remedied by smoothing out the hole with a narrow strip of emery cloth.
- (7) If the foregoing measures fail to relieve the difficulty, it may be assumed that the sewing head needs a general re-adjustment, and the spare head should be substituted.

NEEDLES

TYPE NUMBERS AND SIZES

Each needle has a type number and a size number. The former denotes the kind of point, shank, length, groove, finish and other details. The latter denotes the largest diameter of the blade, measured in thousandths of an inch midway between the shank and eye, and is stamped in the needle shank. Collectively the type number and size number is the complete symbol.

The type numbers of the needles most commonly used in the styles of machines covered by this catalog are listed below. Set opposite each type number is the description of the needle.

Type No.	Description
124	Round shank, round point, short length, double groove, spotted, nickel plated.
143	Round shank, round point, No. 2 bag, long length, long point, double groove, spotted, nickel plated.
144	Round shank, round point, No. 2 bag, long length, short point, double groove, spotted, nickel plated.

APPLICATION OF TYPE NUMBERS

The styles of machines covered by this catalog are listed herein. Set opposite each style number is the type number of the needle generally used.

NEEDLES (Cont'd)

APPLICATION OF TYPE NUMBERS (Cont'd)

Machine Style No.	Type Nos. of Needles used
14500 D	124
14500 F	124
14500 H	144
14500 R	144

ORDERING

To have orders promptly and accurately filled, the empty package, a sample needle, or the type and size numbers should be given. See marks on packages. An intelligent order would read as follows: "100 Needles Type 144 Size .080".

ORDERING REPAIR PARTS

PLATES

Grouped together according to scale will be found illustrations of parts similar in appearance, and to some extent, component parts that go together in the same subdivisions of the mechanism.

When a given design of part is made in two or more sizes, only one illustration is usually shown. In ordering these pieces, it is necessary that the size be specified.

LIST OF PARTS

Turning from the plates to the list of parts, the description of each part and its principal uses will be found. Always check the symbol against its description before ordering. It is not necessary to furnish the plate number.

When a part is used or can be used in all sewing heads covered by this catalog, no specific use is mentioned in the description.

For convenience in ordering, minor parts such as screws, nuts, and similar articles are repeated after each major part.

(-) A dash in the "plate number" column of the list of parts denotes the absence of an illustration.

(‡) A double dagger in the "symbol to order by" column denotes that the component parts cannot be furnished separately.

IDENTIFYING PARTS

Where the construction permits, each part is stamped with its part number. Some of the smaller parts are stamped with an identification letter to distinguish them from parts similar in appearance.

All part numbers represent the same part, regardless of the catalog in which they appear.

ORDERING REPAIR PARTS (Cont'd)

SUPPLIES

All supplies, including belting, belt hooks, belt fasteners, transmitter lubricant, powdered oil stone, screw drivers, taps and reamers will be promptly furnished.

USE GENUINE NEEDLES AND REPAIR PARTS

Success in the operation of these machines can be secured only by the use of genuine Union Special Needles and Repair Parts as furnished by the Union Special Machine Company or its subsidiaries. Obviously, it is to our interest to maintain the reputation of Union Specials by furnishing the very best goods obtainable. They are designed according to the most approved scientific principles, and are made with the utmost precision. The maximum efficiency and durability are assured.

Genuine needles are packaged with labels marked *Union Special*. Genuine repair parts are stamped with the Union Special trade mark. Each trade mark is your guarantee of the highest quality in materials and workmanship.

TERMS

Prices are net cash and subject to change without notice. All shipments are forwarded f. o. b. shipping point. Parcel Post shipments are insured unless otherwise directed. A charge is made to cover postage and insurance.

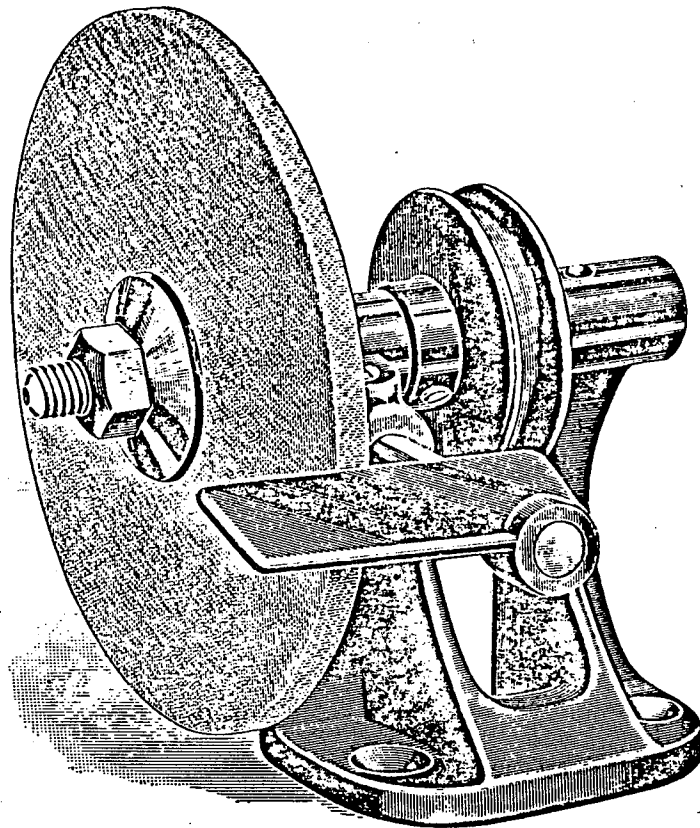

21394
Utility Grinder

Plate 1 - Full Size

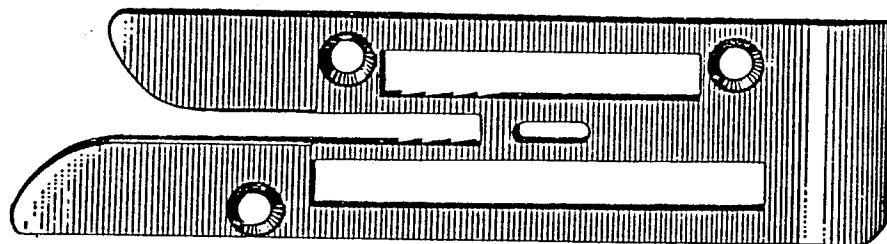
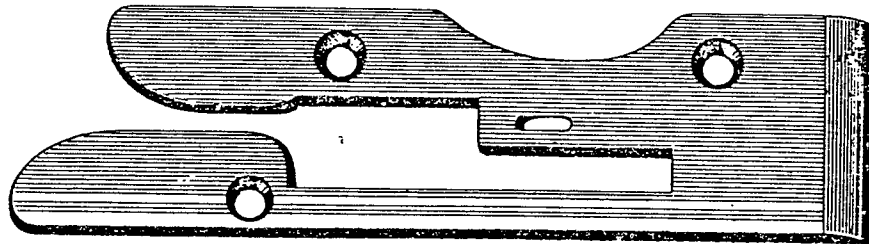
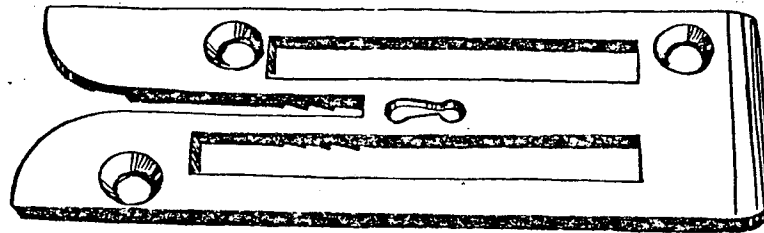
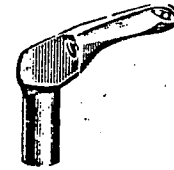
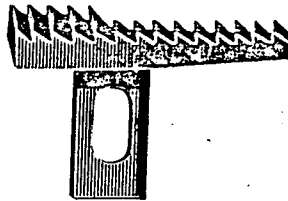
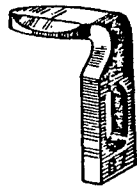
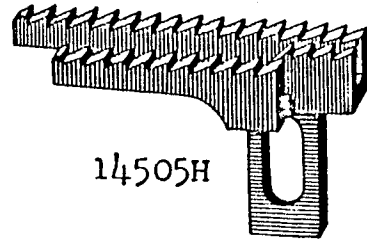
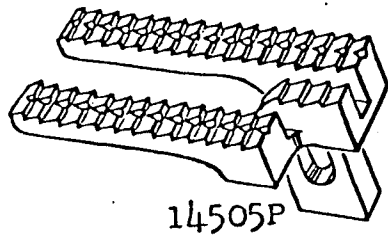
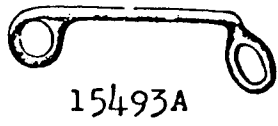

Plate 2 - Full Size



15493A



52 A



137



158



12534



337

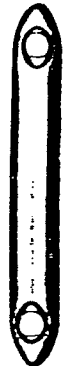

111

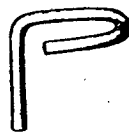

39



14530 B



14575



14536

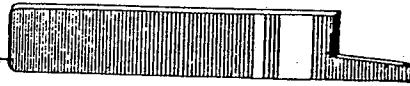

14577

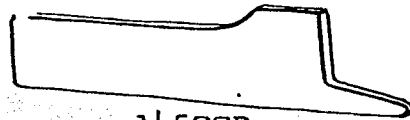

14577P

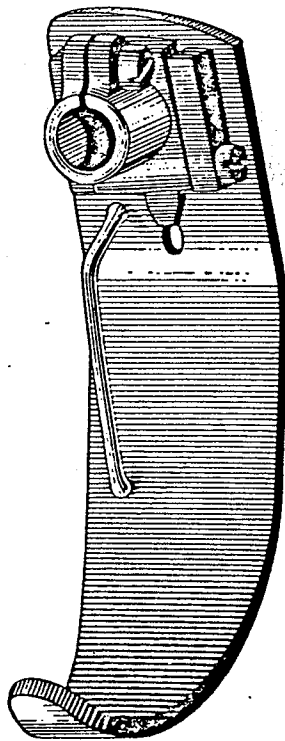

14527F

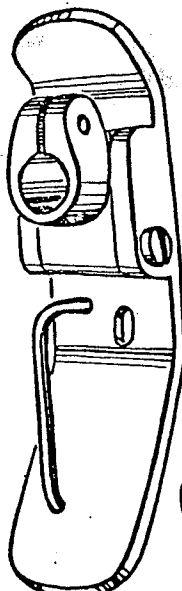

14520D

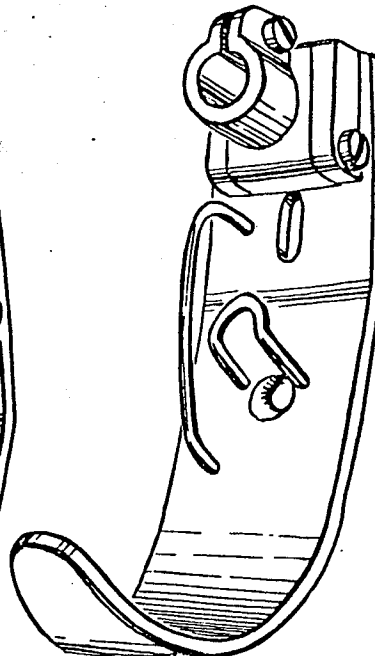

14520P

Plate 3 - Full Size

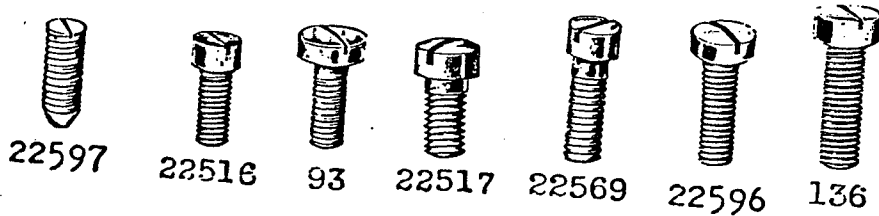
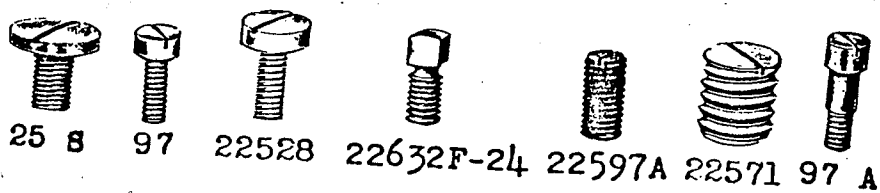
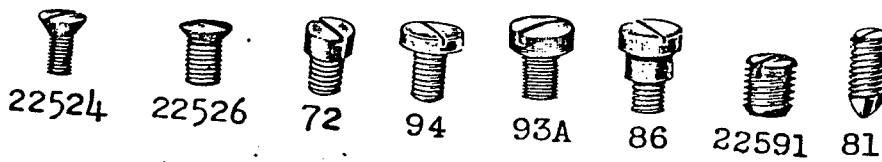
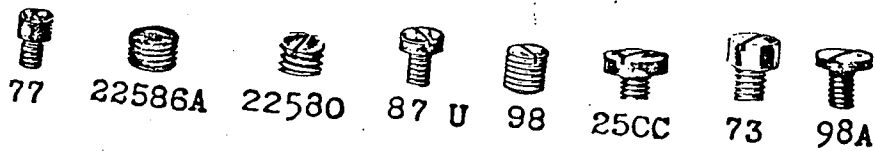
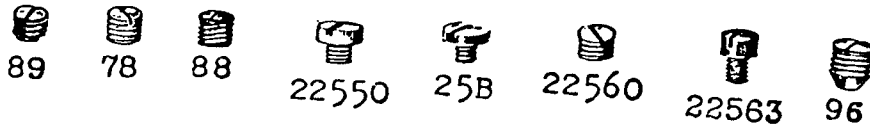

Plate 4 - Full Size



22540



15443



22572A



525



22793



22794



22592

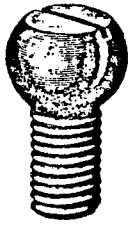

156



22587

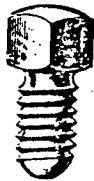

22509



141



10349



14076

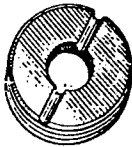

80464



82



17B

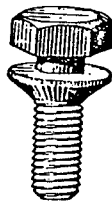

22823



318



22823A

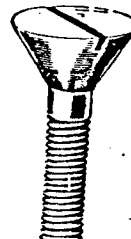

33

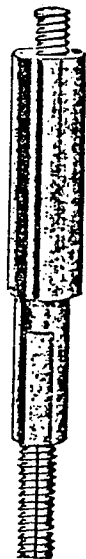

333



11261A

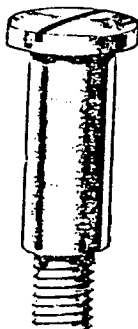

420

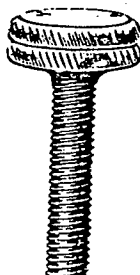

64 A



1279



G10



19155

Plate 5 - Full Size

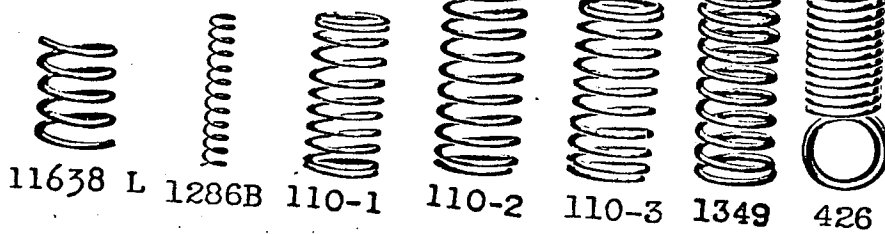
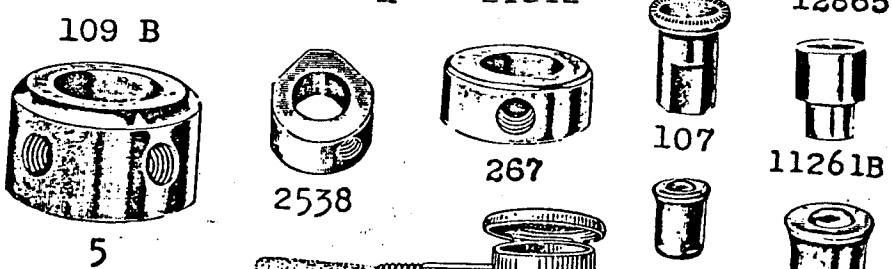
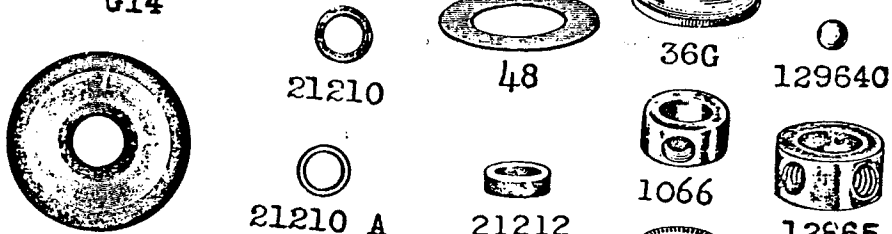
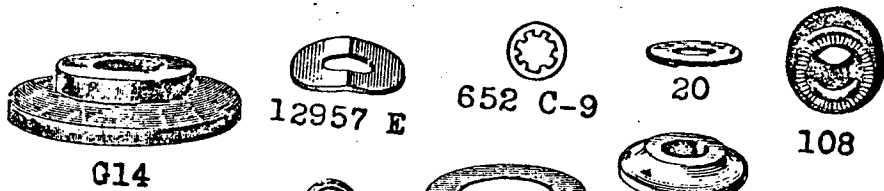
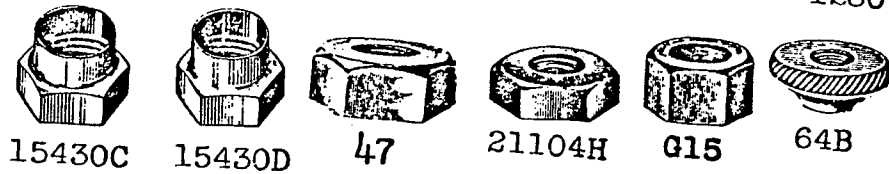
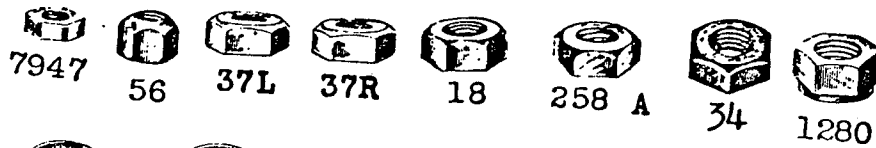
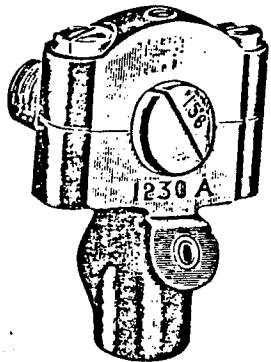
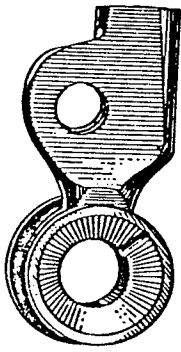

Plate 6 - Full Size



29066B



14513A

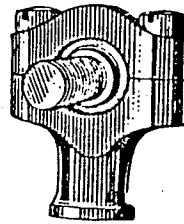

14564D



14552



304

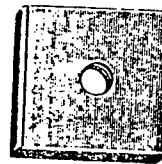

14672

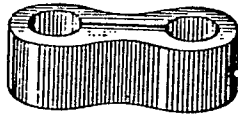

14542A

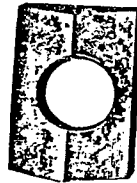

154



14530 A

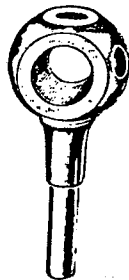

61C

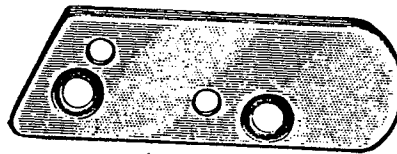

14598 B

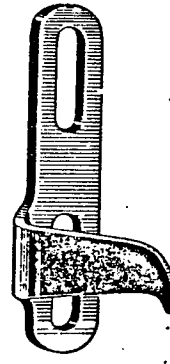

14565

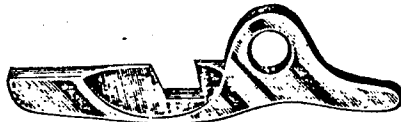

15498 N

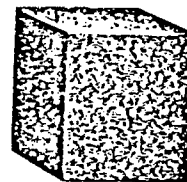

14580

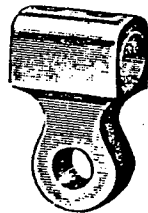

162

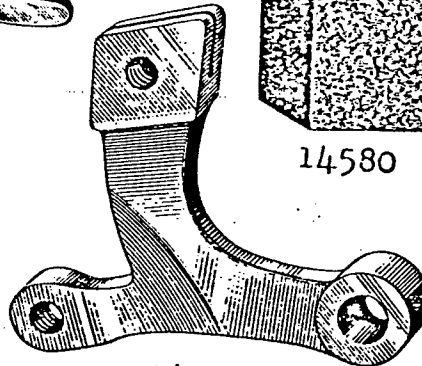

14578

Plate 7 - Full Size



21225
SPECIFY
MEASUREMENT

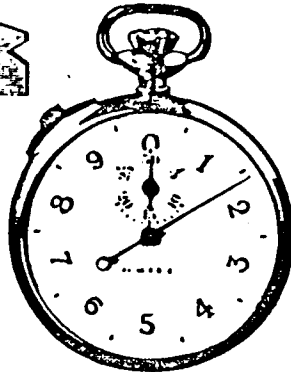

WA15



202A



V109



21351

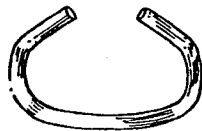

21351 A

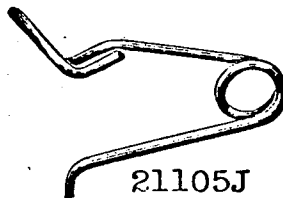

21105J

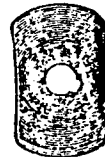

15498H

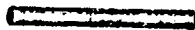

426A



1361A



21361



1286



1286 A



21363



13873



21362



16



299



1230D

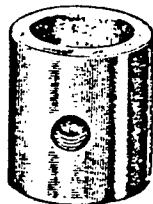

11614

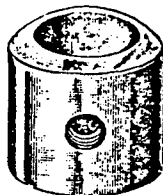

1806 A



21113 B



30090 C



14544

Plate 8 - One-half Size

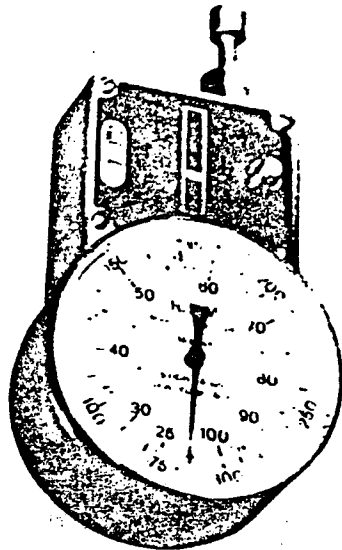

TA 55



15430L



118 B

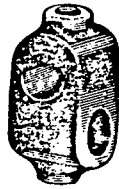

21104 C

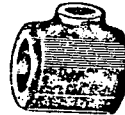

21104 E



21207

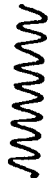

524

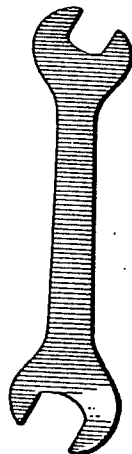

21388 R

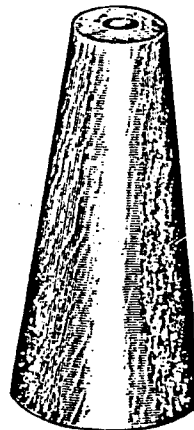

21145



21733 A



116

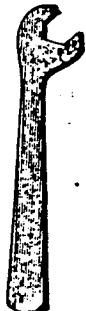

115

Plate 9 - One-half Size



1275A



1275E



1275F



1275H



1275J



11654



1230A



15442 B

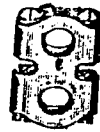

15442 C



54

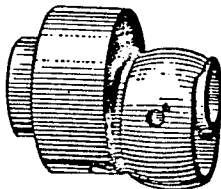

14585A

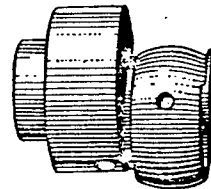

14585B



54 A

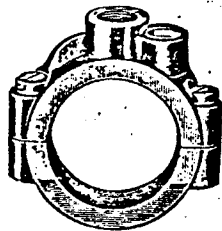

15430M

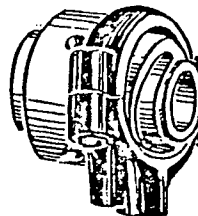

29089F

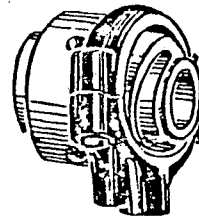

29089G

Plate 10 - One-half Size

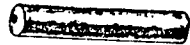

9274



14543



14550



172



335

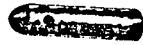

583



15498G



14546



14570



1230C



62C



69T



21113 A



60A



14531



50D

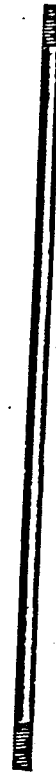

14653

Plate 11 - One-half Size

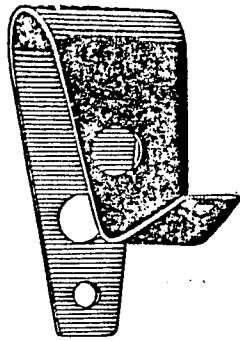

14582J



15498L

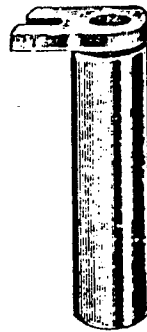

15498J



G12

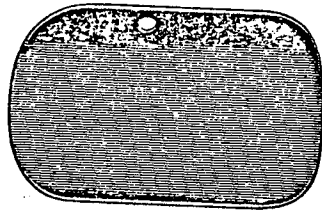

15498P

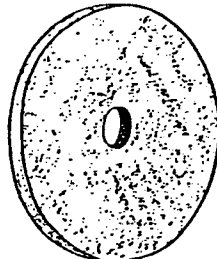

G18

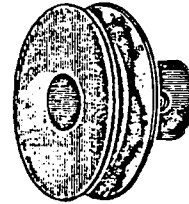

G11

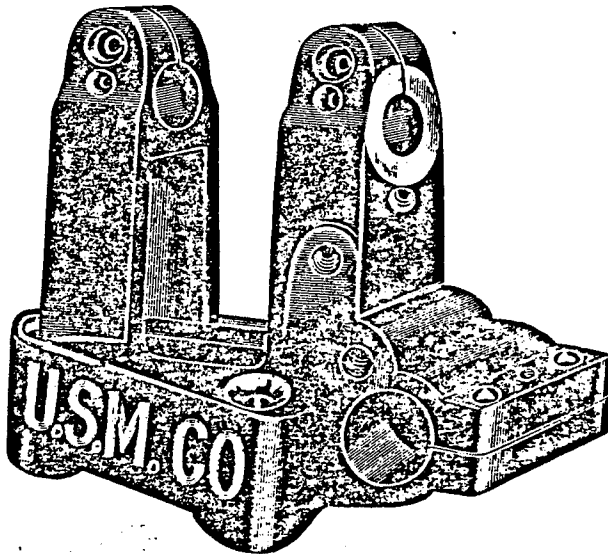

15498 E



15498K

Plate 12 - One-half Size

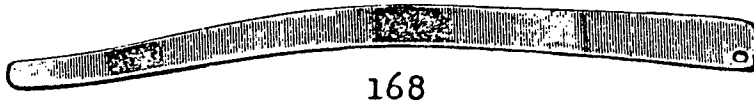

168

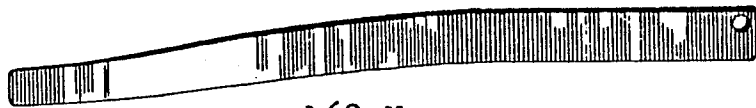

168 X

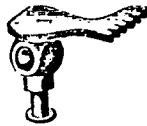

142C



291

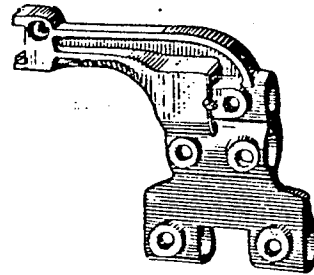

14541B

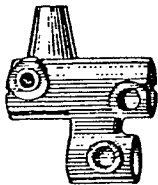

14547A

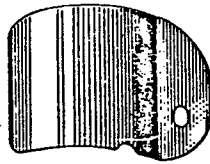

14566



14556

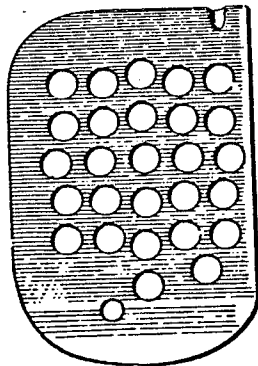

14539A



14555

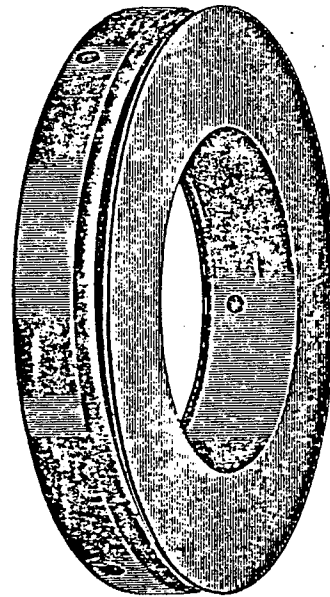

21382B

Plate 13 - One-third Size



14548



14674

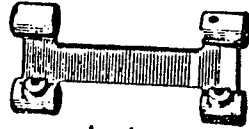

14545



14549



14671

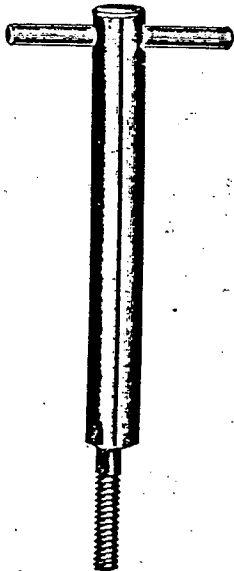

11670 A



316



14522

Plate 14 - One-fourth Size

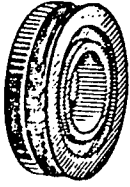

21382C-26

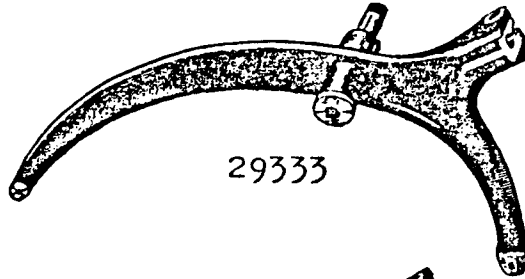

29333

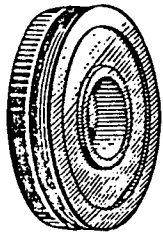

21382C-34

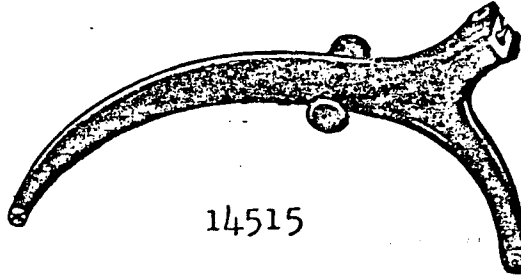

14515

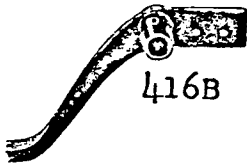

416B

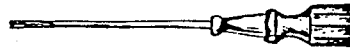

21201

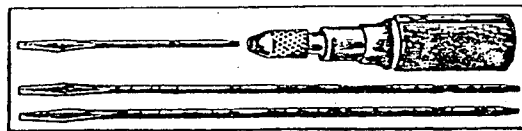

21208

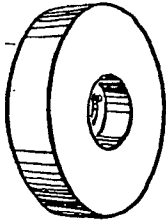

21382E

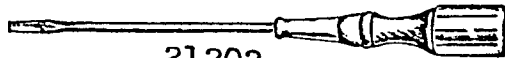

21202

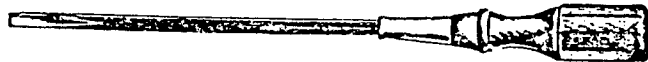

21205A

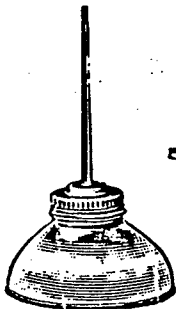

413

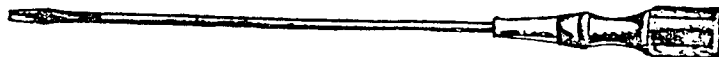

21204

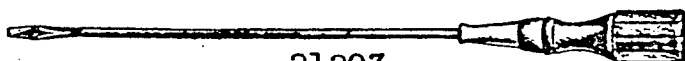

21203

Plate 15 - One-fourth Size

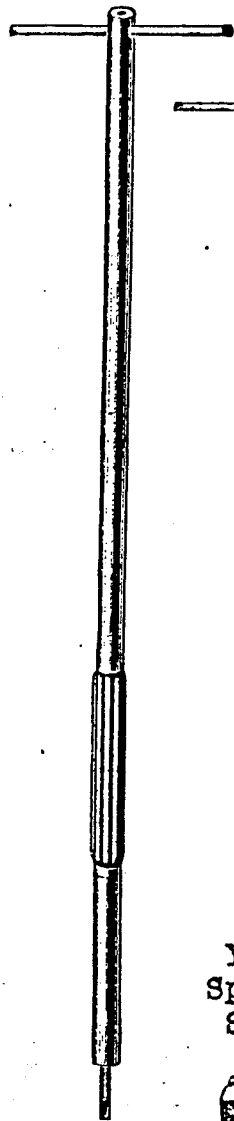

Y 506
Specify
Size

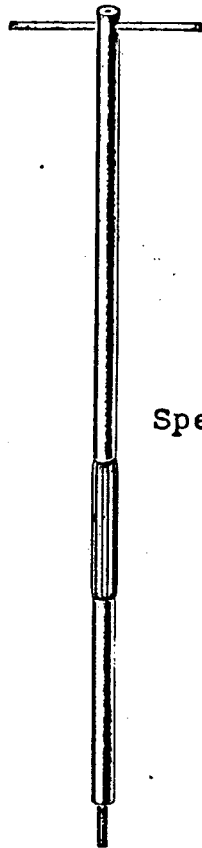

Y505
Specify
Size

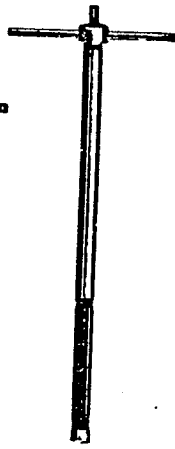

Y503
Specify Size



Y501
Specify
Size

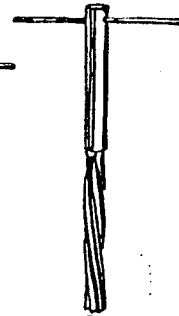

Y801



Y802



Y800

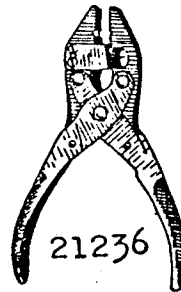

21236

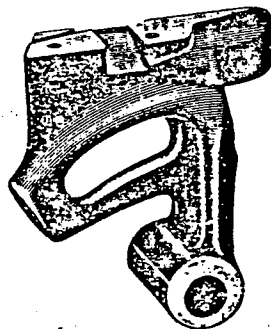

14598 A



29163B



21104 B
Specify
Length

Plate 16 - One-eighth Size

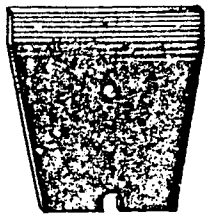

20162D

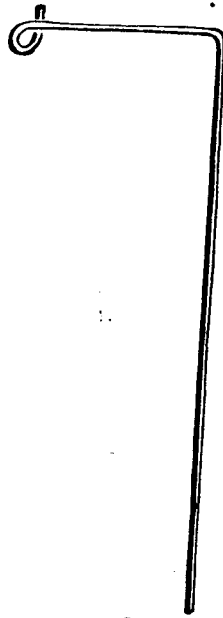

21113C

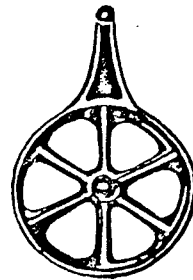

21130S



21104D



21104T

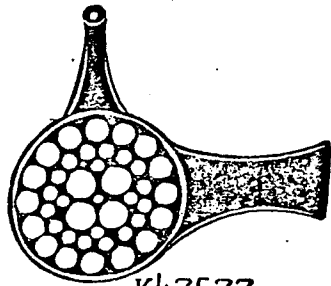

K47577



21104G



21104F



14540



14581

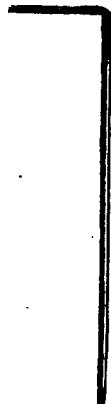

21104K

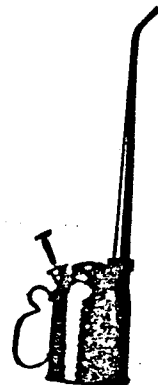

OI-19

Plate 17 - Three-fourths Size

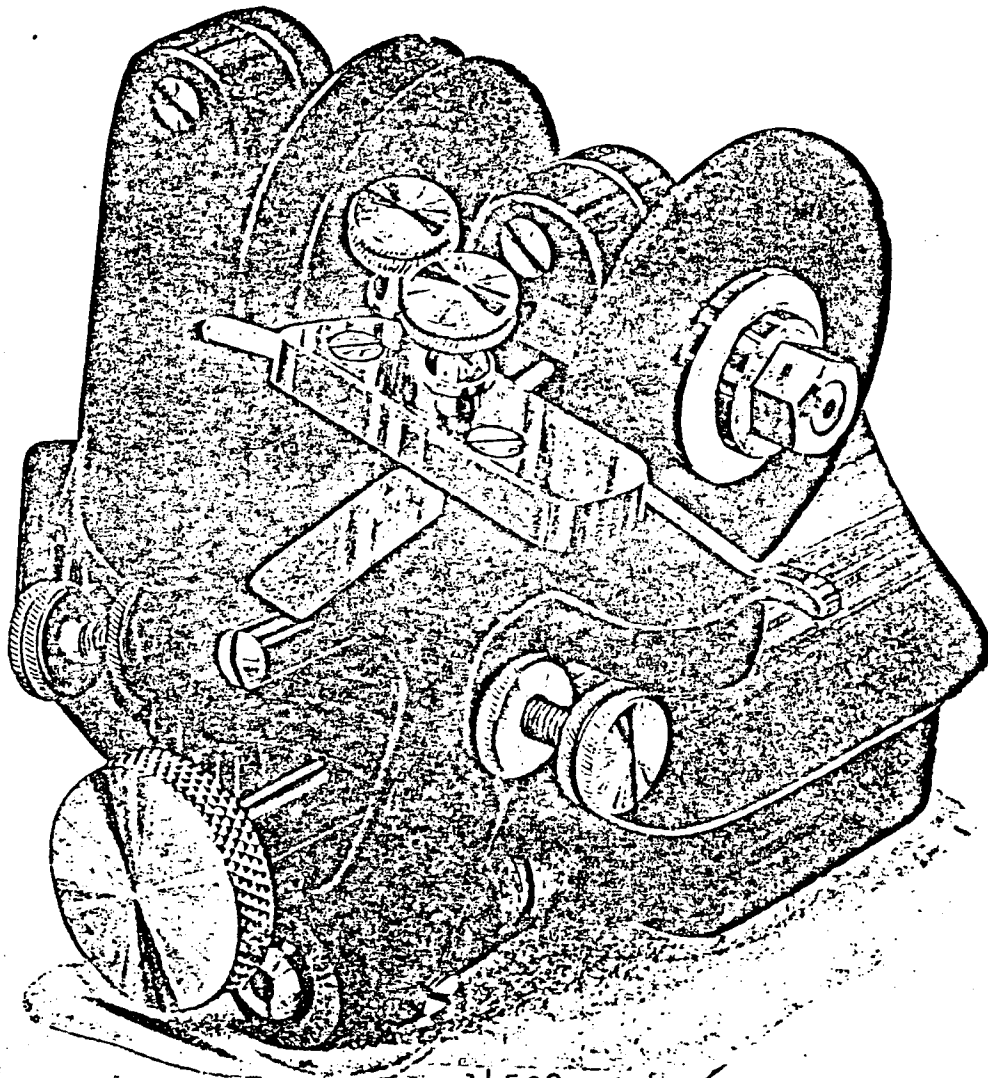

14598

KNIFE GRINDER

LIST OF PARTS

Symbol to Order By	The figures in the last column refer only to the plates illustrating the parts and are not to be used in ordering. Refer to pink insert for prices.	Plate No.
5	Main Shaft Collar (screw No. 95)- - - - -	5
G10	Thumb Screw, for holding knives in grinder No. 14598 - - - - -	4
G11	Pulley, for knife grinder (screw No. 98)- -	11
G12	Pulley Spindle, for knife grinder (screw No. 136)- - - - -	11
G14	Pulley Spindle Washer, for knife grinder- -	5
G15	Pulley Spindle Nut, for knife grinder - - -	5
WA15	Stop Watch- - - - -	7
16	Feed Crank Link Ferrule - - - - -	7
G16	Emery Wheel, for knife grinder- - - - -	11
17 B	Feed Crank Stud - - - - -	4
18	" " " Nut; also for No. 11654 - - -	5
OI-19	Pressure Pump Oil Can, 1 1/2 pints capacity	16
20	Feed Crank Stud Washer, also for No. 14580	5
25 B	Screw, for cylinder cover spring- - - - -	3
25 S	" for knife housing, also for No. 14582 J- - - - -	3
25 CC	Clamp Screw, for driven knife - - - - -	3
33	Looper Rocker Stud- - - - -	4
34	" " " Nut- - - - -	5
36 G	Upper Looper Connecting Rod Ball Joint Washer- - - - -	5
37 L	Looper Connecting Rod Nut, lower, left thread - - - - -	5
37 R	" " " " upper, right thread - - - - -	5
39	Frame Looper Thread Guide - - - - -	2
47	Needle Lever Stud Nut - - - - -	5
48	" " Washer- - - - -	5
50 D	" Bar (screw No. 88 A) - - - - -	10
52 A	" Lever Thread Eyelet, lower (screw No. 98 A)- - - - -	2
54	" Lever Link, lower- - - - -	9
54 A	" " upper- - - - -	9
TA54	Hand Tally- - - - -	-
TA55	" Tachometer, 4 speed type, 90 to 12000 R.P.M. - - - - -	8
56	Needle Clamp Nut- - - - -	5
60 A	Presser Bar, standard diameter .319 inch, for Style 14500 D- - - - -	10
60 A-322	" " standard diameter plus .003 inch - - - - -	-
60 A-325	" " standard diameter plus .006 inch - - - - -	-
60 A-328	" " standard diameter plus .009 inch - - - - -	-
60 A-331	" " standard diameter plus .012 inch - - - - -	-
60 A-334	" " standard diameter plus .015 inch - - - - -	-

LIST OF PARTS

Symbol to Order By	The figures in the last column refer only to the plates illustrating the parts and are not to be used in ordering. Refer to pink insert for prices.	Plate No.
61 C	Presser Bar Connection (screw, right, No. 88, screw, left, No. 77)- - - - -	6
62 C	Presser Guide Bar, standard diameter .319 inch	10
62 C-322	" " " standard diameter plus .003 inch- - - - -	-
62 C-325	" " " standard diameter plus .006 inch- - - - -	-
62 C-328	" " " standard diameter plus .009 inch- - - - -	-
62 C-331	" " " standard diameter plus .012 inch- - - - -	-
62 C-334	" " " standard diameter plus .015 inch- - - - -	-
64 A	" Spring Regulating Screw, also for No. 14598 A - - - - -	4
64 B	" Spring Regulating Screw Lock Nut, also for No. 14598 A - - - - -	5
69 T	Filler Cord Cone Support Pin, for use on bag closing frames in Class 21800 - - - - -	10
72	Set Screw, for looper eccentric fork- - - - -	3
73	" " for looper - - - - -	3
77	" " fillister head, for needle lever link pin, also for No. 61 C - - - - -	3
78	" " headless, for needle lever link pin - - - - -	3
81	Spot Screw, for feed lift arm - - - - -	3
82	Screw, for regulating length of stitch- - - - -	4
86	" for knife setting gauge on knife grinder - - - - -	3
87 U	" for needle thread take-up wire - - - - -	3
88	Set Screw, for feed bar, also for Nos. 61 C, 1066, 2538, 12865, 14555, 14578 - - - - -	3
88 A	Set Screw, for needle bar; also for Nos. 142 C, 14552- - - - -	3
89	Set Screw, for feed rocker; also for Nos. 14543, 14550- - - - -	3
90	Screw, for frame looper thread take-up; also for No. 14566 - - - - -	3
91	Clamp Screw, for presser feet - - - - -	3
93	Screw, for knife lubricating felt, also for No. 15493 A - - - - -	3
93 A	Screw, for grinder swinging frame pivot pin friction washer - - - - -	3
94	Screw, for needle thread take-up wire post; also for No. 14575- - - - -	3
95	Set Screw, for main shaft collar; also for Nos. 111, 172, 335, 337- - - - -	3
96	Spot Screw, for looper avoid eccentric- - - - -	3
96 A	" " for feed lift cam; also for No. 14674 - - - - -	3
97	Screw, for supporting feed dogs - - - - -	3
97 A	" for looper connecting rod ball joints; also for No. 15442 C - - - - -	3

LIST OF PARTS

Symbol to Order By	The figures in the last column refer only to the plates illustrating the parts and are not to be used in ordering. Refer to pink insert for prices.	Plate No.
98	Screw, for looper rock shaft collar; also for Nos. G11, 267, 14543- - - - -	3
98 A	" for needle lever thread eyelets; also for No. 137 - - - - -	3
107	Tension Spring Ferrule - - - - -	5
108	" Regulating Nut - - - - -	5
109 B	" Disc - - - - -	5
V109	Tap, marked "J-2", for screw No. 22526 - - - - -	7
110-1	Tension Spring, .026 inch diameter wire, for filler cord on Style 14500 P - - - - -	5
110-2	Tension Spring, .028 inch diameter wire, for looper thread- - - - -	5
110-3	Tension Spring, .040 inch diameter wire, for needle thread on Styles 14500 F, 14500 H, 14500 P, 14500 R - - - - -	5
111	Tension Thread Eyelet, with two holes, for Styles 14500 D, 14500 F, 14500 H, 14500 R (screw No. 95) - - - - -	2
115	Wrench, single end, 3/8 inch opening, for looper connecting rod nuts- - - - -	8
116	Wrench, single end, 9/32 inch opening, for needle clamp nut - - - - -	8
118 B	Thread Tweezers- - - - -	8
136	Clamp Screw, for pulley spindle on knife grinder; also for No. 15498 J- - - - -	3
137	Cylinder Thread Eyelet (screw No. 98 A)- - - - -	2
141	Needle Thread Controller Lever Screw - - - - -	4
142 C	" " " " Rack (screw No. 88 A) - - - - -	12
154	" Lever Buffer, wood fibre- - - - -	6
156	" Ball- - - - -	4
158	" Thread Eyelet (screw No. 98 A)- - - - -	2
162	" Bar Connection- - - - -	6
168	Presser Spring, for Styles 14500 D, 14500 F, 14500 H, 14500 R - - - - -	12
168 X	Presser Spring, for Style 14500 P- - - - -	12
172	Tension Thread Eyelet, with three holes, for Style 14500 P (screw No. 95) - - - - -	10
202 A	Needle Thread Take-up Wire Post (screw No. 94) - - - - -	7
258 A	Nut, for lower looper connecting rod ball joint - - - - -	5
267	Swinging Frame Pivot Pin Collar, for knife grinder (screw No. 98) - - - - -	5
291	Looper Rock Shaft Collar (screw No. 22580) - - - - -	12
299	" Differential Rocker Pin - - - - -	7
304	Feed Crank Stud Cap (screw No. 22563)- - - - -	6
316	Looper Avoid Shaft, standard diameter .407 inch - - - - -	13

LIST OF PARTS

Symbol to Order By	The figures in the last column refer only to the plates illustrating the parts and are not to be used in ordering. Refer to pink insert for prices.	Plate No.
316-408	Looper Avoid Shaft, standard diameter plus	
316-410	" " " .001 inch-	
316-413	" " " .003 inch-	
316-416	" " " .006 inch-	
318	" " " .009 inch-	
333	Screw, for cylinder-	
335	Tension Post, 2 5/8 inches long, for filler cord on Style 14500 P	4
337	Tension Thread Eyelet, with one hole, length overall 2 1/8 inches, for Style 14500 P (screw No. 95)	4
413	Tension Thread Eyelet, with one hole, length overall 1 7/16 inches (screw No. 95)	10
416 B	Oil Can-	2
420	Lifter Lever Casting	14
426	" " " Stud-	14
426 A	" " " Spring-	4
Y501-257	" " " Pin-	5
Y503-319	Expansion Reamer, for needle bar, size .257 inch for presser bar and presser guide bar, size .319 inch-	7
Y503-322	" " " size .322 inch	15
Y503-325	" " " size .325 inch	15
Y503-328	" " " size .328 inch	15
Y503-331	" " " size .331 inch	15
Y505-407	for feed drive shaft and looper avoid shaft; size .407 inch	15
Y505-410	" " " size .410 inch	15
Y505-413	" " " size .413 inch	15
Y505-416	" " " size .416 inch	15
Y505-419	" " " size .419 inch	15
Y506-530	for main shaft, size .530 inch	15
522	Cylinder Cover Spring (screw No. 25 B)	15
523	" " " Bolt-	5
524	" " " Spring	10
525	" " " Knob	8
652 C-9	Shake-Proof Lock Washer, for needle bar eyelets	4
666-1	Oil Cup, for needle lever stud	5
666-6	" " " for upper main shaft bearing-	5
Y800	Taper Reamer, for lever end of needle lever stud	5
Y801	" " " for frame end of needle lever stud	15
Y802	" " " for needle lever link pins	15
1066	Feed Lift Link Pin Collar (screw No. 88)	15
1230 A	Needle Lever Connecting Rod Front Bearing (screw No. 22587)	5
1230 B	Needle Lever Connecting Rod Front Bearing Valve Spring	9

See Page 9

LIST OF PARTS

Symbol to Order By	The figures in the last column refer only to the plates illustrating the parts and are not to be used in ordering. Refer to pink insert for prices.	Plate No.
1230 C	Needle Lever Connecting Rod Tube (nut, left thread, No. 15430 C, nut, right thread, No. 15430 D) - - - - -	10
1230 D	Needle Lever Connecting Rod Front Bearing Valve (screw No. 22586 A) - - - - -	7
1275 A	Needle Lever Stud, taper bearing, standard diameter - - - - -	9
1275 E	Needle Lever Stud, plus size on FRAME section, viz: .001, .002, .003, .006, .012, .018 inch; specify plus amount. Example: 1275 E-003 represents a stud plus .003 inch on FRAME section - - - - -	9
1275 F	Needle Lever Stud, plus size on LEVER section, viz: .001, .002, .003, .006 inch; specify plus amount. Example: 1275 F-003 represents a stud plus .003 inch on LEVER section - - - - -	9
1275 H	Needle Lever Stud, plus size equal on EACH section, viz: .001, .002, .003, .006 inch; specify plus amount. Example: 1275 H-003 represents a stud plus .003 inch on EACH section - - - - -	9
1275 J	Needle Lever Stud, plus size unequal on each section, viz: (.001, .002) (.001, .003) (.001, .006) (.002, .001) (.002, .003) (.002, .006) (.003, .001) (.003, .002) (.003, .006) (.006, .001) (.006, .002) (.006, .003) (.012, .001) (.012, .002) (.012, .003) (.012, .006) (.018, .001) (.018, .002) (.018, .003) (.018, .006). Specify plus amounts, arranged FRAME section first and LEVER section last. Example: 1275 J-003-006 represents a stud plus .003 inch on FRAME section and .006 inch on LEVER section; 1275 J-006-003 represents a stud plus .006 inch on FRAME section and .003 inch on LEVER section (screw No. 22586 B) - - - - -	9
	Needle Lever Stud Felt No. 15430 L Note: Before lapping the bearing of a needle lever and a needle lever stud remove the felt from the stud and replace it after the lapping compound has been washed out.	
1279	Needle Lever Ball Stud Clamp Bolt - - - - -	4
1280	" " " " " " Nut - - - - -	5
1286	" " Link Pin Assembly; one each Nos. 1286 A, 1286 B, 12964 C, 22560 - - -	7
1286 A	" " Link Pin (set screw, fillister head No. 77, set screw, headless No. 78)	7
1286 B	" " Link Pin Spring (screw No. 22560) - - -	5
1349	Tension Spring, for needle thread on Style 14500 D - - - - -	5
1361 A	Presser Spring Pin - - - - -	7
1805 A	Feed Dog, for Style 14500 D (screw No. 22596) - - -	1
1806 A	" Lift Cam (spot screw No. 96 A) - - - - -	7

LIST OF PARTS

Symbol to Order By	The figures in the last column refer only to the plates illustrating the parts and are not to be used in ordering. Refer to pink insert for prices.	Plate No.
2538	Needle Thread Controller Lever Rack Supporting Collar; also for No. 9274 (screw No.88)	5
7947	Feed Crank Link Nut - - - - -	5
9274	Knife Bar Shaft Support Pin - - - - -	10
10349	" " Double Ball Joint Stud, front - - - - -	4
11261 A	Tension Post, 1 7/8 inches long - - - - -	4
11261 B	" " Ferrule, 31/64 inch long - - - - -	5
11614	Looper Avoid Eccentric (spot screw No. 96) - - - - -	7
11638 L	Knife Bar Spring - - - - -	5
†11654	Looper Connecting Rod Ball Joint, upper (washer No. 36 G, bearing screw No. 97 A, nut No. 18) - - - - -	9
11670 A	"T" Screw, for sewing head - - - - -	13
12534 .	Needle Bar Thread Eyelet (screw No. 22768, lock washer No. 652 C-9) - - - - -	2
12865	Feed Bar Shaft Collar (screw No. 88) - - - - -	5
12873	Needle Bar Bushing (clamp screw No. 22569) - - - - -	7
12957 E	Cylinder End Guard Spring Washer - - - - -	5
12964 C	Needle Lever Link Pin Ball - - - - -	5
14076	Cylinder End Guard Pivot Stud - - - - -	4
14505 H	Feed Dog, for Styles 14500 F, 14500 H, 14500 R (screw No. 22596) - - - - -	1
14505 P	Feed Dog, for Style 14500 P (screw No. 22596)	1
14508	Looper (screw No. 73) - - - - -	1
14513 A	Looper Rocker - - - - -	6
14515	Needle Lever - - - - -	14
14520 D	Presser Foot, for Style 14500 D (clamp screw No. 91, hinge screw No. 22793) - - - - -	2
14520 P	Presser Foot, for Style 14500 P (clamp screw No. 91, hinge screw No. 22794) - - - - -	2
14522	Main Shaft, standard diameter .530 inch - - - - -	17
14522-533	" " standard diameter plus .003 inch - - - - -	—
14522-536	" " standard diameter plus .006 inch - - - - -	—
14524 D	Throat Plate, for Style 14500 D - - - - -	1
14524 H	" " for Styles 14500 F, 14500 H, 14500 R - - - - -	1
14524 P	" " for Style 14500 P - - - - -	1
	Throat Plate Screw No. 22524	
14525	Needle Guard, marked "BZ" (screw No. 22596)	1
14527 F	Presser Foot, for Styles 14500 F, 14500 H, 14500 R (clamp screw No. 91, hinge screw No. 22794) - - - - -	2
14529 B	Cylinder, for Styles 14500 D, 14500 F, 14500 H, 14500 R (screw No. 318) - - - - -	—
	Note: This part is furnished only when repairs are made at factory.	
†14530 A	Needle Thread Controller Lever Assembly (screw No. 141) - - - - -	6
14530 B	Needle Thread Controller Lever Eyelet - - - - -	2
14531	Presser Bar, standard diameter .519 inch, for Styles 14500 F, 14500 H, 14500 P, 14500 R	10

†See Page 9

LIST OF PARTS

Symbol to Order By	The figures in the last column refer only to the plates illustrating the parts and are not to be used in ordering. Refer to pink insert for prices.	Plate No.
14531-322	Presser Bar, standard diameter plus .003 inch-	—
14531-325	" " standard diameter plus .006 inch-	—
14531-328	" " standard diameter plus .009 inch-	—
14531-331	" " standard diameter plus .012 inch-	—
14531-334	" " standard diameter plus .015 inch-	—
14536	Needle Thread Take-up Wire (screw No. 87 U)-	2
14539 A	Cylinder End Guard (washer No. 12957 E, stud No. 14076) - - - - -	12
14540	Cylinder Cover - - - - -	16
14541 B	Feed Bar (set screw No. 88)- - - - -	12
14542 A	Feed Lift Link - - - - -	6
14543	Feed Lift Link Pin (screw, front, No. 89, rear, No. 98)- - - - -	10
14544	Feed Bar Shaft - - - - -	7
14545	" Rocker (screw No. 89) - - - - -	13
14546	" " Shaft, 4 13/16 inches long, standard diameter .319 inch- - - - -	10
14546-322	" " Shaft, standard diameter plus .003 inch- - - - -	—
14546-325	" " Shaft, standard diameter plus .006 inch- - - - -	—
14546-328	" " Shaft, standard diameter plus .009 inch- - - - -	—
14547 A	" Lift Arm and Knife Rocker Arm (screw No. 81) - - - - -	12
14548	" Drive Shaft, 6 1/8 inches long, standard diameter .407 inch- - - - -	13
14548-408	" Drive Shaft, standard diameter plus .001 inch- - - - -	—
14548-410	" Drive Shaft, standard diameter plus .003 inch- - - - -	—
14548-413	" Drive Shaft, standard diameter plus .006 inch- - - - -	—
14548-416	" Drive Shaft, standard diameter plus .009 inch- - - - -	—
14549	" Crank Link (clamp screw No. 22572 A, clamp screw lock nut No. 7947)- - - - -	13
14550	" Crank Link Pin (screw No. 89) - - - - -	10
14552	" Lift Cam Fork Shoe (screw No. 88 A) - - - - -	6
14555	" Looper Differential Rocker (screw No. 88)- - - - -	12
14556	" " Support (screw No. 22517)- - - - -	12
14564 D	Looper Connecting Rod Ball Joint, lower (nut No. 258 A, bearing screw No. 97 A) - - - - -	6
14565	Frame Looper Thread Take-up (screw No. 90) - - - - -	6
14566	Stitch Regulating Screw Guard (screw No. 90) - - - - -	12
14570	Main Shaft Bushing, upper- - - - -	10
14575	Knife, stationary (screw No. 94) - - - - -	2
14577	" driven, for Styles 14500 D, 14500 F, 14500 H, 14500 R (screw No. 25 CC)- - - - -	2

See Page 9

LIST OF PARTS

Symbol to Order By	The figures in the last column refer only to the plates illustrating the parts and are not to be used in ordering. Refer to pink insert for prices.	Plate No.
14577 P	Knife, driven, for Style 14500 P (screw No. 25 CC)	2
14578	Knife Bar (screw No. 88)	6
14580	" Lubricating Felt (screw No. 93, washer No. 20)	6
14581	" Housing (screw No. 25 S)	16
14582 J	Needle Bar Guard (screw No. 25 S)	11
14585 A	" Lever Eccentric, throw .588 inch, for Styles 14500 D, 14500 F (screw No. 22597)	9
14585 B	" Lever Eccentric, throw .634 inch, for Styles 14500 H, 14500 P, 14500 R (screw No. 22597)	9
14598	Knife Grinder, complete	17
14598 A	" Grinder Swinging Frame (set screw No. 22591, stop screw No. 64 A, stop screw check nut No. 64 B)	15
14598 B	Knife Grinder Swinging Frame Top Plate (screw No. 22516)	6
14653	Looper Connecting Rod (nut, left thread, No. 37 L, nut, right thread, No. 37 R)	10
14671	Looper Avoid Eccentric Fork (set screw No. 72, adjusting screw No. 22592)	13
14672	Looper Avoid Eccentric Fork Shoe (screw No. 22570)	6
14674	Feed Lift Cam Fork (set screw No. 22580, spot screw No. 96 A, clamp screw No. 22592)	13
15430 C	Needle Lever Connecting Rod Tube Nut, left thread	5
15430 D	Needle Lever Connecting Rod Tube Nut, right thread	5
15430 L	Needle Lever Connecting Rod Tube Felt; also for Nos. 1275 A, 1275 E, 1275 F, 1275 H, 1275 J	8
‡15430 M	Needle Lever Connecting Rod Rear Bearing (screw No. 22587)	9
15442 B	Knife Bar Double Ball Joint Assembly; one each Nos. 15442 C, 10349, 15443	9
‡15442 C	Knife Bar Double Ball Joint Shell (screw No. 97 A)	9
15443	" " " " Ball Stud, rear	4
15493 A	Filler Cord Guide, attaches to sewing head at lower needle bar lug (screw No. 93)	2
15498 E	Grinder Head, for knife grinder No. 14598	11
15498 G	" Swinging Frame Pivot Pin, for knife grinder No. 14598	10
15498 H	" Swinging Frame Pivot Pin Friction Washer (screw No. 93 A)	7
15498 J	" Swinging Frame Adjusting Sleeve (clamp screw No. 136)	11
15498 K	" Swinging Frame Adjusting Thumb Screw	11
15498 L	" " " Stop Pin	11
15498 N	Knife Setting Gauge, for knife grinder No. 14598 (screw No. 86)	6

LIST OF PARTS

Symbol to Order By	The figures in the last column refer only to the plates illustrating the parts and are not to be used in ordering. Refer to pink insert for prices.	Plate No.
15498 F	Dust Guard, for knife grinder No. 14598 (screw No. 22570) - - - - -	11
19155	Feed Lift Link Pin - - - - -	4
20162 D	Sewing Head Quick Change Adapter Plate (screw No. 22823) - - - - -	16
21104 B-2	Thread Stand Rod, 2 inches long (screw No. 22509) - - - - -	15
21104 B-5	" " " five inches long (screw No. 22509) - - - - -	15
21104 B-9	" " " nine inches long (screw No. 22509) - - - - -	15
21104 B-20	Filler Cord Support Rod, 20 inches long, for use on bag closing frames in Classes 20100, 20200, 20500 (screw No. 22509) - - - - -	15
21104 C	Thread Stand Rod Connection; also filler cord support rod (screw No. 22509) - - - - -	8
21104 D	" " " Seat - - - - -	16
21104 E	" " " Connection - - - - -	8
21104 F	" " " Pad - - - - -	16
21104 G	Thread Stand Seat Pin; also filler cord cone support pin, for use on filled bag closing frames in Classes 20100, 20200, 20500 - - - - -	16
21104 H	Thread Stand Seat Pin Nut, also filler cord cone support pin nut - - - - -	5
21104 K	Thread Stand Wire, sixteen inches long (screw No. 22632 F-24) - - - - -	16
21104 T	Thread Stand Rod, seven inches long, with shoulder - - - - -	16
21105 J	Thread Stand Wire Eyelet - - - - -	7
21113 A	" " " Extension, 6 inches long (screw No. 22632 F-24) - - - - -	10
21113 B	" " " Coupling (screw No. 88) - - - - -	7
21113 C	Filler Cord Guide Wire - - - - -	16
21130 S	Filler Cord Cone Support, for use on bag closing frames in Classes 20100, 20200, 20500 - - - - -	16
21145	Cone, wood, for thread stand - - - - -	8
21201	Screw Driver, 9/64 inch round blade, length overall 7 5/8 inches - - - - -	14
21202	" " " 7/32 inch round blade, length overall 11 1/4 inches - - - - -	14
21203	" " " 13/64 inch round blade, length overall 15 1/2 inches - - - - -	14
21204	" " " 9/32 inch round blade, length overall 15 inches - - - - -	14
21205 A	" " " 3/8 inch round blade, length overall 14 inches - - - - -	14
21207	" " " 7/64 inch round blade, length overall 2 1/2 inches - - - - -	8
21208	" " " Set, three detachable blades - - - - -	14
21210	Looper Collar, .040 inch thick - - - - -	5
21210 A	" " " .020 inch thick - - - - -	5

LIST OF PARTS

Symbol to Order By	The figures in the last column refer only to the plates illustrating the parts and are not to be used in ordering. Refer to pink insert for prices.	Plate No.
21212	Presser Bar Collar, for Style 14500 D- - - -	5
21225-9/32	Looper Adjusting Gauge, 9/32 inch measurement - - - -	7
21236	Belt Plier, for 3/8 inch and smaller round belt - - - -	15
21262 A	Sewing Head Belt, round, 9/32 inch diameter, 60 inches long, includes wire belt hook No. 21351- - - -	-
21262 B-53	Sewing Head Belt, round, 9/32 inch diameter, 53 inches long, includes wire belt hook No. 21351- - - -	-
21262 C-37	Sewing Head Belt, "V" type, 5/16 inch diameter, 37 inches long, includes wire belt hook No. 21351- - - -	-
21262 D-156	Sewing Head Belt, round, 3/8 inch diameter, 156 inches long, includes wire belt hook No. 21351 A- - - -	-
21351	Belt Hook, wire, for 9/32 inch round belt- -	7
21351 A	" " wire, for 3/8 inch round belt - -	7
21361	Drive Bushing, 1/2 inch long, for presser guide bar bearings, external diameter .407 inch - - - -	7
21362	Drive Bushing, 25/32 inch long, for front presser bar bearing, external diameter .407 inch- - - -	7
21363	Drive Bushing, 1-3/16 inch long, for ear presser bar bearing, external diameter .407 inch- - - -	7
21382 B	Pulley Rim, with 6 inch diameter belt groove, for Style 14500 P (screw No. 22597 A) - - - -	12
21382 C-26	Pulley Rim, with 3 1/4 inches working diameter belt groove, for styles making 4 stitches per inch (screw No. 22569)- - - -	14
21382 C-34	Pulley Rim, with 4 1/4 inch working diameter belt groove, for styles making 3 stitches per inch (screw No. 22569) - - - -	14
21382 E	Pulley Rim, without belt groove, 4 1/2 inches diameter, for Style 14500 R (screw No. 22569) - - - -	14
21388 R	Wrench, double end, 3/8 and 1/2 inch openings - - - -	8
21394	Utility Grinder, including emery wheel, 5 inches diameter, 1/4 inch face, round belt drive, recommended speed 3000 R.P.M. - - - -	-
21394 G	Emery Wheel, 5 inches diameter, 1/4 inch face, 3/8 inch hole, grade "F" emery 60- - - -	-
21394 H	Emery Wheel, 5 inches diameter, 1/2 inch face, 3/8 inch hole, grade "M" emery 60- - - -	-

LIST OF PARTS

Symbol to Order By	The figures in the last column refer only to the plates illustrating the parts and are not to be used in ordering. Refer to pink insert for prices.	Plate No.
21394 K	Utility Grinder, including emery wheel, 5 inches diameter, 1/2 inch face, round belt drive, recommended speed 3000 R.P.M. - - - -	8
21733 A	Lifter Lever Extension (screw No. 22528) - - -	8
22509	Set Screw, square head, cup point, 5/16 inch diameter, 18 threads per inch, for thread stand rods; also for No. 21104 C - - - - -	4
22516	Screw, for knife grinder swinging frame top plate - - - - -	3
22517	▪ for looper differential rocker support	3
22524	▪ for throat plates - - - - -	3
22525	▪ .010 inch plus size; otherwise same as No. 22524 - - - - -	3
22526	▪ plus size .036 inch; otherwise same as No. 22524, tap No. V109 - - - - -	3
22528	▪ for lifter lever extension - - - - -	3
22540	Adapter Screw, with 3/8 inch hole, for upper main shaft bearing lubricating hole - - - -	4
22550	Screw, for maintaining location of cylinder cover - - - - -	3
22560	▪ headless, for needle lever link pin spring - - - - -	3
22563	▪ for feed crank stud cap - - - - -	3
22569	Clamp Screw, for needle bar bearings; also for Nos. 21382 C-26, 21382 C-34, 21382 E - -	3
22570	Screw, for looper eccentric fork shoe; also for No. 15498 P - - - - -	3
22571	Plug Screw, solid, for knock-out hole - - - -	3
22572 A	Clamp Screw, for feed crank link - - - - -	4
22580	Set Screw, for feed lift cam fork; also for No. 291 - - - - -	3
22586 A	Screw, for needle lever connecting rod front bearing valve - - - - -	3
22587	▪ for needle lever connecting rod bearings - - - - -	4
22591	Set Screw, for knife grinder swinging frame	3
22592	Clamp Screw, for looper eccentric fork; also for No. 14674 - - - - -	4
22596	Screw, for feed dogs and needle guard - - - -	3
22597	▪ for needle lever eccentrics - - - - -	3
22597 A	▪ for pulley rim on Style 14500 P - - - - -	3
22632 F-24	▪ square head, cup point, 3/16 inch diameter, 3/8 inch long, 24 threads per inch, for thread stand wire - - - - -	3
22768	▪ for needle bar thread eyelet - - - - -	3
22793	Hinge Screw, for presser foot on Style 14500 D - - - - -	4
22794	Hinge Screw, for presser foot on Styles 14500 F, 14500 H, 14500 P, 14500 R - - - -	4
22823	Screw, for sewing head quick change adapter plate - - - - -	4

LIST OF PARTS

Symbol to Order By	The figures in the last column refer only to the plates illustrating the parts and are not to be used in ordering. Refer to pink insert for prices.	Plate No.
22823 A	Screw, for attaching sewing head to column on Style 14500 R- - - - -	4
28604	Transmitter Lubricant, 5 lb. package, No. 3 arctic cup grease - - - - -	-
28606-1/2	Powdered Oil Stone, 1/2 lb. package - - - - -	-
28606-1	" " " 1 lb. package - - - - -	-
29066 B	Needle Lever Connecting Rod Front Bearing Assembly; one each Nos. 1230 A, 156 lapped together and Nos. 1230 B, 1230 D, 22586 A	6
29089 F	Needle Lever Eccentric Assembly, for Styles 14500 D, 14500 F; one each Nos. 14585 A, 15430 M lapped together - - - - -	9
29089 C	Needle Lever Eccentric, for Styles 14500 H, 14500 P, 14500 R; one each Nos. 14585 B, 15430 M lapped together - - - - -	9
29163 B	Looper Rocker and Looper Avoid Shaft Assembly; one each Nos. 33, 316, 14513 A lapped together and No. 34 - - - - -	15
29333	Needle Lever Assembly; one each Nos. 1275 A, 14515 lapped together and No. 47- - - - -	14
30090 C	Main Shaft Bushing, lower - - - - -	7
35172 D	" " Bearing Spring Valve Oiler, external diameter 21/64 inch - - - - -	5
41046 G	Presser Bar Bearing Spring Valve Oiler- - - - -	5
41078 B	Main Shaft Bearing Spring Valve Oiler, external diameter 27/64 inch - - - - -	5
K47577	Filler Cord Cone Support, for use on bag closing frames in Class 21800 - - - - -	16
K48322	Cylinder, for Style 14500 P (screw No. 318) Note: This part is furnished only when repairs are made at factory.	-
80464	Plug Screw, with 1/4 inch hole, for opening adjacent to upper main shaft bearing- - - - -	4



Union Special[®]

INDUSTRIAL SEWING MACHINES

UNION SPECIAL maintains sales and service facilities throughout the world. These offices will aid you in the selection of the right sewing equipment for your particular operation. Union Special representatives and service men are factory trained and are able to serve your needs promptly and efficiently. Whatever your location, there is a Union Special Representative to serve you. Check with him today.

ATLANTA, GA.

BOSTON, MASS.

CHICAGO, ILL.

DALLAS, TEXAS

LOS ANGELES, CAL.

NEW YORK, N. Y.

PHILADELPHIA, PA.

MONTREAL, QUEBEC

BRUSSELS, BELGIUM

LEICESTER, ENGLAND

LONDON, ENGLAND

PARIS, FRANCE

STUTTART, GERMANY

Representatives and distributors in all important industrial cities throughout the world.

Union Special

MACHINE COMPANY

400 N. FRANKLIN ST., CHICAGO, ILL. 60610